

PFAFF

471

Unterklassen-Ausstattung

Subclass parts

Composition des sous-classes

Composición de las subclases

Table of subclasses
Table des sous-classes
Tabla de subclases **PFAFF 471**

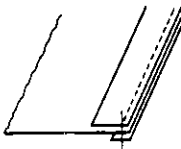
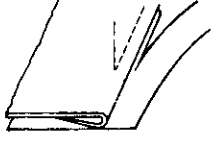
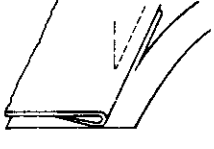
Unterklasse Subclass Sous-classe Subclase	-755/11-59/01	-755/11-900/53	-755/11-725/04-940/02	-755/11-725/04-900/53
Arbeitsgang Operation Opération Opération		Zum Herstellen von Zier- und Befestigungsnahten. Schiebetransport und angetriebener Rollfuß. For sewing fancy seams and assembly seams. Wheel feed and driven roller presser. Pour exécuter les coutures d'ornementation et de fixation. Avec entraînement par roue et pied à roulette entraînée. Para ejecutar costuras de adorno y fijación. Transportador inferior de rueda y pie rodante accionado.		 
Ausführung Model Version Tipo de máquina	A; B	A; B	A (1,0) A B	A; B
Schneidabstand in mm Trimming margin in mm Distance de coupe en mm Margen de corte en mm			A (1,0) = 0,8 A = 1,0 - 2,5 B = 1,2 - 2,5	A = 0,8 - 2,5 B = 1,2 - 2,5
Nadelstange Needle bar Barre à aiguille Barra de aguja	91-119 440-91	91-175 100-91	91-175 100-91	91-175 100-91
Stoffschieber Feed dog Griffe Transportador inferior	91-119 136-05	91-119 136-05	91-119 136-05	91-119 136-05
Stichplatte [4] Needle plate Plaque à aiguille Placa de aguja	91-150 364-03	91-150 605-93/003 [A] 91-150 606-93/002 [B]	91-150 266-93 [A] (1,0) 91-150 278-93 [A] 91-150 337-93 [B]	91-150 605-93 [A] 91-150 606-93 [B]
Rollfuß [4] Roller presser Pied à roulette Pie rodante	91-119 681-93	91-119 787-93	91-119 787-93	91-119 787-93
Fingerschutz Finger guard Protège-doigts Salvadedos	91-053 938-91	91-053 938-91	91-053 938-91	91-053 938-91
Apparat [5] Attachment Appareil Aparato	91-050 859-93			
Bandführung Tape guide Guide-ruban Guiacintas	91-053 984-21			
Bandrollenträger Tape reel bracket Plateau dérouleur Portarollos	91-053 983-71/895 91-041 644-70/895			
Messer [9/2] Knife Couteau Cuchilla			91-119 202-04	91-119 202-04
Lineal Edge guide Guide-droit Guia recta	91-156 262-91 91-056 905-05		91-156 262-91 91-156 114-05	91-156 262-91 91-156 114-05

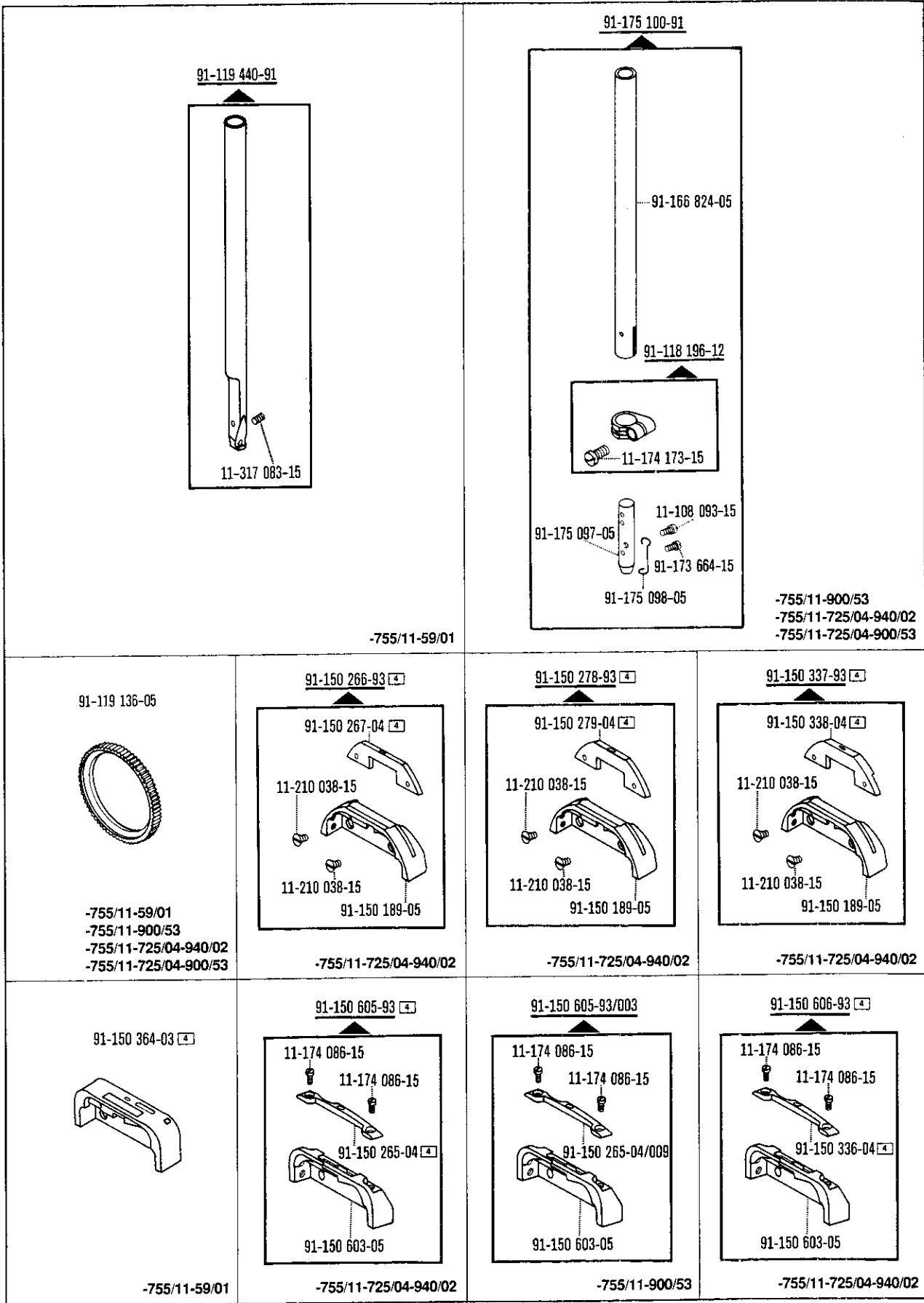

☐ siehe Erläuterungen Register 0
 see explanations in section 0
 voir légende registre 0

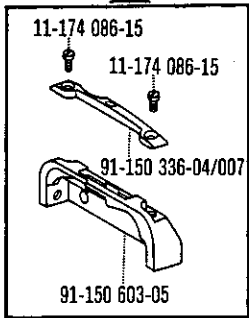
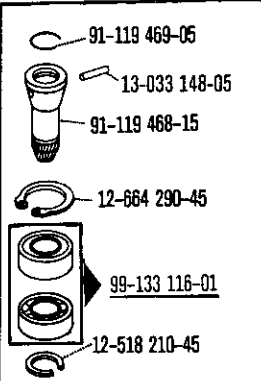
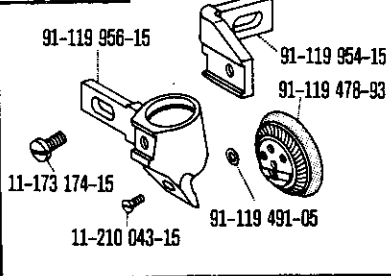
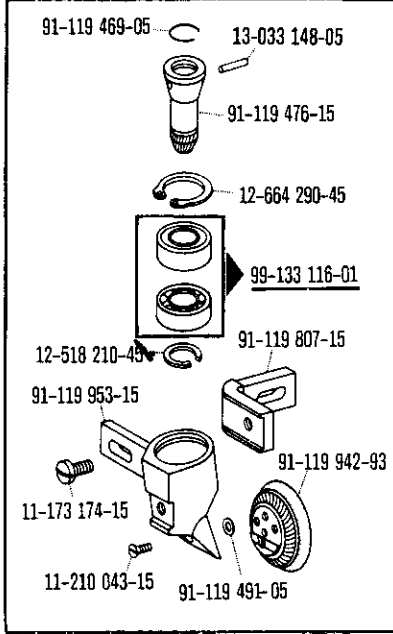
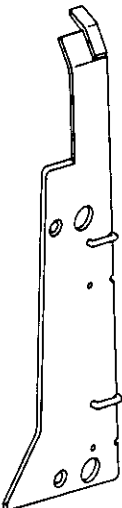
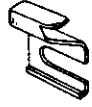
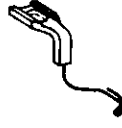
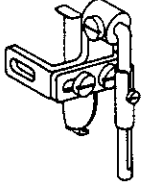
<p>91-150 606-93/002</p>  <p>11-174 086-15 11-174 086-15 91-150 336-04/007 91-150 603-05</p> <p>-755/11-900/53</p>	<p>91-119 681-93 [A]</p>  <p>91-119 469-05 13-033 148-05 91-119 468-15 12-664 290-45 99-133 116-01 12-518 210-45</p>  <p>91-119 956-15 91-119 954-15 91-119 478-93 11-173 174-15 11-210 043-15 91-119 491-05</p> <p>-755/11-59/01</p>	<p>91-119 787-93 [A]</p>  <p>91-119 469-05 13-033 148-05 91-119 476-15 12-664 290-45 99-133 116-01 12-518 210-45 91-119 807-15 91-119 953-15 11-173 174-15 11-210 043-15 91-119 942-93 91-119 491-05</p> <p>-755/11-900/53 -755/11-725/04-940/02 -755/11-725/04-900/53</p>	
<p>91-053 984-21</p>  <p>-755/11-59/01</p>	<p>91-119 202-05</p>  <p>-755/11-725/04-940/02 -755/11-725/04-900/53</p>	<p>91-053 938-91</p>  <p>-755/11-59/01 -755/11-900/53 -755/11-725/04-940/02 -755/11-725/04-900/53</p>	<p>91-060 659-91 [A]</p>  <p>-755/11-59/01</p>

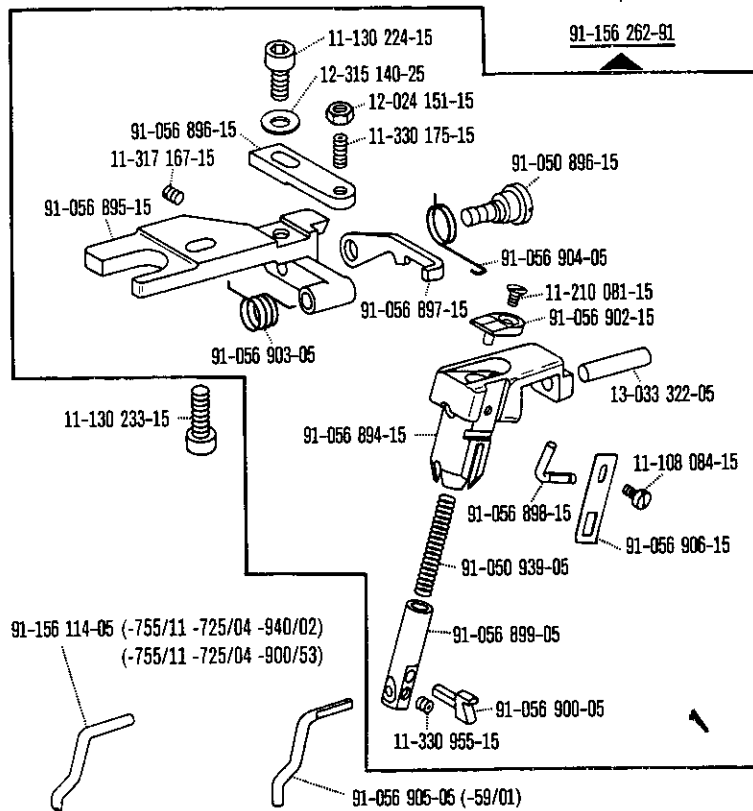

-755/11-59/01
 -755/11-725/04-940/02
 -755/11-725/04-900/53

91-041 644-70/895

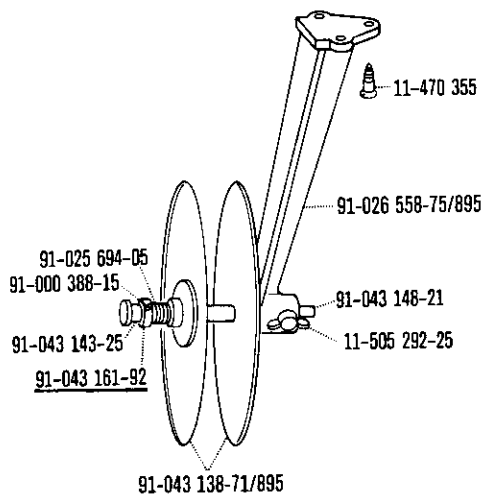

-59/01

91-053 983-71/895

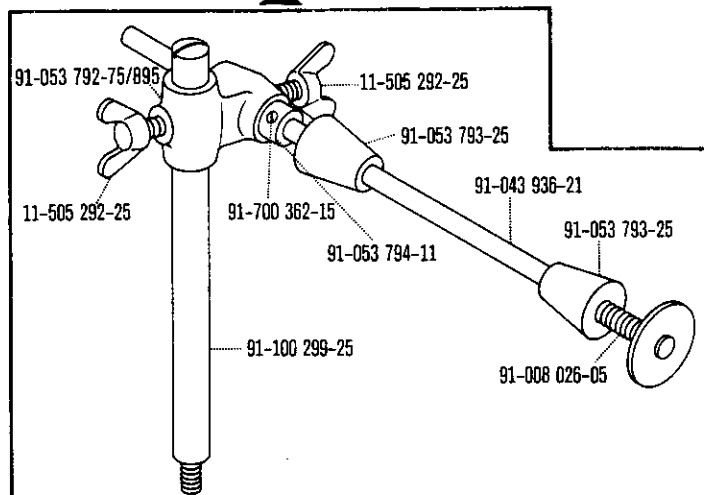

-59/01

PFAFF

**G.M. PFAFF
Aktiengesellschaft**

Postfach 3020
D-67653 Kaiserslautern

Königstr. 154
D-67655 Kaiserslautern

Telefon: (0631) 200-0
Telefax: (0631) 172 02
Telex: 45753 PFAFF D

Gedruckt in der BRD
Printed in Germany
Imprimé en R.F.A.
Impreso en la R.F.A.