

TAIWAN · CHINA · VIETNAM
GREAT KNIVES
MANUFACTURE CO., LTD.

台灣偉群製刀工業(股)公司



We are **SEWING**
Since 1978



Sewing M/C Knives Manufacturer
Industrial Knives Manufacturer

Industrial **Sewing** and **Cutting**
Machine Spare Parts

工業縫紉機及裁布機成品配件

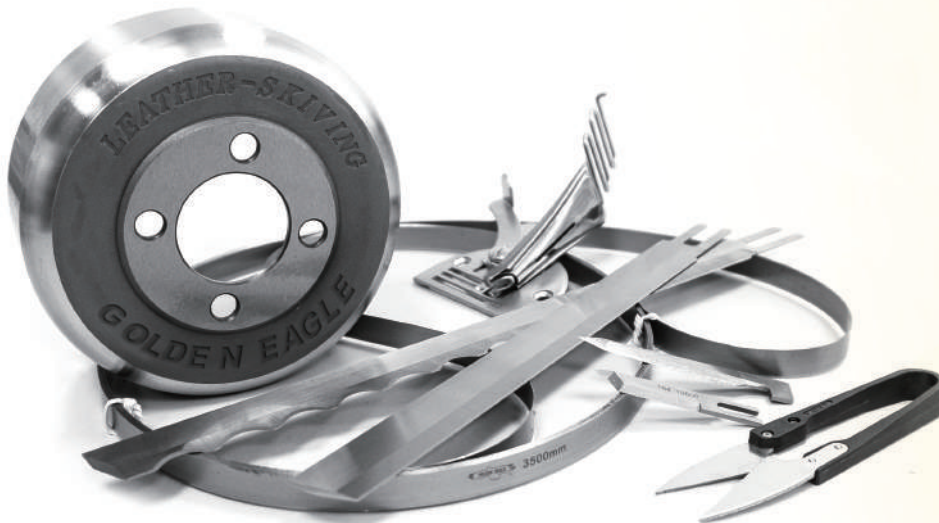



直刀

STRAIGHT KNIFE





STRAIGHT KNIFE - EASTMAN

伊士曼直刀



4E | 5E | 6E | 7E | 8E | 9E | 10E | 11 1/2E | 12E | 13E | 15E

High Speed Steel 高速鋼 Super Alloy Steel 特殊合金鋼 Alloy Steel 合金鋼



4ET | 5ET | 6ET | 7ET | 8ET | 9ET | 10ET | 11 1/2ET | 12ET | 13ET

High Speed Steel 高速鋼 Super Alloy Steel 特殊合金鋼 Alloy Steel 合金鋼

non-stick coating 不粘塗層



6EW | 7EW | 8EW | 9EW | 10EW | 12EW | 13EW

High Speed Steel 高速鋼 Super Alloy Steel 特殊合金鋼 Alloy Steel 合金鋼

WAVE 波刀



5EWT | 6EWT | 7EWT | 8EWT | 9EWT | 10EWT

High Speed Steel 高速鋼 Super Alloy Steel 特殊合金鋼 Alloy Steel 合金鋼

WAVE 波刀 non-stick coating 不粘塗層



High Speed Steel 高速鋼

643C1-44(5in)

643C1-41(6in)

SLIDER ASSEMBLY 刀鞘

643C1-42(7in)

643C1-43(8in)

643C1-46(9in)

643C1-47(10in)

643C1-53(11-1/2in)

643C1-45(13in)



STRAIGHT KNIFE - KM 直刀



4KM(N) | 5KM(N) | 6KM(N) | 6KM | 7KM | 8KM | 9KM | 10KM | 12KM | 13KM | 15KM

High Speed Steel 高速鋼 Super Alloy Steel 特殊合金鋼 Alloy Steel 合金鋼



5KMW | 5KMW(N) | 6KMW | 7KMW | 8KMW | 9KMW | 10KMW

High Speed Steel 高速鋼 Super Alloy Steel 特殊合金鋼 Alloy Steel 合金鋼

WAVE 波刀



High Speed Steel 高速鋼

SLIDER ASSEMBLY 刀鞘

- M-086 5" SLIDER-HSS
- M-086 6" SLIDER-HSS
- M-086 7" SLIDER-HSS
- M-086 8" SLIDER-HSS
- M-086 9" SLIDER-HSS
- M-086 10" SLIDER-HSS
- M-086 13" SLIDER-HSS



STRAIGHT KNIFE - COMET 直刀



5C | 6C | 7C | 8C | 9C | 10C | 11C | 12C

High Speed Steel 高速鋼 Super Alloy Steel 特殊合金鋼 Alloy Steel 合金鋼



6CW | 7CW | 8CW | 9CW | 10CW

High Speed Steel 高速鋼 WAVE 波刀

STRAIGHT KNIFE - HITAKA 直刀



4H | 5H | 6H | 7H | 8H | 9H | 10H

High Speed Steel 高速鋼 Super Alloy Steel 特殊合金鋼 Alloy Steel 合金鋼



5HW | 6HW | 7HW | 8HW | 9HW | 10HW

High Speed Steel 高速鋼 Super Alloy Steel 特殊合金鋼 Alloy Steel 合金鋼

WAVE 波刀



STRAIGHT KNIFE - WOLF 直刀



4W | 5W | 6W | 7W | 8W | 9W | 10W | 14W

High Speed Steel 高速鋼 Super Alloy Steel 特殊合金鋼 Alloy Steel 合金鋼



6WW | 7WW | 8WW | 9WW | 10WW

High Speed Steel 高速鋼 Super Alloy Steel 特殊合金鋼 Alloy Steel 合金鋼

WAVE 波刀

STRAIGHT KNIFE - LIGHTING 直刀



6L | 8L | 10L | 12L | 14L

High Speed Steel 高速鋼 Super Alloy Steel 特殊合金鋼

STRAIGHT KNIFE - KURIS 直刀



6K | 7K | 8K | 10K

High Speed Steel 高速鋼



STRAIGHT KNIFE - MAIMIN 直刀



4M | 5M | 6M | 7M | 8M | 5M | 6M | 7M | 8M | 9M | 10M | 11M | 14M

High Speed Steel 高速鋼 Super Alloy Steel 特殊合金鋼 Alloy Steel 合金鋼



6MW | 7MW | 8MW | 9MW | 10MW

High Speed Steel 高速鋼 Super Alloy Steel 特殊合金鋼 Alloy Steel 合金鋼

WAVE 波刀



High Speed Steel 高速鋼

SLIDER ASSEMBLY 刀鞘

6M-SLIDER-HSS
8M-SLIDER-HSS
9M-SLIDER-HSS
10M-SLIDER-HSS
11M-SLIDER-HSS



圓刀
ROUND KNIFE

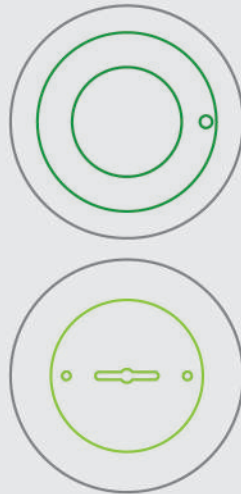



ROUND KNIFE-BEAVER 圆刀

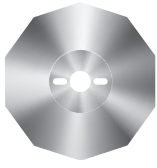

R2-5/16B(10)
59X10.0X1.00



R5 1/4B
R 5 1/4B55
133X50.8X1.20

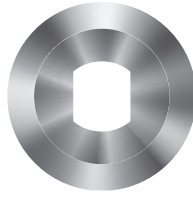

R 6B
152X50.8X1.20

ROUND KNIFE-EASTMAN 伊士曼 圆刀

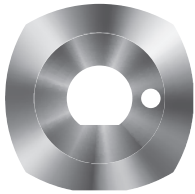

123-HSS
80C1-123
51X16.2X1.05

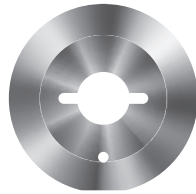

147-HSS
80C1-147
57X16.0X1.10

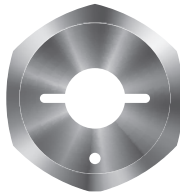

149-HSS
80C1-149
57X16.0X1.05

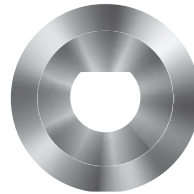

114-HSS
80C1-114
64X22.4X1.00

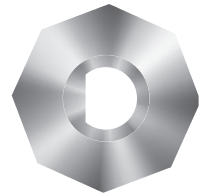

133-HSS
80C1-133
51X16.0X1.20

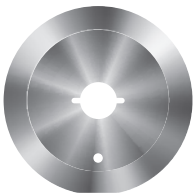

R 4E#141
80C1-141
102X22.2X1.00

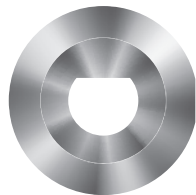

R 4E
80C1-59
102X14.0X1.05

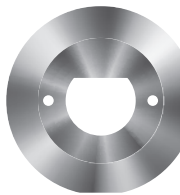

R 5 1/4E
80C1-61
133X52.0X1.05

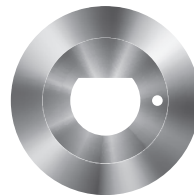

R 5
80C1-101
127X39.6X1.10

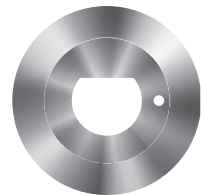

R 6E
80C1-39
152X51.0X1.45



R 7E
178X51.0X1.50

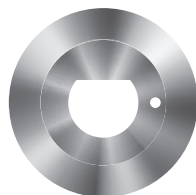

R 7 1/2E
191X51.0X1.90



ROUND KNIFE-HITAKA 圆刀

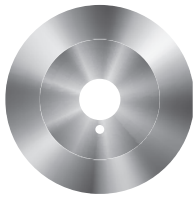

R 2 1/2H
63X12.2X0.80

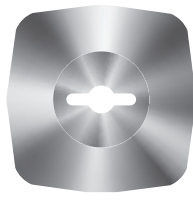

RE-12
66X10.0X1.00

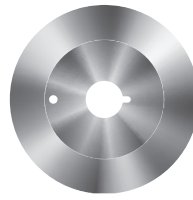

R3 1/2H
89X17.5X0.90



R 5H
127X40.0X1.10

ROUND KNIFE-HOOGS 圆刀



MS-55(7)
115-90
1-MS-55
47X10.0X1.00

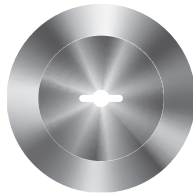

HOOG'S(R)
501-140
1-MS21
110X10.0X1.20

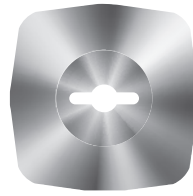

HOOG'S 110m/m
R110-90
3-MS-2
110X10.0X1.60

ROUND KNIFE-KM 圆刀

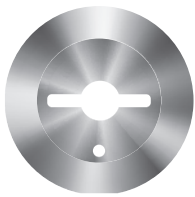

R 2KM
A-113(R)
RS-50
50X10.0X1.25

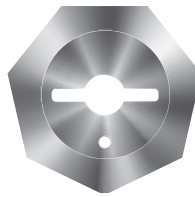

R 2KM(7)
A-113
RS-50(7)
48X10.0X1.05

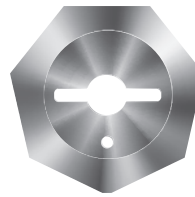

R 2KM(7)-HSS
A-113-HSS
RS-50(7)-HSS
48X10.0X1.05

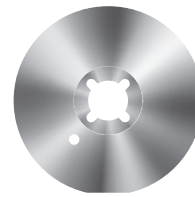

R 4KM
RS-100
100X21.0X1.20

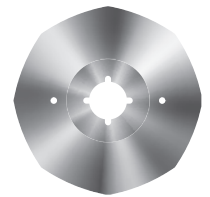

R 4KM(8)
RCS-135(8)
RS-100(8)
100X21.0X1.20

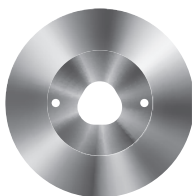

R 5KM-HSS
127X43.0X1.20



R 6KM-HSS
152X50.0X1.50



ROUND KNIFE-KURIS 圓刀

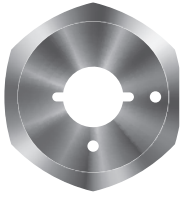

16110(6)
24741(6)
2(6)KURIS
50X16.0X1.00

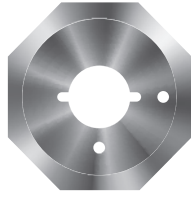

16120(8)
R 2(8)KURIS
50X16.0X1.00

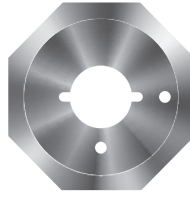

R 2(8)KURIS
50X16.0X1.00

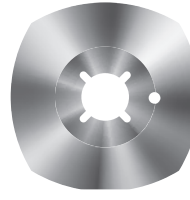

16010(4)
BOM-80(4)
80X16.0X1.00

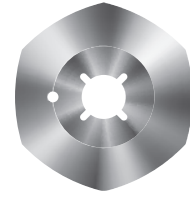

16092(6)
46377(6)
BOM-80(6)
80X22.0X1.00

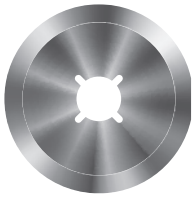

15710
47014
KRH-10
100X35.0X1.20

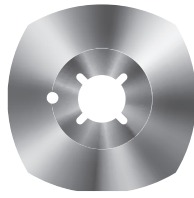

16022(4)
24739(4)
bom-100
BOM-101(4)
100X22.0X1.00

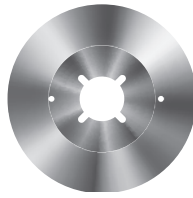

15722
KRH-12
120X35.0X1.20

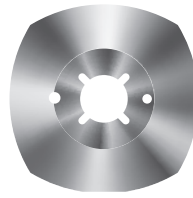

16057(4)
46378(4)
KRH-12(4)
120X35.0X1.50

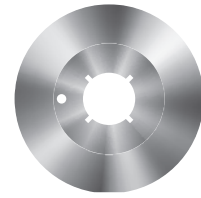

15730
KRH-15
150X35.0X1.50

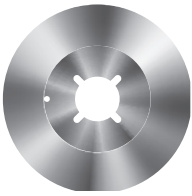

15740
KRH-20
200X40.0X2.20

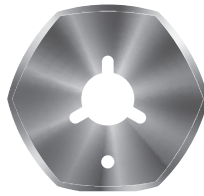

AS 1026
48X13.0X1.00

ROUND KNIFE-MAIMIN 圓刀

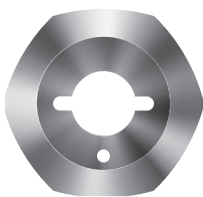

RS-232
50X16.0X1.5

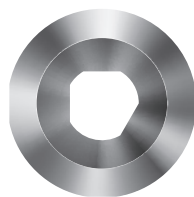

R2 1/2M
64X21.4X0.90

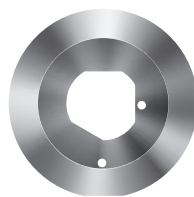

R 4M
102X40.0X1.05

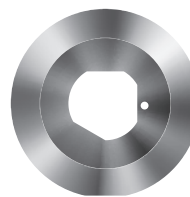

R 5M
127X40.0X1.20

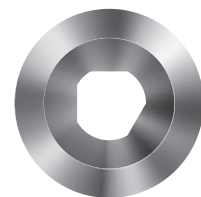

R 5 1/4M
R 5 1/4M59
133X52X1.10

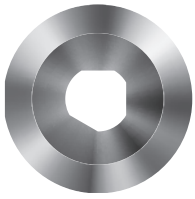

R 6M
152X58.0X1.50

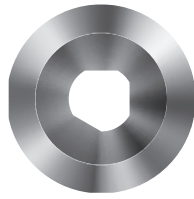

R 7M
178X58.0X1.50

ROUND KNIFE-WOLF 圓刀



1426371
R 2W
PUP
53X17.5X1.01

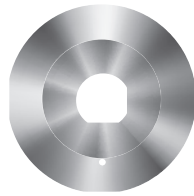

1437070
R 2 1/2W
63X20.5X0.89

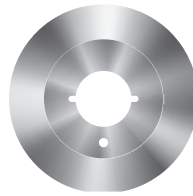

1430770
R 4W
102X31.8X1.04

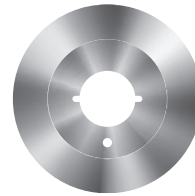

1430370
R 4 3/4W#22
121X42.8X1.10

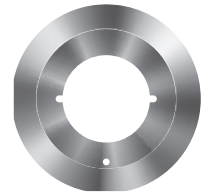

1431170
R 5 1/4W#24
133X50.8X1.04

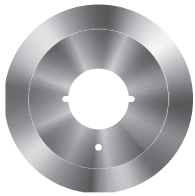

1429970
R 5 1/4W#21
133X42.8X1.00

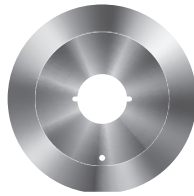

1426970
R 6W NO.16
152X40.1X1.30

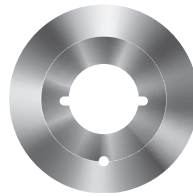

R 6W NO.18
152X50.8X1.30

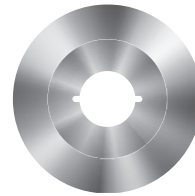

R 7W
178X50.8X1.40

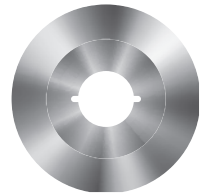

R 8W
203X50.8X1.40



R 10W
254X50.8X1.60



ROUND KNIFE-SUPRENA 圓刀

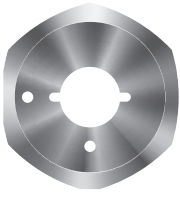

M700(6)
50X16.0X1.00

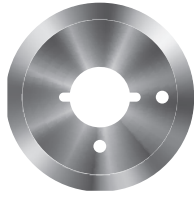

M702
50X16.0X1.00

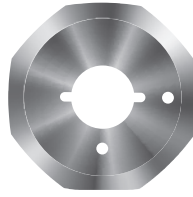

M703(8)
50X16.0X1.00

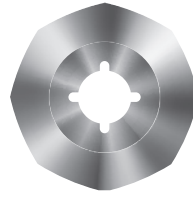

M740(8)
80X22.0X1.00

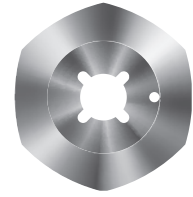

M741(6)
80X22.0X1.00

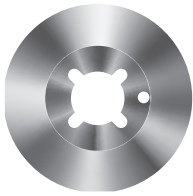

M742
80X22.0X1.00

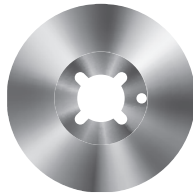

R 1512
100X22.0X1.00

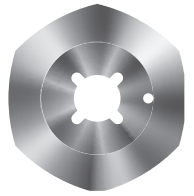

R 1513
100X22.0X1.00

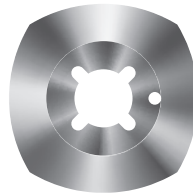

R 1514
100X22.0X1.00

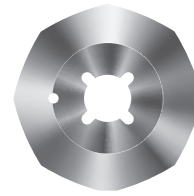

R 1515
100X22.0X1.00

ROUND KNIFE-OTHERS 圓刀



47410
R 28X0.3
28X5.0X0.30



47409
R 45X0.3
45X8.1X0.30

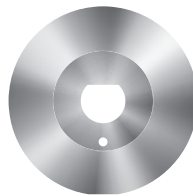

D100
100X22.2X1.05

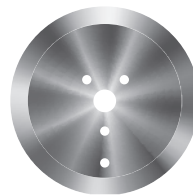

CH141
102X8.0X1.30

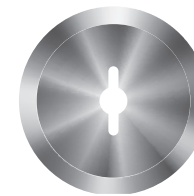

R4 1/4-SKS2
108X10.0X1.20

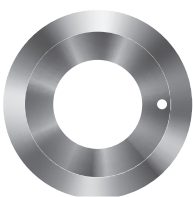

R 80X40X1.0
80X40.0X1.00

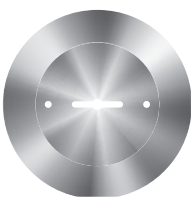

R 4 1/4
108X10.0X1.20



拷克刀
OVERLOCK KNIFE

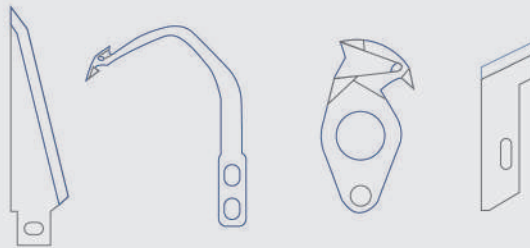

LOWER 下刀
UPPER 上刀
CT 钨钢
MOVING 活动刀
FIXED 固定刀



OVERLOCK KNIFE for BABYLOCK 拷克刀



205-9101-01A
Upper Knife
BL4-605.SL500



205-9102-01A
Lower Knife(CT)
BL4-605.SL500



405-9101-01A
Upper Knife(CT)
SL-600.700



408-9101-01B
Upper Knife
BL3-408.418, SL800



408-9102-01A
Lower Knife
BL3-408.418, SL800



428-9101-01B
Upper Knife
BL4-428.738



60507
Upper Knife(CT)
L330.L803.SL843



60544
Lower Knife
L330.L803.SL843



PL-Q11-01B
Upper Knife
BL4-736

OVERLOCK KNIFE for BROTHER 兄弟 拷克刀



030-0095-00
BASS3200



030-0096-00
BASS3200



030-0097-00
BASS3200



030-0098-00
BASS3200



030-0461-00
BASS3200



127734-0-01
Upper Knife
B523NL,24NL,25NL



112436-0-01
155193-0-01
Lower Knife
B500,B600



118527-0-01
Lower Knife
B500,B600



140242-0-01
Angled Upper Knife(CT)
B500,B600



144074-0-01
Upper Knife (CT)
B500,B600



144074-300
Upper Knife (CT)
EF4-V41



148198-0-01
Upper knife
B500,B600



OVERLOCK KNIFE for BROTHER 兄弟 拷克刀



148815-0-01
Angled Upper Knife (CT)
B500,B600



S20579-101
Angled Upper Knife (CT)
EF4-V41



S20582-001
Lower Knife
EF4-V41



S20583-001
Lower Knife
EF4-V41



S20896-101
Angled Upper Knife (CT)
EF4-V41



S20897-101
Angled Upper Knife (CT)
EF4-V41



S20898-101
Angled Upper Knife (CT)
EF4-V41



S20899-001
Lower Knife
EF4-V41



X05007001
Lower Knife
B523NL,24NL,25NL

OVERLOCK KNIFE for JUKI 重机 拷克刀



115-65900
Angled Upper Knife(CT)
MO-1516G



115-66502
Lower Knife
MO-1516



118-45609
Upper Knife(CT)
MO-2514



118-45708
Upper Knife(CT)
MO-2516



118-45807
Angled Upper Knife(CT)
MO-2514



118-45906
Angled Upper Knife(CT)
MO-2516



118-46003
Lower Knife
MO-23,24,2500



118-47407
Upper Knife
MO-2314



118-47506
Upper Knife
MO-2316



120-04909
Upper Knife(CT)
MO-2516



124-47504
Lower Knife
MO-3300



131-50503
Upper Knife(CT)
MO-6700



OVERLOCK KNIFE for JUKI 重机 拷克刀



131-50602
Upper Knife(CT)
MO-6700



131-50701
Lower knife(CT)
MO-6700



164-16109
Upper Knife
APW-232



164-18709
Upper Knife
APW-232



611325N
Upper Knife
SJ-611



A4113-102-000
Lower Knife
MO-202,234,305



A4142-335-000
Upper Knife(CT)
MO-202,234,305



A4145-335-000
Lower Knife
MO-202,234,305



B4108-352-000
Upper Knife
MO-352,354,357



B4108-352-00B
Upper Knife
MO-352



B4108-352-00B(L)
Upper Knife
MO-352,354,357



B4108-352-00D
Upper Knife(CT)
MO-352,354,357



B4111-804-00A
Angled Upper Knife(CT)
MO-814



B4111-804-00C
Angled Upper Knife(CT)
MO-816



B4118-804-000
Lower Knife
MO-1000



B4118-804-00C
Lower Knife
MO-800



B4122-352-000
Lower Knife
MO-352



B4122-352-00A
Lower Knife
MO-352



B4122-354-00A
Lower Knife
MO-352,354,357



B4122-357-00D
Lower Knife
MO-352,354,357



OVERLOCK KNIFE for KANSAI-SP 关西 拷克刀



07-124
Upper Knife(CT)
B1702,B2000C



07-168
Upper Knife
W8103EMK



07-169
Lower Knife
W8103EMK



07-170
Upper Knife
W8103EMK



07-206
Lower Knife(CT)
B1702,B2000C



07-406
Upper Knife(CT)
B1702,B2000C



07-505
Upper Knife(CT)
WX8103EMK



07-507
Lower Knife
WX8803EMK



07-558
Lower Knife
RX9903EMK



07-570
Upper Knife(CT)
RX9903EMK



07-702
Upper Knife(CT)
B1702,B2000C



07-703
Upper Knife(CT)
B1702,B2000C



07-707
Lower Knife
B1702,B2000C

OVERLOCK KNIFE for MERROW 梅罗 拷克刀



6-90
Upper Knife
1D,2D,3D,4D,5D



6-91
Lower Knife
1D,2D,3D,4D,5D



6-91E
Lower Knife
1D,2D,3D,4D,5D



6-91F
Lower Knife
1D,2D,3D,4D,5D



A-90-7
Upper Knife
1D,2D,3D,4D,5D



A-90-3
Upper Knife
1D,2D,3D,4D,5D



OVERLOCK KNIFE for MERROW 梅罗 拷克刀



S6-91K
Lower Knife
1D,2D,3D,4D,5D



S6-91H
Lower Knife
1D,2D,3D,4D,5D

OVERLOCK KNIFE for NEW HOME



110-1
ML-110-1
Upper Knife
777,778,779



113
ML-113
Lower Knife
777,778,779



784048
784045001
Lower Knife(CT)
203,234,234D,334



784045
784045008
Upper Knife
203,234,234D,334

OVERLOCK KNIFE for PEGASUS 飞马 拷克刀



3543
Lower Knife
1301,1311



3544A
Upper Knife
1301,1311



137562
Lower Knife
DCM203,204



138559
Upper Knife
DCM203,204



200971
Upper Knife(CT)
DCM204



201121A
Upper Knife(CT)
E Series



201121ANS
Upper Knife(CT)
E Series



201127
Lower Knife
E Series



202295
Lower Knife
L Series



202527
Upper Knife(CT)
L Series



202527A
Upper Knife(CT)
L Series



202570
Upper Knife
R Series



OVERLOCK KNIFE for PEGASUS 飞马 拷克刀



202572
Lower Knife
L Series



202573
Lower Knife
E Series



202893
Lower Knife(CT)
R Series



204161
Lower Knife
L,E Series



204161A
Lower Knife
W664-35



204351
Lower Knife(CT)
E Series



205258
Upper Knife(CT)
R Series



205890
Upper Knife(CT)
R Series



210755(CT)
Angled Upper Knife(CT)
EX5200



211662
Angled Upper Knife(CT)
EX5214H



CT-277000
Upper Knife(CT)
EX Series



277009
Lower Knife
EX Series



2B0010
W2600-35B
W1662-35B



306394
Upper Knife(CT)
W500



312-870-001
Lower Knife
1301.1311



312-870-003
Upper Knife
1301.1311



323-870-005
Upper Knife(CT)
L Series

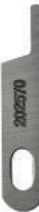

323-870-200
Upper Knife
R Series



323-870-202
Lower Knife
L Series



323-870-203
Lower Knife
E Series



323-870-207
Upper Knife(CT)
L Series



323-870-210
Lower Knife
L Series



323-870-211
Lower Knife
E Series



323-870-212
Lower Knife(CT)
R Series



OVERLOCK KNIFE for PEGASUS 飞马 拷克刀



323-870-213
Lower Knife
L, E Series



323-870-214
Upper Knife(CT)
E Series



323-870-215
Lower Knife(CT)
R Series



323-870-218
Lower Knife(CT)
E Series

OVERLOCK KNIFE for RIMOLDI 利满地 拷克刀



202142-0-10
Angled Upper Knife
329.529.627.629



202143-0-10
Angled Upper Knife
329.529.627.629



202146-0-10
Lower Knife
329.529.627.629



202932-0-10
Angled Upper Knife
329.529.627.629



203010-0-10
Angled Upper Knife
329.529.627.629



203012-0-10
Lower Knife
329.529.627.629



203066-0-10
Angled Upper Knife
329.529.627.629



203069-0-10
Lower Knife
329.529.627.629



203144-0-10
Lower Knife
329.529.627.629



203759-0-10
Angled Upper Knife
329.529.627.629



203783-0-10
Angled Upper Knife
329.529.627.629



204693-0-10
Lower Knife
329.529.627.629



204693-0-11
Lower Knife
329.529.627.629



207000-2-00
Angled Upper Knife(CT)
329.529.627.629



207001-2-00
Angled Upper Knife(CT)
329.529.627.629



207002-2-00
Angled Upper Knife(CT)
329.529.627.629



207003-2-00
Angled Upper Knife(CT)
329.529.627.629



207004-2-00
Angled Upper Knife(CT)
329.529.627.629



OVERLOCK KNIFE for RIMOLDI 利满地 拷克刀



207006-2-00
Angled Upper Knife(CT)
329.529.627.629



207015-2-00
Lower Knife(CT)
329.529.627.629



207016-2-00
Lower Knife(CT)
329.529.627.629



207017-2-00
Lower Knife(CT)
329.529.627.629



207020-2-00
Lower Knife(CT)
329.529.627.629



207020-2-01
Lower Knife(CT)
329.529.627.629



270-112
Angled Upper Knife
329.529.627.629



270-112/1
Angled Upper Knife
329.529.627.629



270-113
Lower Knife
627



270-113/1
Lower Knife
329.529.627.629



2701P9-113/1
Lower Knife
329.529.627.629



276B-112
Angled Upper Knife
329.529.627.629



277-112
Angled Upper Knife
329.529.627.629



277-113
Lower Knife
329.529.627.629



2777-112
Angled Upper Knife
329.529.627.629



2777-1121
Angled Upper Knife
329.529.627.629



279-112
Angled Upper Knife
329.529.627.629



279-113/1
Lower Knife
329.529.627.629



290-112
Angled Upper Knife
329.529.627.629



290-113
Lower Knife
329.529.627.629



290-113SP
Angled Upper Knife
329.529.627.629



302807-0-10
Upper Knife
261.2.3.4.5



302808-0-10
Lower Knife
261.2.3.4.5



6378-112
Upper Knife
261.2.3.4.5



OVERLOCK KNIFE for RIMOLDI 利满地 拷克刀



6378-113
Lower Knife
261.2.3.4.5



CT270-112
Angled Upper Knife(CT)
329.529.627.629



CT270-113/1
Lower Knife(CT)
329.529.627.629



CT276B-112
Angled Upper Knife(CT)
329.529.627.629



CT277-112
Angled Upper Knife(CT)
329.529.627.629



CT277-113
Lower Knife(CT)
329.529.627.629



CT2777-112
Angled Upper Knife(CT)
329.529.627.629



CT2777-1121
Angled Upper Knife(CT)
329.529.627.629



CT279-112
Angled Upper Knife(CT)
329.529.627.629



CT279-113/1
Lower Knife(CT)
329.529.627.629



CT290-112
Angled Upper Knife(CT)
329.529.627.629



CT290-113
Lower Knife(CT)
329.529.627.629



CT290-113SP
Lower Knife(CT)
329.529.627.629



CT302865-0-11
Upper Knife(CT)
261.2.3.4.5

OVERLOCK KNIFE for SINGER 胜家 拷克刀



42305
Upper Knife
81.81K.81V



42309
Lower Knife
81.81K.81V



164037
Lower Knife
246K.460K.992B



164233
Lower Knife
246K.460K.992B



164308
Angled Upper Knife
246K.460K



164550
Angled Upper Knife
246K.460K



OVERLOCK KNIFE for SINGER 胜家 拷克刀



164556
Angled Upper Knife
246K,460K



164728
Lower Knife
246K,460K,992B



164809
Lower Knife(CT)
246K,460K,992B



164813
Lower Knife(CT)
246K,460K,992B



410295
Lower Knife
U12,U32,U52,U53



412544
Lower Knife(CT)
U12,U32,U52



412585
Lower Knife(CT)
U12,U32,U52



412749
Lower Knife
U12,U32,U52,U53



CT164728
Lower Knife(CT)
246K,460K,992B

OVERLOCK KNIFE for SIRUBA 银箭 拷克刀



B
Lower Knife
737,747,757



KR-23
Upper Knife(CT)
737,747,757



KR-23A
Upper Knife(CT)
737,747,757



KR-23C
Lower Knife(CT)
757E



KR-35
Lower Knife
737,747,757



KR-35C
Lower Knife
757E

OVERLOCK KNIFE for TOYOTA 丰田 拷克刀



1250004-229B
Upper Knife
6300,6600

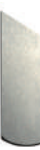

1250004-237B
Lower Knife
6300,6600



1250014-229
Upper Knife(CT)
6300,6600



1270004-229
Upper Knife(CT)
6300,6600



1650004-229
Upper Knife(CT)
6300,6600



OVERLOCK KNIFE for TOYOTA 丰田 拷克刀



5140008-413
Fixed Knife
EK1



5150002-321
Needle Guard
EK1



5150002-323
Needle Guard
EK1



5150002-324
Needle Guard
EK1



5150007-311
Upper Knife(CT)
EM1



5150007-321
Lower Knife
EK1



5140008-413
Movable Knife
EK1

OVERLOCK KNIFE for UNION-SP 友联 拷克刀



28964
Upper Knife
36200



36250
Lower Knife
36200



36270
Upper Knife
36200



39549
Lower Knife
39500



39570
Angled Upper Knife
39500



39270A
Upper Knife
36200



39549J
Lower Knife
39500



39549N
Lower Knife(CT)
39500



39570J
Angled Upper Knife
39500



39570K
Angled Upper Knife
39500



CT39549
Lower Knife(CT)
39500



CT39549J
Lower Knife(CT)
39500



OVERLOCK KNIFE for UNION-SP 友联 拷克刀



CT39570

Angled Upper Knife(CT)
39500



CT39570J

Angled Upper Knife(CT)
39500

OVERLOCK KNIFE for YAMATO 大和 拷克刀



20491

Angled Upper Knife(CT)
Z1000



20493

Upper Knife
Z1000



20496

Upper Knife(CT)
Z6000.Z8000



2100167

Lower Knife
Z6000.Z8000



2101155

Fixed Knife(CT)
K1.AZ8500



2101156

Moving Knife(CT)
K1.AZ8500

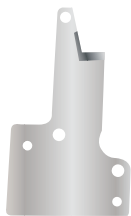

2111055

Lower Knife
AZ-8000 (K2)



2111056

Upper Knife
AZ-8000 (K2)

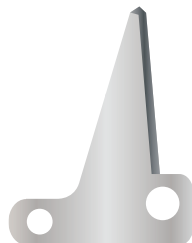

2114012

Movable Cutting Knife
MC.AZ8500



2114013

Fixed Cutting Knife
MC.AZ8500



2121111

Lower Knife
AZX-8600



22195

Lower Knife
Z1000



30421

Lower Knife
DCY.DCZ



32914

Upper Knife(CT)
DCY.DCZ



35285

Lower Knife
DCY.DCZ



35286

Angled Upper Knife(CT)
DCY.DCZ



37469

Upper Knife
DCY-104



37469-HSS
Lower Knife
DCY-104



OVERLOCK KNIFE for YAMATO 大和 拷克刀



37472-HSS
Upper Knife
DCY-104



37472
Lower Knife
DCY-104



37514
Upper Knife
DCY.DCZ



37538
Lower Knife
DCY.DCZ



6200022
Upper Knife(CT)
YAMATO



6200097
Lower Knife
YAMATO



6200308 (2150256)
Upper Knife(CT)
AZ8500



95276
Upper Knife(CT)
VC3800.VC2700



95277
Lower Knife
DW-1200.1400

OVERLOCK KNIFE for OTHERS 其他 拷克刀



0246002553
Top Knife
DURKOPP 745.749



0746060689
Upper Cutting Knife R
DURKOPP 746.748



0746060691
Upper Cutting Knife R
DURKOPP 746.748



0746060692
Upper Cutting Knife L
DURKOPP 746.748



21-5602
Top Knife
L.C.A./EAGLE



300417
Lower knife(CT)
HL603A.604.794



DSK-25
Lower knife Side
Cutter



DSK-27
Upper knife Side
Cutter



11442
Lower knife (CT)
300,340,340D



X05007001
Lower knife
M435,M435C,M530



127734001
Upper Knife
M435,M435C,M530



755106
Upper Knife



755128
Lower knife



RL-SL-261416

LOWER KNIFE for ROUND KNIFE 圆刀下刀



261416-2
R4 1/4-CT(2)
2615
Lower Knife
35X9.6



R4 1/4-CT(2-2)
Lower Knife
34.7X9.6



R4 1/4-CT
Lower Knife
34.7X9.6



A-114
RS-50-CT
Lower Knife



ACE(Upper)
08-282
471
Strip Cutter



ACE(Lower)
08-281
470
Strip Cutter



切线刀

TRIMMING KNIFE

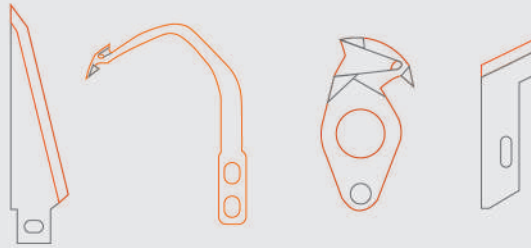

LOWER 下刀

UPPER 上刀

CT 钨钢

MOVING 活动刀

FIXED 固定刀



TRIMMING KNIVES for ADLER 切线刀



129-17-185-3
91-171853-05
Counter knife 1296

TRIMMING KNIVES for BROTHER 兄弟 切线刀



105306-101
Thread Cutter Plate
B925



105307-101
Thread Cutter
B925



140888-001
Thread Cutter
B500



141509-101
141509-001
Upper Thread Trimming
Ass. B814



141512-001
Upper Thread
Middle Blade B814



141513-001
Upper Thread Upper
Blade B814



141541-0-01
Moving Knife
B814.B815



141543-0-01
Fixed Knife
B814.B815



152897-0-01
Knife Conn. Rod
B430



152901-0-01
Moving Knife
B430



152905-0-01
Fixed Knife
B430



152906-0-01
Thread Retainer
B430



152981-0-01
Knife Arm
B430



153020-001
Fixed Knife
BAS-610



154568-001
Fixed Knife
716-400



159274-001
Moving Knife
LH4-B815



159276-201
Fixed Knife
LH4-B815



159540-001
Moving Knife
LH4-B791-430



TRIMMING KNIVES for BROTHER 兄弟 切线刀



159541-001
Fixed Knife
LH4-B791-430



S02374-001
Fixed Knife
BAS-326



S02375-001
Moving Knife
BAS-326



S02637-001
Fixed Knife
B737



S02643-001
Moving Knife
B737



S02645-001
Moving Knife
B737



S02646-001
Moving Knife
S-7200A



S03627-001
Fixed Knife
B917



S03629-001
Moving Knife
B917



S07526-001
Moving Knife
B842.875



S07526-201
Moving Knife
B842.875



S07527-001
Fixed Knife
B842.875



S08302-001
Comer Knife (S-Left)
BAS-610.1.3A



S08322-001
Comer Knife (S-Right)
BAS-610.1.3A



S09075-001
Lower knife
FD4-B270



S09093-001
Upper knife(CT)
FD4-B270



S09094-001
Upper knife(CT)
FD4-B270



S09101-001
Lower knife
FD4-B270



S10205-001
Moving Knife
BAS-311A



S10210-101
Knife
BAS-311A



S10210-101
Knife
BAS-311A



S10210-201
Fixed Knife
B430E



S16248-001
Top Knife
BAS-610



S19824-001
Needle Thread Trimming
Ass. LH4-815



TRIMMING KNIVES for BROTHER 兄弟 切线刀



S20118-001
Trimming Knife
V-41



S28348-001
Upper Knife Left(CT)
FD3-B256



S28352-001
Lower Knife
FD3-B256



S28650-201
Lower Knife
FD3-B256



S28654-001
Upper Knife
FD3-B256



S34895-001
Fixed Knife
RH-9820



S34899-001
Movable Knife Assy
RH-9820



S35029-001
Upper Movable Knife A
RH-981A



S35437-101
Buttonhole Knife
981



S37671-101
Moving Knife L L3
RH-981A



S37672-101
Moving Knife L L4
RH-981A



S37675-101
Moving Knife L L3
RH-981A



S37676-101
Movable Knife R L1
RH-981A



S37723-001
Moving Knife
981



S49988-001
Movable Knife
BAS-016B



S50113-101
Upper Thread Trimmer
HE-800



S50258-101
Lower Thread Retainer
HE-800A



S50259-101
Lower Thread Retainer
HE-800A



S50260-101
Lower Fixed knife
HE-800A



S50263-001
Moving Knife
HE-800A



S50265-001
Lower Thread Clamp Plate
HE-800A



S50270-000
Lower Thread Presser
HE-800A



S50404-101
Upper Thread Trimmer Assy
HE-800A



S56370-001
Moving Knife(Lower)
HM8180



TRIMMING KNIVES for BROTHER 兄弟 切线刀



S56917-001
Fixed Knife (Lower)
HM-8180



SB1189-001
Movable Knife F Assy
KE-430F



SB1191-101
Fixed Knife F Assy
KE-430F



SA3330-001
Moving Cutting Knife
KE430D



SA3335-001
Fixed Cutting Knife
KE430D



SA3656-101
Moving Cutting Knife
KE430D



SA3658-001
Fixed Cutting Knife
KE430D



SA6596-001
Movable Knife Set F-SCS
KE-430D



SA6597-001
Fixed Knife Set F-SC
KE-430D



SA6988-001
Movable Knife R
RH-9820



SA6989-001
Movable Knife L
RH-9820



THREAD-260
Thread Cutter
B755



THREAD-755
Thread Cutter
B831

TRIMMING KNIVES for JUKI 重机 切线刀



100-01709
Take-Up Thread Cutter
LZ-2280



102-11100
Moving Knife
LH-1162



102-11209
Fixed Knife
LH-1162



102-11605
Moving Knife
LH-3168



107-26305
Moving Knife
LU-2216N-7



110-40052
Moving Knife
DDL-5550H



TRIMMING KNIVES for JUKI

重机 切线刀



110-40201

DDL-5550H



110-42652

DDL-5550NH



110-93259

Moving Knife
DDL-5550-H-6



110-95403

Knife Thread Guide
DDL-5550N-7



113-13053

Moving Knife
DLN-5410-6



113-51400

Moving Knife
DU-141-5



113-51509

Fixed Knife
DU-141-5



114-09257

Moving Knife
DDL-5550H-6



114-09604

Fixed Knife
DDL-5550H-6



124-19602

Chain Cutter Knife
MO-3300



129-22704

Chain Cutter
MS-1190,1260



131-16702

Chain Cutter
MO-6700



137-31161

Needle Thread Trimmer
LBH-790,1700



137-35469

Trimmer, Upper Asm.
LBH-1790



137-35956

Trimmer, Upper Asm.
LBH-790,1700



137-36103

Tension Spring
LBH-790,1700



137-35451

Trimmer, Lower Asm.
LBH-790,1700



140-41206

Buttonhole Knife
3200 38mm



164-03008 (1.0)

APW-192/195



16409906

APW-895



166-07301

Corner Knife H.S.S. (A-1)
APW-192



166-07400

APW-192



166-07509

APW-192



166-07608

APW-192



TRIMMING KNIVES for JUKI 重机 切线刀



166-07707
Corner Knife H.S.S. (C-1)
APW-192



166-07806
Corner Knife H.S.S. (C-2)
APW-192



226-55302
Fixed Knife
LH-3168



235-06009
Cloth Cutting Knife
LZ-2280N



235-06108
Throat Plate Knife
LZ-2280N



303-65407
Fixed Knife
MFC-7605



305-00300
Moving Knife
MFC-7605



320-16107
Lower Thread Cutter Knife
MEB-3200



320-18012
Moving Knife
MEB-3200



320-18509
Fixed Knife
MEB-3200



320-20505
Thread Cutter Lower Knife
MEB-3200



320-20604
Thread Cutter Upper Knife
MEB-3200



320-20703
Thread Cutter Upper Knife
MEB-3200



320-20919
Thread Cutter Upper Knife
MEB-3200



320-23210
Thread Cutter Upper Knife
MEB-3200



320-23319
Thread Cutter Knife
MEB-3200



32063208(16m/m)
Thread Cutter Knife
MEB-3200



32063109(18m/m)
Thread Cutter Knife
MEB-3200



32063000(20m/m)
Thread Cutter Knife
MEB-3200



34749A
Upper Knife
MFC-7700, MF7000



34770AH
Lower Knife
MFC-7700, MF7000



40026155
DDL-9000A/B



40050589
DDL-9000A/B



40089755
DDL-8700J-7



TRIMMING KNIVES for JUKI 重机 切线刀



400-04255
Needle Thread Trimming Ass.
LBH-1790



400-04311
BT. Trimmer
LBH-1790



400-12403
Driving Knife
LH-3528-7



400-12404
Fixed Knife
LH-3528-7



400-15996
Thread Cutter Upper Knife
MEB-3200



400-38091
Fixed Knife
MF-7700



400-38754
Moving Knife
MF-7700



400-39364
Moving Knife
MF-7800



400-42378
Fixed Knife
MF-7800



400-76709
LH-3528-7



B1130-026-000
Trimming Blade
MS-261



B1131-026-000
Trimming Blade
MS-261



B1528-380-OAO
MH-380



B1528-804-000A
Chain Cutter Knife
MO-2500



B1528-804-000
Chain Cutter Knife
MO-2500



B1530-352-000
Thread Cutter
MO-352.357



B2001-761-OAO
Needle Thread Trimming Ass.
LBH-761



B2001-762-OAO
Needle Thread Trimming Ass.
LBH-762



B-2001-771-OAO
Needle Thread Trimming Ass.
LBH-771



B-2002-761-OAO
Upper Thread Trimming Blade
LBH-761



B-2002-771-OAO
Upper Thread Trimming Blade
LBH-771



B2003-761-000
Needle Thread Tension Spring
LBH-761



B2003-771-000
Needle Thread Tension Spring
LBH-771



B2406-373-OAO
Moving Knife
MB-373



TRIMMING KNIVES for JUKI 重机 切线刀



B2406-761-OAO
Counter Knife
LBH-761



B2406-771-OAO
Counter Knife
LBH-761



B2408-761-000
Counter Knife
LBH-761



B2408-771-000
Counter Knife
LBH-761



B2410-373-000
Fixed Knife
MB-373



B-2421-205-OAO
Moving Knife
AMS-210



B-2421-210-000
Moving Knife
AMS-210



B2421-210-AAO
Moving Knife
AMS-212



B2424-210-000
Fixed Knife
AMS-210



B2424-210-AOO
Fixed Knife
AMS-212



B2421-280-0A0
Moving Knife
Lk-280,980,1850



B2421-280-000
Moving Knife
Lk-280,980,1850



B2424-280-000
Fixed Knife
Lk-280,980,1850



D2402-555-BA0
Moving Knife
DDL-555-2.3.4.5



D2406-555-B00
Fixed Knife
DDL-555-2.3.4.5



D2406-555-DOH
Fixed Knife
DDL-5550H



D2423-141-E00
Moving Knife
DU-141-5



D2424-141-E00
Fixed Knife
DU-141-5



MAS-11012000
Upper Knife, Left
MFB-860,2600



MAS-11013000
Upper Knife, Right
MFB-860,2600



MAS-11016000
Lower Knife, Left
MFB-860,2600



MAS-11017000
Lower Knife, Right
MFB-860,2600



TRIMMING KNIVES for MITSUBISHI 三菱 切线刀



MF00A0834
Moving Knife
LS2-180



MF00A0838
Fixed Knife
LS2-180



MF02A0834
Moving Knife
LS2-180



MS03A0838
Fixed Knife
PLK-1006



MF40A2835
Right Knife
DB-189



MF40A1835
Right Knife
DB-189



MF40A1834
Left Knife
DB-189

TRIMMING KNIVES for NEW LONG 纽朗 切线刀



246061
Moving Knife
NP-7



246071
Fixed Knife
NP-7



A-121-1
Thread Cutter
1D,2D,3D,4D,5D

TRIMMING KNIVES for MERROW 梅罗 切线刀

TRIMMING KNIVES for PEGASUS 飞马 切线刀



201308P
Chain Cutter knife
E Series



202451
Chain Cutter knife
DCM



236606
Upper Knife
FS.FV.FW Series



236608
Lower Knife
FS.FV.FW Series



257573
Upper knife(CT)
W664-05



257573A
Upper knife(CT)
W664-33B



TRIMMING KNIVES for PEGASUS 飞马 切线刀



257574
Upper Knife(CT)
W664-35



323-873-001
Chain Cutter Knife
E Series



323-873-200
Chain Cutter Knife
DCM



350018-91
Fixed Cutting Knife
W762/UT



350024
Moving Cutting Knife
W762/UT



350218
Moving Knife
W664



350220
Fixed Knife
W664

TRIMMING KNIVES for PFAFF 百福 切线刀



91-171853-05
Counter Knife
480

TRIMMING KNIVES for REECE 利是 切线刀



10-4600-0-000
Upper Thread Trimming
101



32-2047-1-001
Left Knife
32.46.47.48



32-2047-1-002
Right Knife
32.46.47.48



32-2048-1-001
Left Knife
32.46.47.48



32-2048-1-002
Left Knife
32.46.47.48



40-0012-1-045
Center Knife
31.32.42.46.47



TRIMMING KNIVES for REECE 利是 切线刀



40-0012-2-045
Center Knife
31.32.42.46.47



40-0127-1-000
Tab Knife
31.32.42.46.47



40-0127-2-000
Tab Knife
31.32.42.46.47



42-0012-0-045
Center Knife
31.32.42.46.47



48-1125-5-721
Top Knife
32.46.47.48

TRIMMING KNIVES for RIMOLDI 利满地 切线刀



202194-0-10
Thread Cutter Knife
329.629



270-188
Thread Cutter Knife
329.629

TRIMMING KNIVES for SINGER 胜家 切线刀



164861
Chain Cutter Knife
246K.460K



414029
Stationary Knife
591B.D.E



414030
Underbed Trimmer
491D.591D.601D



55459
Shuttle Thread Knife
269W.270



540741
Underbed Trimmer
491D.591D.601D



540760
Stationary Knife
491D200

TRIMMING KNIVES for SIRUBA 银箭 切线刀



A702
Trimming Blade
AA



A703
Trimming Blade
AA



BK-10F
Fixed Knife
747.757



CRL03
Upper knife(CT)
C007E/CRL



CR26J
Fixed Knife(CT)
F007



CR26H
Fixed Knife(CT)
C007E/CRL



TRIMMING KNIVES for SIRUBA 银箭 切线刀



CRL03H
Fixed Knife(CT)
C007E/CRL



CRL03J
Fixed Knife(CT)
C007E/CRL



CRL09J
Lower Knife
C007J



FBQ30
Lower knife(CT)
F007E/FBQ



FR34
Fixed Knife(CT)
F007/FBQ



FR34B
Upper Knife(CT)
F007E/FBQ



FR40
Lower knife(CT)
F007E/FBQ



FR40J
Lower knife
F007



FR40D
Lower knife(CT)
F007E/FB(D)



FR134
Upper knife(CT)
F007



LU02
Moving Knife
L818F



LU05
Fixed Knife
L818F



LU101
Movable Cutting Knife



LU103
Fixed Cutting Knife



LU501
Movable Cutting Knife



LU503
Fixed Cutting Knife



LU602
Moving Knife



LU605
Fixed Knife



KS-24
Chain Cutter knife
737.747.757



UT506
Fixed Knife
C007/UTR1



UT507
Moving Knife
C007/UTR1



TRIMMING KNIVES for SUNSTAR 日星 切线刀



10-001A-2700
Fixed Knife
KM-250



10-101A-2700
Fixed Knife
KM-250



10-001A-64L7
Fixed Knife
KM-640



10-005A-2700
Fixed Knife
KM-250



10-006A-235B
Fixed Knife
KM-250



10-106A-2700
Fixed Knife
KM-250

TRIMMING KNIVES for TAJIMA 田岛 切线刀



AT0204000000
Moving Knife



EG0204000000
Fixed Knife



FX0227000000
Moving Knife



FX0228000000
Fixed Knife

TRIMMING KNIVES for TOYOTA 丰田 切线刀



2111407-553B
Moving Knife
AD-158



2111417-556B
Fixed Knife
AD-158



TRIMMING KNIVES for YAMATO 大和 切线刀



20271
Chain Cutter Knife
AZ-8000



68121
Lower Knife
FD-62



68184
Upper Knife
FD-62



82012
Cutting Knife
CM251.351



94411
Moving Knife
DV,DW-1200,1400



94417
Fixed Knife
DV,DW-1200,1400



95399
Knife



3021109
Lower Knife
FD-62-12



3021111
Upper Knife
FD-62-12



3100512
Fixed Knife
VC Series



3100513
Moving Knife
VC Series



3100708
Movable Trimming Knife
VC-2700



3101026
Lower Knife
VC-2685



3101028
Upper Knife(CT)
VC-2685



3101465
Upper Knife(CT)
VC-2629



3101633
Lower Knife
VC3800,VE2700



3101699
Lower Knife
VC2700



3101700
Upper Knife
VC-2700



3101801
Moving Knife
VC-2700



3101802
Fixed Knife
VC-2700



3110037
Upper Knife(CT)
VC-3611



3110038
Lower Knife
VC-3611



3021060
Knife
FD62-01



3021061
Knife
FD62-01



TRIMMING KNIVES for YAMATO 大和 切线刀



3201062
Lower Knife
VC3800,VC2700



3501032
Angled Upper(CT)
VC-2700



3501535
Angled Upper(CT)
VG-3721



3501026
Lower Knife
VG2735



3501597
Angled Upper(CT)
VG-3721

TRIMMING KNIVES for UNION-SP 友聯



35796B
Upper Chain Cutter
35800



35796C
Lower Chain Cutter
35800

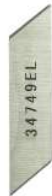

34749EL
Knife
MFC-7605U-H21



钮门刀

BUTTOM HOLE KNIFE

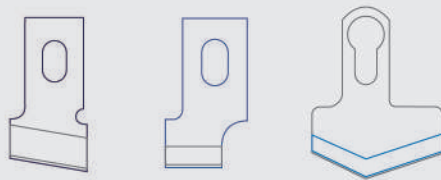



BUTTONHOLE KNIVES for SINGER, JUKI, REECE, BROTHER 胜家 重机 利是 兄弟 钮门刀



71CL 1/4
Buttonhole Knife
71 Class



71CL 5/16
Buttonhole Knife
71 Class



71CL 3/8
Buttonhole Knife
71 Class



71CL 7/16
Buttonhole Knife
71 Class



71CL 1/2
Buttonhole Knife
71 Class



71CL 9/16
Buttonhole Knife
71 Class



71CL 5/8
Buttonhole Knife
71 Class



71CL 11/16
Buttonhole Knife
71 Class



71CL 3/4
Buttonhole Knife
71 Class



71CL 7/8
Buttonhole Knife
71 Class



71CL 1
Buttonhole Knife
71 Class

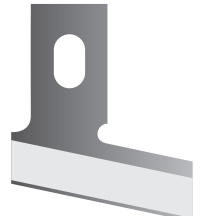

71CL 1 1/8
Buttonhole Knife
71 Class



71CL 1 1/4
Buttonhole Knife
71 Class



71CL 1 3/8
Buttonhole Knife
71 Class



71-90 3/8
Buttonhole Knife
71-90 Class



71-90 7/16
Buttonhole Knife
71-90 Class



71-90 1/2
Buttonhole Knife
71-90 Class



71-90 9/16
Buttonhole Knife
71-90 Class



71-90 5/8
Buttonhole Knife
71-90 Class



71-90 3/4
Buttonhole Knife
71-90 Class



71-90 7/8
Buttonhole Knife
71-90 Class



71-90 1
Buttonhole Knife
71-90 Class



BUTTONHOLE KNIVES for SINGER, JUKI, REECE, BROTHER 胜家 重机 利是 兄弟 钮门刀



S356N 1/8
Buttonhole Knife
S356N Class



S356N 1/4
Buttonhole Knife
S356N Class



S356N 5/16
Buttonhole Knife
S356N Class



S356N 3/8
Buttonhole Knife
S356N Class



S356N 7/16
Buttonhole Knife
S356N Class



S356N 1/2
Buttonhole Knife
S356N Class



S356N 9/16
Buttonhole Knife
S356N Class



S356N 5/8
Buttonhole Knife
S356N Class



S356N 11/16
Buttonhole Knife
S356N Class



S356N 3/4
Buttonhole Knife
S356N Class



S356N 7/8
Buttonhole Knife
S356N Class



S356N 1
Buttonhole Knife
S356N Class



S356N 1 1/8
Buttonhole Knife
S356N Class



S356N 1 1/4
Buttonhole Knife
S356N Class



S356N 1 3/8
Buttonhole Knife
S356N Class



10-3072-0-014
Knife W
Regular Eye 101



10-3072-0-024
Knife W
Regular Eye 101



17-0064-5-864(CA)
Cutting Knife W
Regular Eye 100



C72 11/4RJ-RE
Knife W
Regular Eye 101



BUTTONHOLE KNIVES & NEEDLE PLATE for BROTHER 兄弟 钮门刀



S10570-001 1/8
Needle Plate
1/8" B777



S10572-001 3/16
Needle Plate
3/16" B777



S10573-001 1/4
Needle Plate
1/4" B777



S10605-001
Counter Knife
B777

BUTTONHOLE KNIVES & NEEDLE PLATE for JUKI 重机 钮门刀



B1190-522-SOO
Needle Plate
1/8" DLM-522



B1190-522-TOO
Needle Plate
3/16" DLM-522



B1190-522-UOO
Needle Plate
1/4" DLM-522



B1190-522-VOO
Needle Plate
3/8" DLM-522



B1190-522-XOO
Needle Plate
3/32" DLM-522



B1190-522-YOB
Needle Plate
DLM-522



B4121-052-AOO
Counter Knife
DMN-522



B4121-522-000
Counter Knife
DMN-522



B4121-522-000-L
Counter Knife
DMN-522



B4145-530-BOO
Counter Knife
DMN-530



包边
BINDER

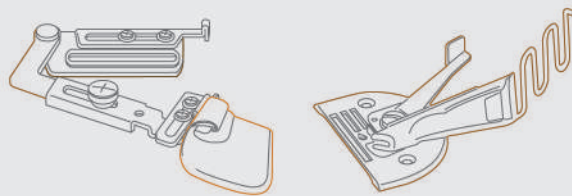



BINDERS & HEMMER FEET for UNION-SP 35800 于仁埋夹筒
23420Z-9 for UNION-SP 35800 MACHINES



23420Z-9 1/8MH
23420Z-9 1/8H
23420Z-9 1/8XH

Double Lap Seam Folder

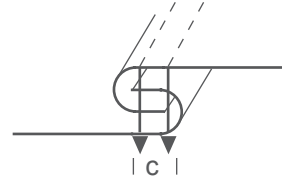

A4 / 100 for SINGLE NEEDLE LOCKSTITCH MACHINES 散口包边筒



Tape Size

3/8"	3/4"
1/2"	7/8"
5/8"	1"

Braid or Tape Binder

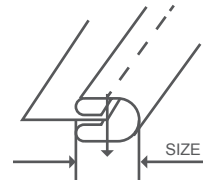

A9 / 508 for SINGLE NEEDLE LOCKSTITCH MACHINES 曲咀包边筒



Tape Size

5/8"	1 1/2"
3/4"	1 5/8"
7/8"	1 3/4"
1"	1 7/8"
1 1/8"	2"
1 1/4"	

Plain Bias Binder

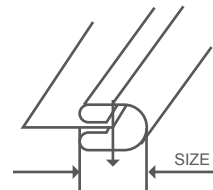

A10 / S60 for SINGLE NEEDLE LOCKSTITCH MACHINES 平车直角包边器



Tape Size

5/8"	16mm	1 1/4"	32mm
11/16"	18mm	1 3/8"	34mm
13/16"	20mm	1 7/16"	36mm
7/8"	22mm	1 1/2"	38mm
15/16"	24mm	1 9/16"	40mm
1"	26mm	1 3/4"	45mm
1 1/8"	28mm	2"	50mm
13/16"	30mm		

Right Angle Bias Binder

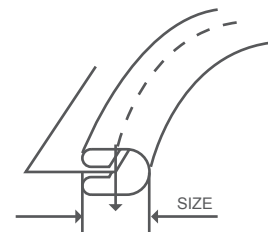



A11 / S72L for SINGLE NEEDLE LOCKSTITCH MACHINES 拉脚筒



Tape Size

1/8"	3mm	13/16"	20mm
3/16"	5mm	7/8"	22mm
1/4"	6mm	1"	25mm
5/16"	8mm	1 1/8"	28mm
3/8"	10mm	1 3/16"	30mm
1/2"	13mm	1 1/4"	32mm
19/32"	15mm	1 3/8"	35mm
5/8"	16mm	1 9/16"	40mm
11/16"	18mm	1 3/4"	45mm
3/4"	19mm	2"	50mm

Sewing Hemmer

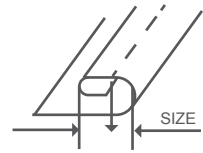

A30 / 121586 for FEED OFF ARM MACHINES 衣袖接缝器



Tape Size

1/4H	3/16H
1/4M	3/16M
1/4MH	3/16MH
1/4XH	3/16XH
1/4XL	

Lap Seam Folder

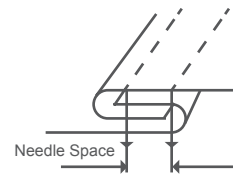

A70 / S70 for FEED OFF ARM MACHINES



Tape Size

1/16"	1/4"
1/8"	3/8"
3/16"	1/2"

Shirts Tail Spring Hemmer

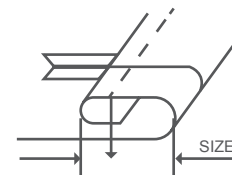

A75D / S75D for SINGLE NEEDLE LOCKSTITCH MACHINES 反下散口拉脚筒



Tape Size

1/2"
1/4"
3/8"

Single Downturn Hemmer

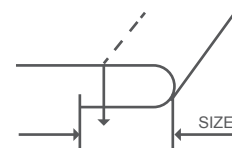



A75U / S75U for SINGLE NEEDLE LOCKSTITCH MACHINES 反上散口拉脚筒



Single Upturn Hemmer

Tape Size

- 1/2"
- 1/4"
- 3/8"

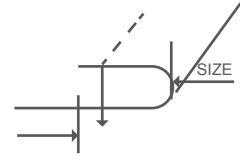

A400 / S400 for SINGLE NEEDLE LOCKSTITCH MACHINES



Plain Hemmer

Tape Size

- | | |
|-------|------|
| 1/16" | 1/4" |
| 1/8" | 3/8" |
| 3/16" | 1/2" |

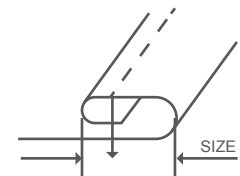

A450 / S450 for SINGLE NEEDLE LOCKSTITCH MACHINES



Spring Hemmer

Tape Size

- 1/16"
- 1/8"
- 1/4"
- 3/16"

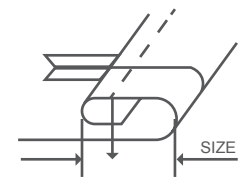

SW75D for SINGLE NEEDLE LOCKSTITCH MACHINES



Single Downturn Hemmer

Tape Size

- 1/2"
- 1/4"
- 3/8"

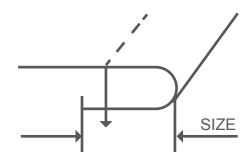



S123 / K710NA for COVERSTITCH MACHINES

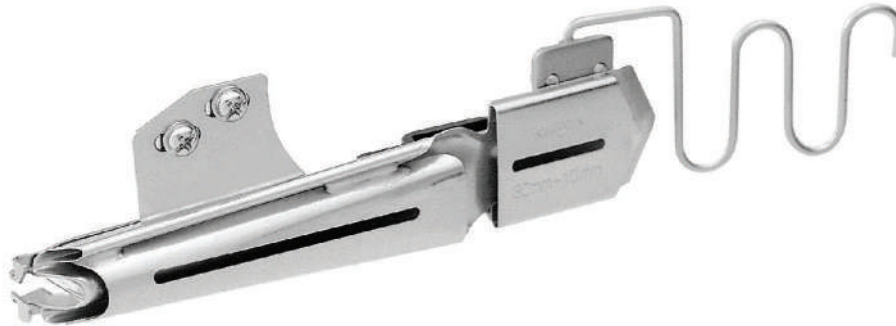

Right Angle Bias Binder-A Type

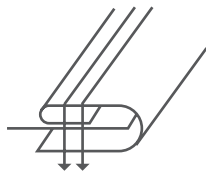

<u>Tape Size</u>		<u>Finished Size</u>	
13/16"	20mm	1/4"	6mm
1"	25mm	5/16"	8mm
1 3/16"	30mm	3/8"	10mm
1 1/4"	32mm	7/16"	12mm
1 3/8"	35mm	1/2"	13mm
1 1/2"	38mm	9/16"	14mm
1 9/16"	40mm	19/32"	15mm
1 9/16"	40mm	5/8"	16mm
1 5/8"	42mm	11/16"	17mm
1 3/4"	45mm	11/16"	18mm
1 7/8"	48mm	3/4"	19mm
2"	50mm	13/16"	20mm
2 3/16"	55mm	7/8"	22mm
2 3/8"	60mm	1"	25mm
2 9/16"	65mm	1 1/8"	28mm
2 3/4"	70mm	1 3/16"	30mm
3"	75mm	1 1/4"	32mm
3"	75mm	1 5/16"	34mm

Right Angle Bias Binder-B Type

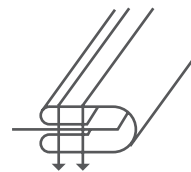

<u>Tape Size</u>		<u>Finished Size</u>	
1"	25mm	1/4"	6mm
1 3/16"	30mm	5/16"	8mm
1 3/8"	35mm	3/8"	10mm
1 9/16"	40mm	7/16"	12mm
1 9/16"	40mm	1/2"	13mm
1 3/4"	45mm	9/16"	14mm
2"	50mm	5/8"	16mm
2 3/16"	55mm	11/16"	18mm
2 3/8"	60mm	13/16"	20mm
2 9/16"	65mm	7/8"	22mm
2 3/4"	70mm	1"	25mm
3"	75mm	1 1/8"	28mm
1 3/16"	80mm	1 3/16"	30mm
3 3/8"	85mm	1 5/16"	34mm



S124 / K712NA for COVERSTITCH MACHINES



Right Angle Bias Binder-A Type

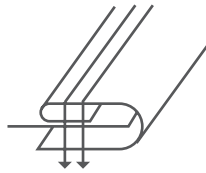

Tape Size		Finished Size	
13/16"	20mm	1/4"	6mm
1"	25mm	5/16"	8mm
1 3/16"	30mm	3/8"	10mm
1 1/4"	32mm	7/16"	12mm
1 3/8"	35mm	1/2"	13mm
1 1/2"	38mm	9/16"	14mm
1 9/16"	40mm	19/32"	15mm
1 9/16"	40mm	5/8"	16mm
1 5/8"	42mm	11/16"	17mm
1 3/4"	45mm	11/16"	18mm
1 7/8"	48mm	3/4"	19mm
2"	50mm	13/16"	20mm
2 3/16"	55mm	7/8"	22mm
2 3/8"	60mm	1"	25mm
2 9/16"	65mm	1 1/8"	28mm
2 3/4"	70mm	1 3/16"	30mm
3"	75mm	1 1/4"	32mm
3"	75mm	1 5/16"	34mm

Right Angle Bias Binder-B Type

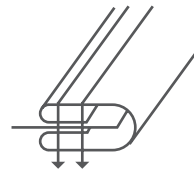

Tape Size		Finished Size	
1"	25mm	1/4"	6mm
1 3/16"	30mm	5/16"	8mm
1 3/8"	35mm	3/8"	10mm
1 9/16"	40mm	7/16"	12mm
1 9/16"	40mm	1/2"	13mm
1 3/4"	45mm	9/16"	14mm
2"	50mm	5/8"	16mm
2 3/16"	55mm	11/16"	18mm
2 3/8"	60mm	13/16"	20mm
2 9/16"	65mm	7/8"	22mm
2 3/4"	70mm	1"	25mm
3"	75mm	1 1/8"	28mm



SW75U for SINGLE NEEDLE LOCKSTITCH MACHINES



Single Upturn Hemmer

Tape Size

- 1/2"
- 1/4"
- 3/8"

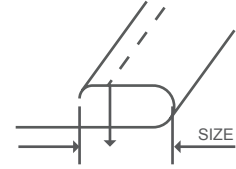

WB301 for WAIST BAND FOLDER 裤头筒



Thickness Standard:H/XH

Finished Sizes a

- a:1" IN:2 3/4"
- a:1 IN:3"
- a:3/16" IN:3 1/8"
- a:1 1/4" IN:3 1/4"
- a:1 3/8" IN:3 1/2"

Folded Size b:3/8"

- a:1 1/2" IN:3 3/4"
- a:1 5/8" IN:4"
- a:1 3/4" IN:4 1/4"
- a:1 7/8" IN:4 1/2"
- a:2" IN:4 3/4"

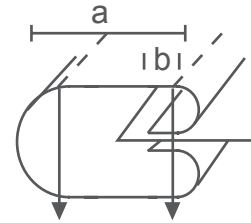

WB302 for WAIST BAND FOLDER with LINIG 落朴裤头筒



Thickness Standard:H/XH

Finished Sizes a

- a:1" IN:2 3/4"
- a:1 1/2" IN:3"
- a:1 3/16" IN:3 1/8"
- a:1 1/4" IN:3 1/4"
- a:1 3/8" IN:3 1/2"

Folded Size b:3/8"

- a:1 1/2" IN:3 3/4"
- a:1 5/8" IN:4"
- a:1 3/4" IN:4 1/4"
- a:1 7/8" IN:4 1/2"
- a:2" IN:4 3/4"

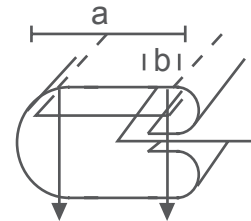

WB307 for TWO PIECES WAIST BAND FOLDER 上下布裤头筒



Thickness Standard:H/XH

Finished Sizes a

- a:1" IN:1 3/4"
- a:1 1/8" IN:1 7/8"
- a:1 3/16" IN:1 15/16"
- a:1 1/4" IN:2"
- a:1 3/8" IN:2 1/8"

Folded Size b:3/8"

- a:1 1/2" IN:2 1/4"
- a:1 5/8" IN:2 3/8"
- a:1 3/4" IN:2 1/2"
- a:1 7/8" IN:2 5/8"
- a:2" IN:2 3/4"

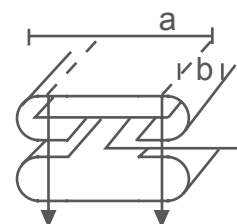



WB308 for TWO PIECES CURVE WAIST BAND FOLDER



Thickness Standard:H/XH

Finished Sizes a

a:1 1/4" IN:2 1/4"
a:1 3/8" IN:2 3/8"
a:1 1/2" IN:2 1/2"

Folded Size b:1/2"

a:1 5/8" IN:2 5/8"
a:1 3/4" IN:2 3/4"

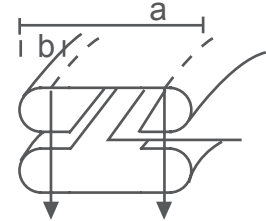

WB309 for TWO PIECES WAIST BAND FOLDER 上下布裤头筒 - 散底



Thickness Standard:H/XH

Finished Sizes a

a:1" IN:1 3/4"
a:1 1/8" IN:1 7/8"
a:1 3/16" IN:1 15/16"
a:1 1/4" IN:2"
a:1 3/8" IN:2 1/8"

Folded Size b:3/8"

a:1 1/2" IN:2 1/4"
a:1 5/8" IN:2 3/8"
a:1 3/4" IN:2 1/2"
a:1 7/8" IN:2 5/8"
a:2" IN:2 3/4"

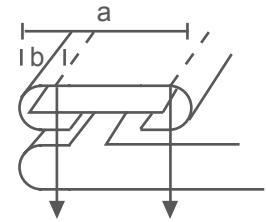

WB313 for BOTTOM WAIST BAND FOLDER 贴底包橡根裤头



Thickness Standard:H/XH

Finished Sizes a

* a:1" IN:1 3/4"
* a:1 1/8" IN:1 7/8"
* a:1 3/16" IN:1 15/16"
a:1 1/4" IN:2 1/4"
a:1 3/8" IN:2 3/8"
***b:3/8"**

Folded Size b:1/2"

a:1 1/2" IN:2 1/2"
a:1 5/8" IN:2 5/8"
a:1 3/4" IN:2 3/4"
a:1 7/8" IN:2 7/8"
a:2" IN:3"

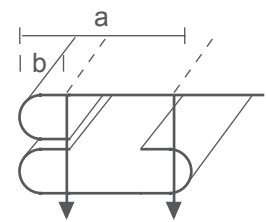

CP201 Top Center Plait Folder 恤衫明筒



Thickness Standard:S/M

Finished Sizes a

* a:7/8" IN:1 5/8"
* a:1" IN:1 3/4"
* a:1 1/8" IN:1 7/8"
a:1 3/16" IN:2 3/16"
a:1 1/4" IN:2 1/4"

Folded Size b:1/2"

a:1 3/8" IN:2 3/8"
a:1 1/2" IN:2 1/2"
a:1 5/8" IN:2 5/8"
a:1 3/4" IN:2 3/4"

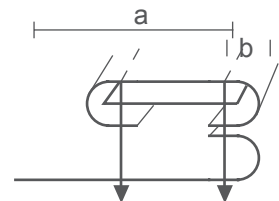

***b:3/8"**



CP203 Top Center Plait Hemmer 恤衫拉筒

Thickness Standard:S/M



Finished Sizes a

a:7/8" c:1/2~3/4"
a:1" c:1/2~7/8"
a:1 1/8" c:5/8~1"
a:1 3/16" c:11/16~1 1/16"
a:1 1/4" c:3/4~1 1/8"

Folded Size b:1/2"

a:1 3/8" c:7/8~1 1/4"
a:1 1/2" c:1~1 3/8"
a:1 5/8" c:1 1/8~1 1/2"
a:1 3/4" c:1 1/4~1 5/8"

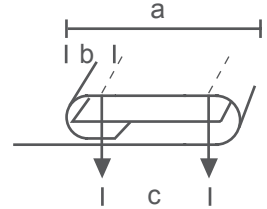

CP204 Imitation Folder 假反筒

Thickness Standard:S/M



Finished Sizes a

a:1" b:1/4" c:5/8"
a:1" b:5/16" c:1/2"
a:1 1/8" b:1/4" c:3/4"
a:1 1/8" b:5/16" c:5/8"
a:1 3/16" b:1/4" c:13/16"
a:1 3/16" b:5/16" c:11/16"
a:1 1/4" b:1/4" c:7/8"

Folded Size b:1/2"

a:1 1/4" b:5/16" c:3/4"
a:1 3/8" b:1/4" c:1"
a:1 3/8" b:5/16" c:7/8"
a:1 1/2" b:1/4" c:1 1/8"
a:1 1/2" b:5/16" c:1"
a:1 5/8" b:1/4" c:1 1/4"
a:1 5/8" b:5/16" c:1 1/8"

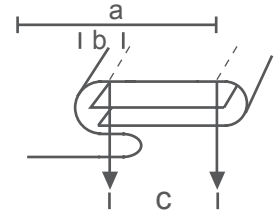

BP206 Plait Folder 拉钮子筒

Thickness Standard:S/M



Finished Sizes a

a:7/8" b:13/16"
a:1" b:15/16"
a:1 1/8" b:1 1/16"
a:1 3/16" b:1 1/8"

Folded Size b

a:1 1/4" IN:1 3/16"
a:1 3/8" IN:1 5/16"
a:1 1/2" IN:1 7/16"

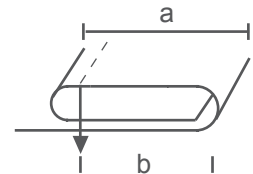

BP207 Plait Folder with Interlining 拉钮子筒有朴

Thickness Standard:S/M



Finished Sizes a

a:3/4"
a:7/8"
a:1"
a:1 1/8"

Folded Size b:3/8"

a:1 3/16"
a:1 1/4"
a:1 3/8"
a:1 1/2"

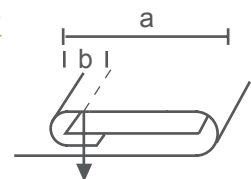



EB531 Edge Binder 捆边蝴蝶 (散口)



Thickness Standard:M

Finished Sizes a

a:3/16"	IN:3/8"
a:1/4"	IN:1/2"
a:5/16"	IN:5/8"
a:3/8"	IN:3/4"
a:1/2"	IN:1"
a:9/16"	IN:1-1/8"

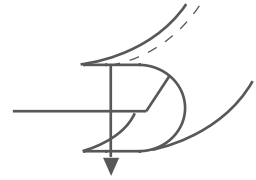

BK213 Single Needle Shirt Yoke Attachment 单针担捍蝴蝶



Thickness Standard:M

Finished Sizes b

b:3/8"

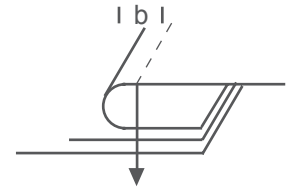

ST211 Single Needle Shoulder Top Stitch Attachment 单针纳膊蝴蝶



Thickness Standard:S/M

Finished Sizes b

b:3/8"

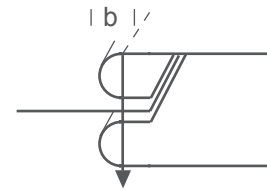

RS219 Sleeve Placket Binder 侧袖筒



Thickness Standard:M/MH

Finished Sizes a

a:1/4"	b:1/4"	IN:1"
a:5/16"	b:1/4"	IN:1 1/8"
a:3/8"	b:1/4"	IN:1 1/4"
a:1/2"	b:1/4"	IN:1 1/2"

Folded Size b:3/8"

a:5/8"	b:3/8"	IN:2"
a:3/4"	b:3/8"	IN:2 1/4"
a:7/8"	b:3/8"	IN:2 1/2"
a:1"	b:3/8"	IN:2 3/4"





CB501 Single up turn folder 散口蝴蝶



Thickness Standard:M

Finished Sizes

3/16"	3/8"	1"
1/4"	1/2"	1 1/4"
5/16"	3/4"	1 1/2"

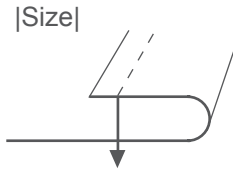

LO516 Belt Loop Folder 耳仔筒



Thickness Standard:M

Finished Sizes: a

a:3/16"	IN:3/4"
a:1/4"	IN:1"
a:5/16"	IN:1 1/4"
a:3/8"	IN:1 3/8"

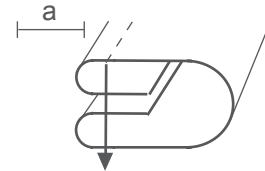

CH502 Swing Hemmer Foot 拉圆脚蝴蝶靴



Thickness Standard:S/M

Finished Sizes

1/8"
3/16"
1/4"

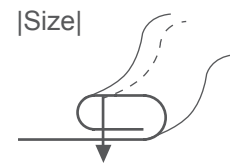

CP527 Suspend Waist Band Attachment 褲腰吊筒蝴蝶



a	c	Bias Tape Size
3/8"	1/4"	7/8"
1/2"	3/8"	1 1/8"
5/8"	1/2"	1 3/8"
3/4"	5/8"	1 1/2"
7/8"	3/4"	1 5/8"
1"	7/8"	1 3/4"
1 1/8"	1"	1 7/8"

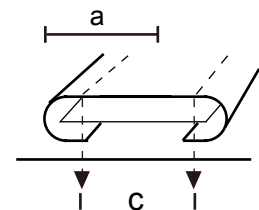



LO515 Loop Folder 耳仔筒靴



Thickness Standard:M

Finished Sizes: a

- a:1/8" IN:1/2"
- a:3/16" IN:3/4"
- a:1/4" IN:1"

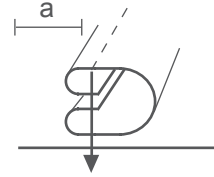

LO535 Spaghetti Attachment 暗线耳仔筒

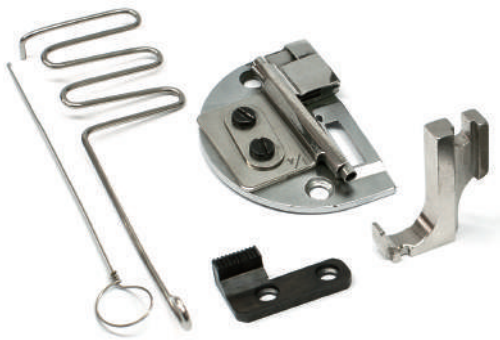

Thickness Standard:S/M

Finished Sizes: a

- a:1/8" IN:5/8" a:5/16" IN:1 1/4"
- a:3/16" IN:7/8" a:3/8" IN:1 3/8"
- a:1/4" IN:1" a:1/2" IN:1 3/4"

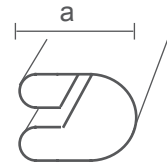

CH503 Short Tail Swing Hemmer 拉圓腳蝴蝶



Thickness Standard:S/M

Finished Sizes: a

- 1/8"
- 3/16"
- 1/4"
- 5/16"

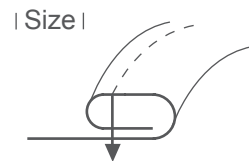

BL339 Belt Loop Folder 耳仔筒



c Tape Size

Finished Size

- | | |
|------|------|
| 15mm | 6mm |
| 18mm | 7mm |
| 20mm | 8mm |
| 22mm | 9mm |
| 24mm | 10mm |
| 26mm | 11mm |
| 30mm | 13mm |
| 34mm | 15mm |
| 38mm | 18mm |
| 45mm | 20mm |

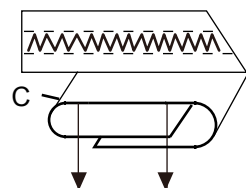



BL340 Belt Loop Folder 耳仔筒



Thickness Standard:H/XH

Finished Sizes: a

a:3/8"	IN:7/8"
a:1/2"	IN:1 1/8"
a:5/8"	IN:1 3/8"

Needle Space c:1/4"

a:3/4"	IN:1 5/8"
a:7/8"	IN:1 7/8"
a:1"	IN:2 1/8"

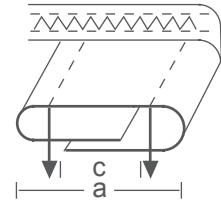

BL342 Belt Loop Folder 耳仔筒



Thickness Standard:H/XH

Finished Sizes: a

H:

a:3/8"	IN:7/8"
a:1 1/2"	IN:1 1/8"
a:5/8"	IN:1 3/8"
a:3/4"	IN:1 5/8"

Needle Space c:1/4"

XH:

a:7/8"	IN:1 7/8"
a:1"	IN:2 1/8"
a:3/8"	IN:7/8"
a:1 1/2"	IN:1 1/8"

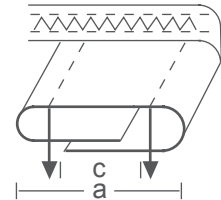

BS333/LS333 Lap seam Folder 上袖蝴蝶



Thickness Standard:H/XH

Finished Sizes a

a:5/16"
a:3/8"

Needle Space c

c:3/16"
c:1/4"

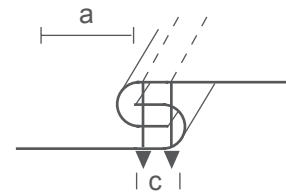

BS334/LS334 Spring type Seam Lap Folder 上袖蝴蝶



Thickness Standard:H/XH

Finished Sizes a

a:5/16"
a:3/8"

Needle Space c

c:3/16"
c:1/4"

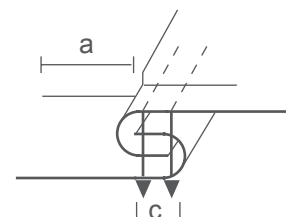



BS337/FA337 Spring type side seam Folder 弹弓阻日字埋夹蝴蝶



Thickness Standard:M/MH/H/XH

Finished Sizes a:7/16"

Needle Space c:9/32"

M:5/16"
MH:3/8"
H:5/16"
XH:3/8"

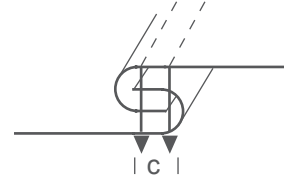

BL340 Belt Loop Folder 耳仔筒



Thickness Standard:H/XH

Finished Sizes a

Needle Space c:1/4"

a:3/8" IN:7/8"
a:1/2" IN:1 1/8"
a:5/8" IN:1 3/8"

a:3/4" IN:1 5/8"
a:7/8" IN:1 7/8"
a:1" IN:2 1/8"

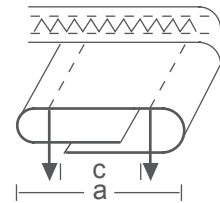



針板

NEEDLE PLATE

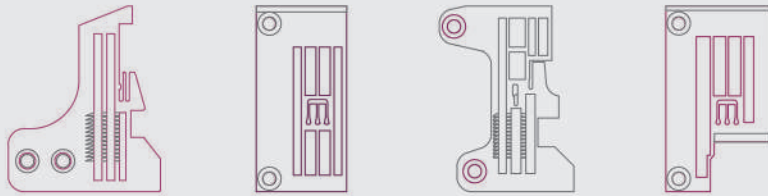



NEEDLE PLATE for OVERLOCK & INTERLOCK SEWING MACHINES - **BROTHER** 兄弟 針板

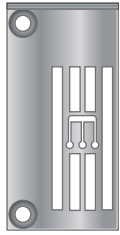

S08723-001
B271-011
B272-011 356

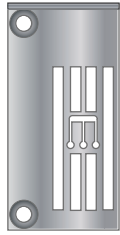

S08724-001
B271-011
B272-011 364

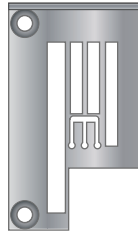

S08731-001
B271-021
B272-021 356

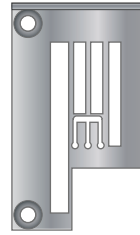

S08732-001
B271-021
B272-021 364

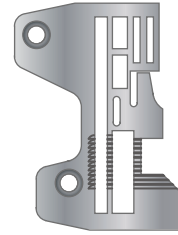

146781-001

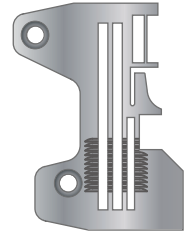

S19145-001

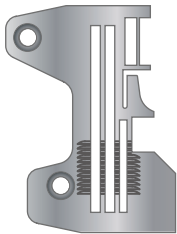

S19146-001
EF4-N11 -01-5 5mm

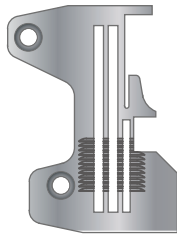

S19154-001
EF4-N11 -01-5(B)
5mm

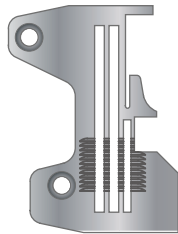

S19155-001
EF4-N11 -01-4(B)
4mm

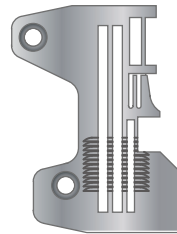

S19162-001
EF4-N21-22-5 2.2x5

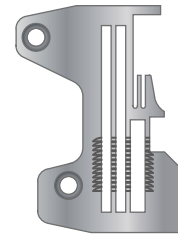

S19166-001
EF4-N21-27-5 2.2x5

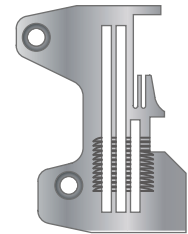

S19169-001
EF4-N21-45-5 2.2x5

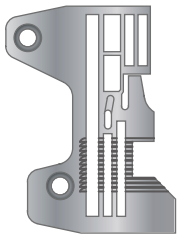

S19185-001
EF4-N31-92-5 5x5

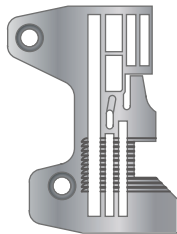

S19186-001
EF4-N31-92-6 5x6

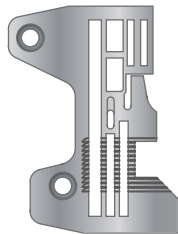

S20232-001
EF4-N31-65-5 5x5

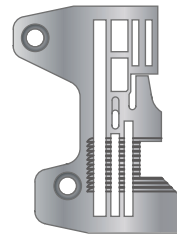

S20234-001
EF4-N31-63-3 3x3

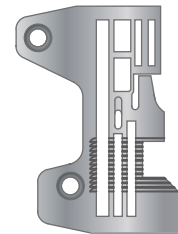

S20236-001
EF4-N31-63-5 3x5

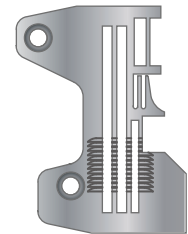

S25190-001
EF4-N21-22-4 2.2x4



NEEDLE PLATE for OVERLOCK & INTERLOCK SEWING MACHINES - **JUKI**

重机 針板

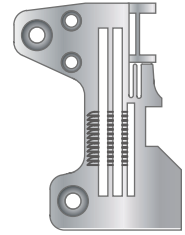
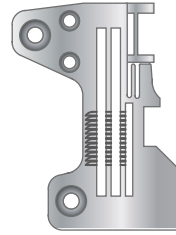
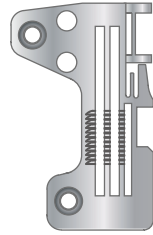
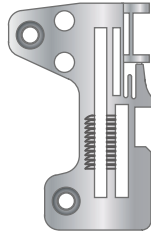
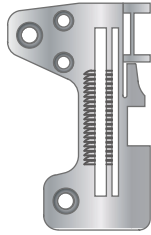
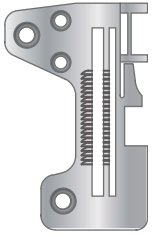

R4200-HOD-D00
MO-2504-OD4-210
3.2

R4200-JOE-D00
MO-3904-OE4 4mm

R4205-HOD-EAO
MO-2514-BD4-200
2x3.2

R4305-HOD-E00
MO-2514-BO6-340
2x3.2

R4305-JOE-E00
MO-3914-BE6 2x4

R4305-J6E-E00

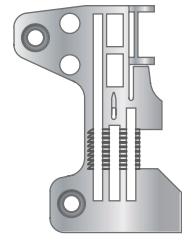
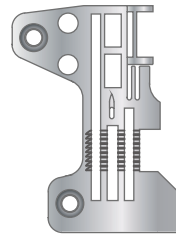
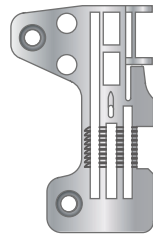
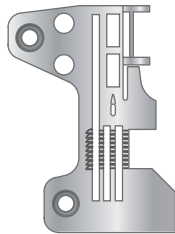
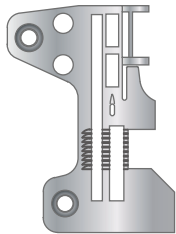
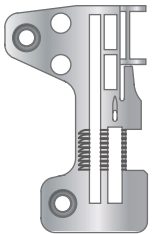

R4508-HOD-D00
MO-2516-DD4-300
3.2x3.2

R4508-JOE-D00
MO-3916-DD4
3.2x4

R4608-JOE-D00
MO-3916-DE6 3.2x4

R4612-HOF-G00
MO-2516-FF6-500
4.8x4.8

R4612-JOD-E01
MO-3943-FBD6
4.8x3.2

R4612-JOF-D00
MO-3916-FF6
4.8x4.8



NEEDLE PLATE for OVERLOCK & INTERLOCK SEWING MACHINES - **KANSAI-SP** 关西 针板

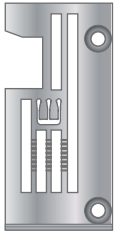

14-7900-0
WX8003EMK 356

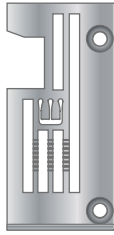

14-7910-0
WX8003EMK 364

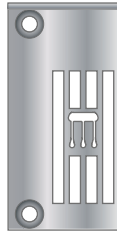

14-8190-0
WX8703D 356

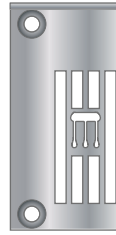

14-8200-0
WX8703D 364

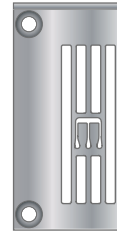

14-8460-0
WX8803C 356

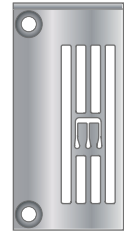

14-8470-0
WX8803C 364

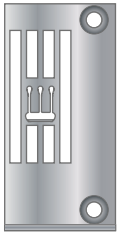

14-8540-0
W8003D W8103D
356

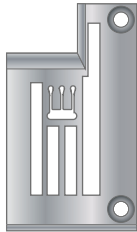

14-8560-0
W8003F 356

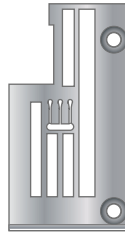

14-8580-0
W8003EMK 356

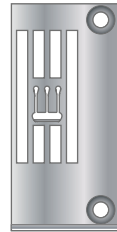

14-8640-0
W8003D W8103D
364

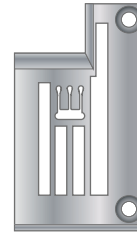

14-8660-0
W8003F 364

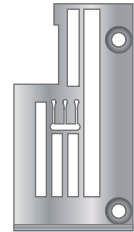

14-8680-0
W8003EMK 364

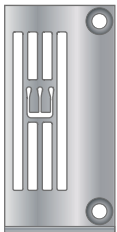

14-8900-0
WX8803D 356

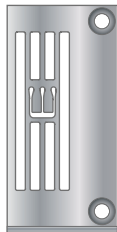

14-8910-0
WX8803D 364



NEEDLE PLATE for OVERLOCK & INTERLOCK SEWING MACHINES - **PEGASUS** 飞马 針板

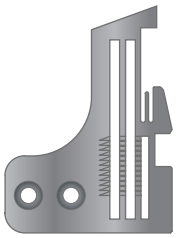

202554E
M852-13 2x4

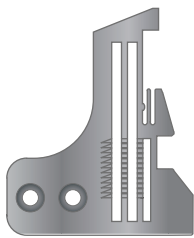

202554E1
M852-13 2x4

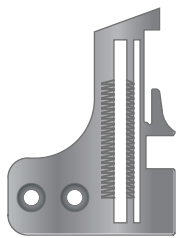

202618A
R53-01/M752-180
4mm

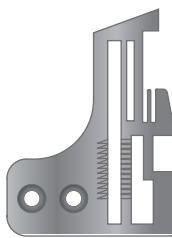

202675
R53-05 2x4

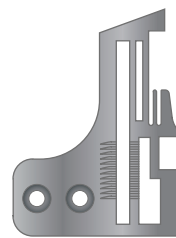

202702
R53-05 2x3

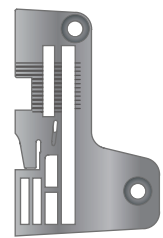

204360A
L32-70 5x5

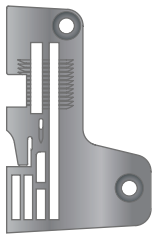

204367
L32-36.38 3X4

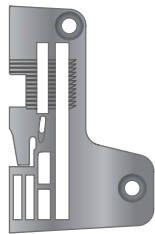

204528
L32--86 5x5

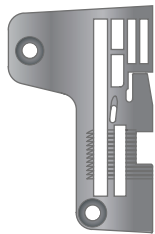

204529
L32--86 5x6

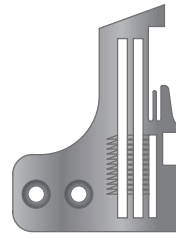

205255
L52/ M752-13 2x3

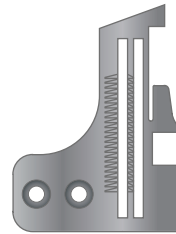

205773
L52/ M752-01 4mm

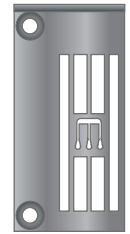

257018B56
W562-01CB 356

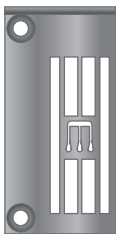

257018B64
W562-01CB 364

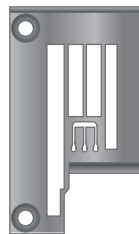

257033B56
W562-02BB 356

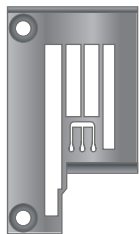

257033B64
W562-02BB 364

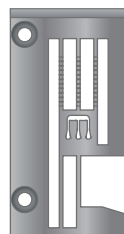

257053B56
W562-05BB 356

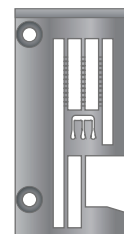

257053B64
W562-05BB 364

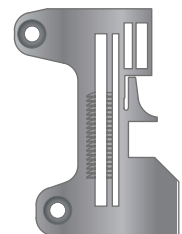

277500P30
EX5204-01/233K
3mm

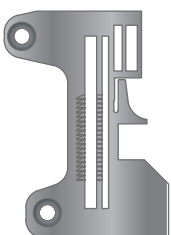

277500P40
EX5204-01/233K
4mm

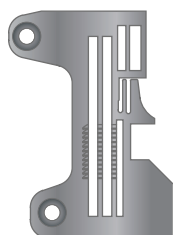

277505R30
EX5212-02/333K
2x3

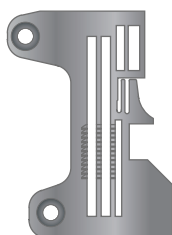

277505R40
EX5212-02/333K
2x4

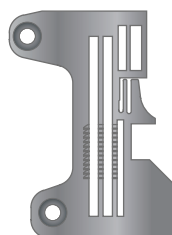

277505R50
EX5212-02/333K
2x5

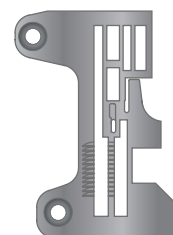

277513R30
EX3216-02/223K
3x3

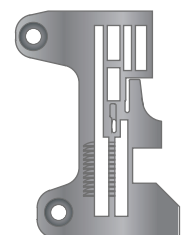

277513R40
EX3216-02/223K
3x4



NEEDLE PLATE for OVERLOCK & INTERLOCK SEWING MACHINES - **PEGASUS**

飞马 针板

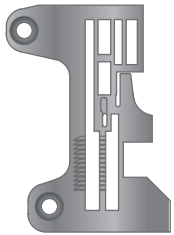

277513R50
EX3216-02/223K
3x5

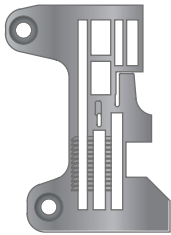

277516R40
EX3216-03/223K
5x6

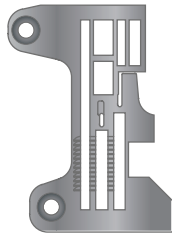

277516R50
EX3216-03/223K
5x5

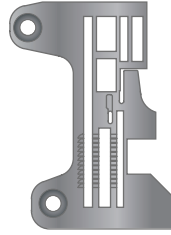

277517R40
EX3216-03/223K
3x4

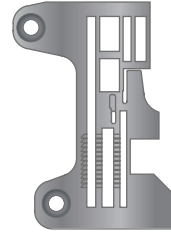

277517R50
EX3216-03/223K
3x5

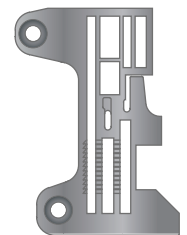

277524T50
EX3216-04/435K
5x5

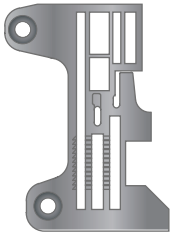

277524T60
EX3216-04/435K
5x6



NEEDLE PLATE for OVERLOCK & INTERLOCK SEWING MACHINES - **SIRUBA** 银箭 针板

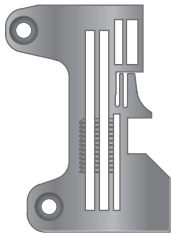

E229

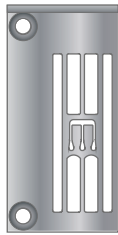

E1826
F007E-W122/UTG
356

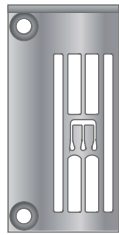

E1827

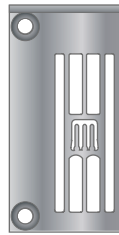

E1828

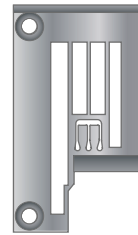

E3326
F007E-W222/FQ
356

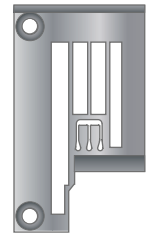

E3327
F007E-W222/FQ
364



E3524P
C007E-W122/CH/
UTP 240



E3826P
C007E-W122/CH/
UTR 356



E3827P
C007E-W122/CH/
UTR 364

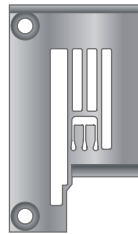

E4426P
C007E-W222/CQ
356

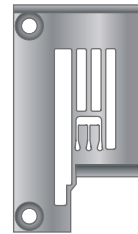

E4427P
C007E-W222/CQ
364

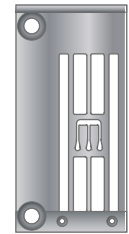

E4826
F007E- W333/FDC
356

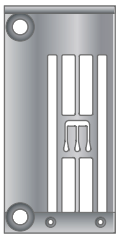

E4827
F007E- W333/FDC
364

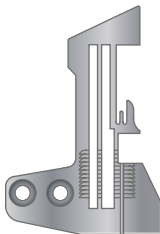

E591B
747F-514M2-23BK-
VT 2x3

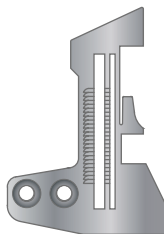

E784
737D-503F1-04
4 mm

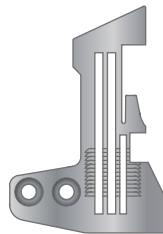

E797
737D-504M3-05
5mm

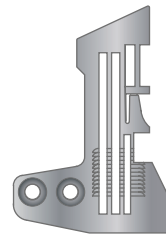

E800
737D-504M2-04
4mm

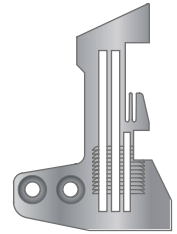

E805
747D-514M4-24 2x4

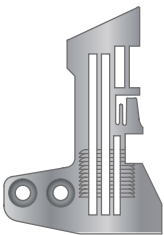

E809
747D-512M1-24 2x4
747D-512M2-25 2x5

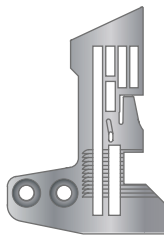
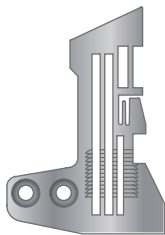

E839
757-516L1-35 3x5

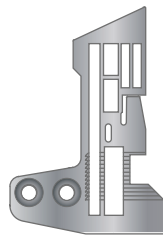

E854
757-516M1-33 3x3

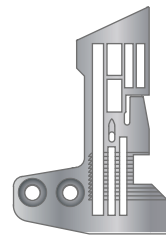

E868
757-516X2-56 5x6t

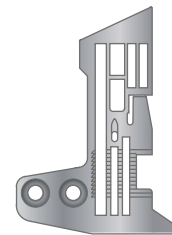

E870
757F-516X2-56 5x6



NEEDLE PLATE for OVERLOCK & INTERLOCK SEWING MACHINES - **SIRUBA** 银箭 針板

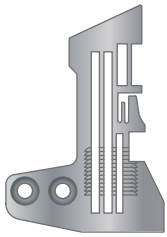

E919

747F-514M2-24 2x4 747F-514M2-25 2x5

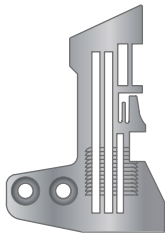

E920

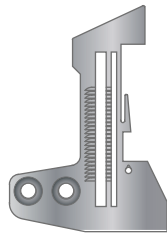

E934

737D-504M1-15
1.5mm

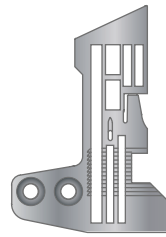

E982

757-516M-35 3x5

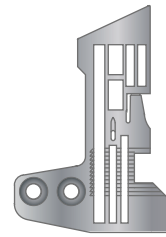

E986

757-516M2-55 5x5

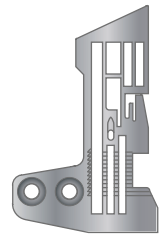

E988

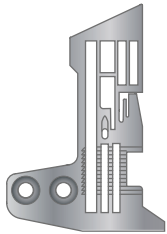

E989



NEEDLE PLATE for OVERLOCK & INTERLOCK SEWING MACHINES - **YAMATO**

大和 針板

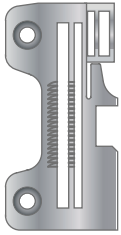

2108000
AZ8000H-04
4mm

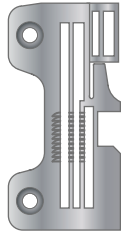

2108003
AZ8003H-04
4mm

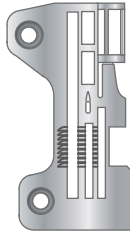

2108052
AZ8502H-C5 5x5

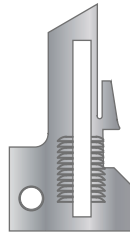

32667
DCZ-200-D2

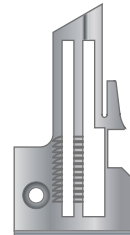

32672
DCZ-203-D2 3.5

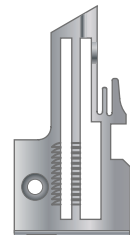

33353
DCZ-220-D1

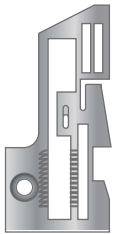

33545
DCZ-361C-D3

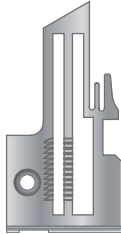

34598
DCZ-520-D1

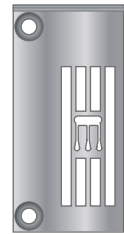

94801
VF-2500 356

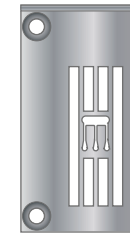

94802
VF-2500 364

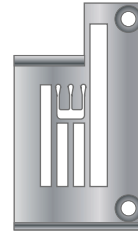

94902
VC-2703 364

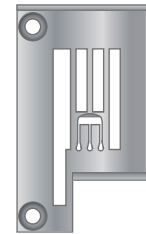

95085
VF-2503 356



3108134

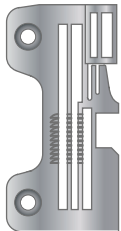

2108004

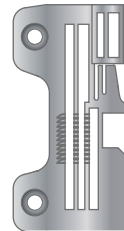

2108005

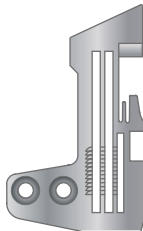

21787
Z5020-Y6



N/P & F/G for SINGLE NEEDLE LOCKSTITCH SEWING MACHINES

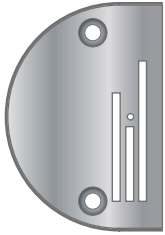

B14
Needle Plate

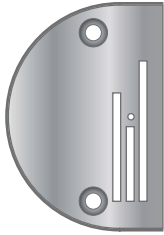

B16
Needle Plate

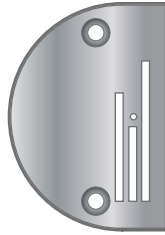

B18
Needle Plate

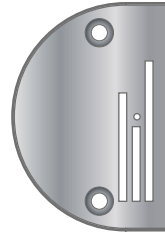

B20
Needle Plate

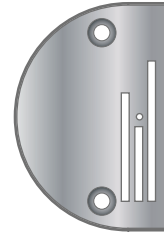

B22
Needle Plate

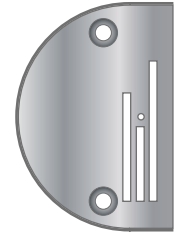

B24
Needle Plate

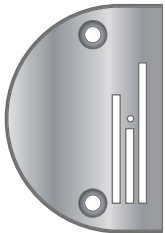

B26
Needle Plate

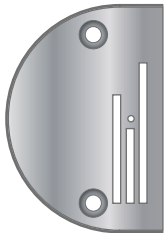

B28
Needle Plate

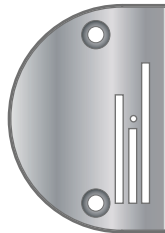

B30
Needle Plate

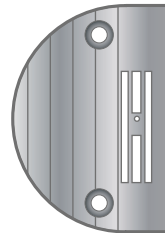

E14
Needle Plate

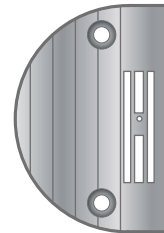

E16
Needle Plate

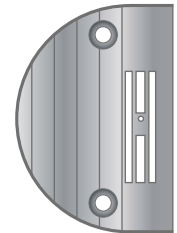

E18
Needle Plate

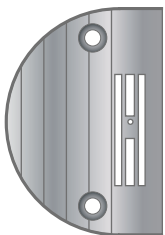

E20
Needle Plate

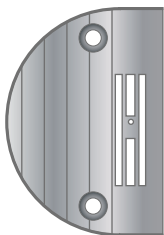

E22
Needle Plate

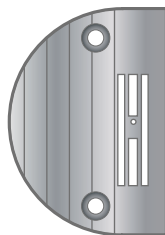

E24
Needle Plate

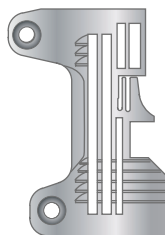

E229
Needle Plate

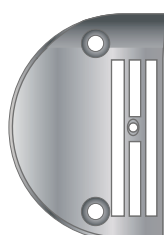

H26
Needle Plate

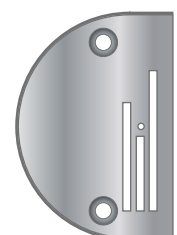

12482
Needle Plate



NEEDLE PLATE for SINGLE NEEDLE LOCKSTITCH SEWING MACHINES

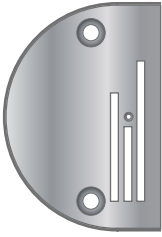

56065
Needle Plate

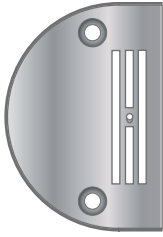

147150LGW
Needle Plate

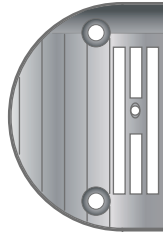

143169W
Needle Plate

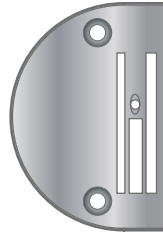

B1109-555-HOB
Needle Plate

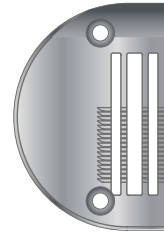

B1109-415-H00
Needle Plate

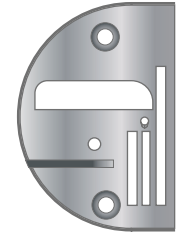

A10-NP NO.1~4
Needle Plate



送布齿 FEED DOG

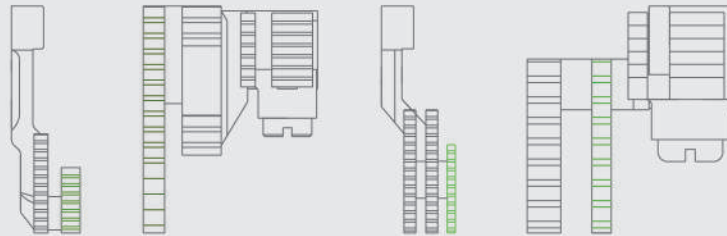



FEED DOG for OVERLOCK & INTERLOCK SEWING MACHINES - **BROTHER** 兄弟 送布齿



S08882-001
B271-011, B272-011



S08883-001
B271-021, B272-021



S19199-001
EF4-N11 -01-4



S19202-001
EF4-N21-27-5



S19212-001
EF4-N11 -01-4(B)



S19217-001
EF4-N21-22-4



S19219-001
EF4-N21-45-5



S19228-101
EF4-N31-92-5



S19236-001
EF4-N11 -01-4



S19237-001
EF4-N21-27-5



S19240-001
EF4-N21-22-4



S19244-001
EF4-N21-45-5



S19247-001
EF4-N31-92-5



S20239-101
EF4-N31-65-5



S20241-101
EF4-N31-63-3



S20245-001
EF4-N31-63-3



146572-001
B551-063



146573-001
B551-065



146574-001
B551-087



146748-001
B511-001



146749-001
B531-022



146567-001+
146577-001
B551-063



146568-001+
146577-001
B551-065



146569-001+
146577-001
B551-087



FEED DOG for OVERLOCK & INTERLOCK SEWING MACHINES - **BROTHER** 兄弟 送布齿



146744-001+
146577-001
B511-001



146744-001+
146577-001
B531-022



2109006+
2109067
AZ8003H-03



2109006+
2109067
AZ8020H-Y5



FEED DOG for OVERLOCK & INTERLOCK SEWING MACHINES - JUKI 重机 送布齿



115-97101+
118-87106
MO-2514-BD4-200



118-82107+
118-87106
MO-2504-OD4-210



118-82404+
118-87106
MO-2514-BO6-340
MO-2414N



118-82800+
118-87403
MO-2516-DD4-300
MO-3916



118-83006+
118-87304
MO-2516-FF6-500



118-85209
MO-2516-DD4-300



118-85407
MO-2516-FF6-500



118-86504
MO-2514-BO6-340
MO-2414N



119-49807+
118-87106
MO-3914-BE6



119-49906
MO-3914-BE6



121-72805
MO-3916-DD4



121-73209
MO-3916-DE6



121-73308
MO-3916-FF6



B1657-804-OOT
MO-2504-OD4-210



B1657-814-BOE
MO-2514-BD4-200
MO-6714



B1657-804-OOT
MO-2504-OA4-150



118-86504
MO-2514-BO6-340
MO-2414N



118-85407
MO-2516-DF6-500



118-86009
MO-2543-FBD6-300



124-78301
MO-3305-OE4-40H/
Z192



B1657-814-BOE
MO-3914-AD4-307



118-82107+
118-87007
MO-2504-OA4-150



118-82404+
118-87106
MO-2514-BO6-340
MO-2414n



118-84004+
118-87403
MO-2543 MO-3916
MO-3943 MO-6716
MO-6743



FEED DOG for OVERLOCK & INTERLOCK SEWING MACHINES - **JUKI** 重机 送布齿



118-84004+

118-87403

124-76305+

124-80307

115-97101+

118-87106

MO-2543-FBD6-300 MO-3305-OE4-40H/Z192 MO-3914-AD4-307



FEED DOG for OVERLOCK & INTERLOCK SEWING MACHINES - **KANSAI-SP** 关西 送布齿



15-7230-0
W8003D W8103D



15-7270-0
W8003F



15-7530-0
W8003D W8103D



15-7560-0
W8003F



15-8070-0
WX8803D



15-808
WX8703D



15-8110-0
WX8003F



15-8120-0
WX8003F



15-8230-0
WX8803C



15-3610-0
DPW-1302S



15-7600-0
B2000C



15-7040-0
B2000



15-805-0
WX8802D



15-3010-0
DPW-1302S



15-8060-0
WX8802D



15-808
WX8803D



15-8440-0
WX8803C



FEED DOG for OVERLOCK & INTERLOCK SEWING MACHINES - PEGASUS 飞马 送布齿



201094B
R53-05



202854A
R53-05



204676-BF



204730A16F
R53-01/M752-180



204730-BF
L52/ M752-01



208063
L32-70



208064
L32--86



208066
L32-36,38



208078-BF



208090A16F
R53-01/M752-180



208090-BF
L52/ M752-01



208215
L32-70



208217
L32--86



208219
L32-36,38



257207-16F
W562-01CB



257216-16F
W562-02BB



257222-16F
W562-05BB



257259-16F
W562-01CB



257262-16F
W562-02BB



257268-16F
W562-05BB



277300-16
EX5204-01/233K



277302-16
EX5204-01/233K



277303-16F
EX5212-02/333K



277305-16
EX5212-02/333K



FEED DOG for OVERLOCK & INTERLOCK SEWING MACHINES - PEGASUS 飞马 送布齿



277323-16
EX3216-02/223K



277325-16
EX3216-02/223K



277327-16
EX3216-03/223K



277329-16
EX3216-03/223K



277330-16
EX3216-03/223K



277337-25
EX3216-04/435K



277339-25
EX3216-04/435K



S08885-001
B271-011,B272-011



S08886-001
B271-021,B272-021



257258-16F
W561-01CB



257261-16F
W561-01CB



257267-16F
W561-03 DB



257289-16F
W664-01CB



257290-16F
W664-01CB



259215-16F
W664-03FB



259203-16F
W664-35BB



204730-BF
L52/ M752-16S1



208219
L32-359 /732-354



208217
L32--34



277305-16
EX5204-02/223K



277329-16
EX3244-03/333K



257206-16F
W561-01CB/W562-01CB



257215-16F
W561-01CB/W562-01CB



257207-16F
W561-03 DB



FEED DOG for OVERLOCK & INTERLOCK SEWING MACHINES - **PEGASUS** 飞马 送布齿



257221-16F
W561-05BB/W562-05BB



257242-16F
W664-01CB



257243-16F
W664-01CB



259103-16F
W664-03FB



259101-16F
W664-35BB



208911
L52/ M752-16S1



208066
L32-359 /732-354



208064
L32--34



277303-16
EX5204-02/223K



277327-16
EX3244-03/333K



FEED DOG for OVERLOCK & INTERLOCK SEWING MACHINES - **SIRUBA** 银箭 送布齿



D1207
F007E-W122



D1216
F007E-W222/FQ



D290
737D-504M1-15



D3216
C007E-W222/CQ



D3217
C007E-W222/CQ



D390
747F-514M2-23BK-VT



D4206
C007E-W122/CH



D4207
C007E-W122/CH



D569
737D-503F1-04



D574
737D-504M3-05



D575
747D-512M1-24



D579
757-516L1-35



D581
757-516M1-33



D582
757-516X2-56



H1259
F007E-W122



H1262
F007E-W222/FQ



H1359
F007E- W333/FDC



H3362
C007E-W222/CQ



H3363
C007E-W222/CQ



H4258
C007E-W122/CH



H4259
C007E-W122/CH



H442
737D-503F1-04



H445
747D-512M1-24



H492
757-516L1-35



FEED DOG for OVERLOCK & INTERLOCK SEWING MACHINES - SIRUBA 银箭 送布齿



H494
757-516M1-33



H497
757-516M-35



H500
757-516M2-55



H501
757-516X2-56



H974
747F-514M2-23BK-
VT



H1258
F007E-W122



H3159
F007E-W122



D1206
F007E-W122
W122/UTG(UTJ)



D1207
C007E-U322/CE



FEED DOG for OVERLOCK & INTERLOCK SEWING MACHINES - YAMATO 大和 送布齿



2109000
AZ8000H-04



2109001+
2109067
AZ8000H-04



2109005
AZ8003H-04



2109006+
2109067
AZ8003H-04



2109055
AZ8502H-C5



2109056+
2109052
AZ8502H-C5



3109000
VC-2700



3109001
VC-2700



3109002
VC-2700



3109003
VC-2700



3109020
VC-2703



3109021
VC-2703



3209000
VF-2500



3209001
VF-2500



3209002
VF-2500



3209003
VF-2500



3209008
VF-2503



3209009
VF-2503



2109007
AZ8003H-03



2109005
AZ8020H-Y5



2109009
AZ8020H-Y6



3159034+
3159019
VE-2713-156S



3159034+
3159012
VE-2713-156L-2-TIN



3209001
VF-2300-156M



FEED DOG for OVERLOCK & INTERLOCK SEWING MACHINES - **YAMATO** 大和 送布齿



3209003
VF-2300-164M



3209001
VF-2400-132M



68096
FD-62G-01MR



3159037
VE-2713-156S



3209000
VF-2300-156M



3209002
VF-2300-164M



3209000
VF-2400-132M



68095
FD-62G-01MR



FEED DOG for SINGLE NEEDLE LOCKSTITCH SEWING MACHINES



12481-22
Feed Dog



12481-19
Feed Dog



12481-17
Feed Dog



12481-15
Feed Dog



12481-13
Feed Dog



12481-11
Feed Dog



12481-9
Feed Dog



272153
Feed Dog



149057
Feed Dog



150793
Feed Dog



99601
Feed Dog



149165
Feed Dog



B1613-555-HOO
Feed Dog



B1609-415-HOB
Feed Dog



B1613-522-NOO
Feed Dog



B1613-522-WOO
Feed Dog



A70 FEED DOG
Feed Dog



2002 FOR A10
Feed Dog



FEED DOG for OVERLOCK & INTERLOCK SEWING MACHINES - **SHING LING** 星菱 送布齿



FE40+FE16
[FW-777-356](#)



FE41
[FW-777-356](#)



压脚

FEET

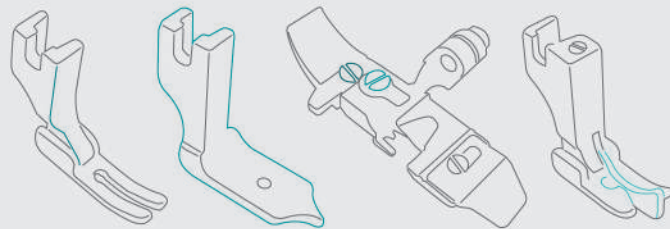



HEMMER FOOT for SINGLE NEEDLE LOCKSTITCH MACHINES

Thin material



NO.1	1/16"(1.6mm)
NO.1 1/2	5/64"(2.0mm)
NO.2	3/32"(2.4mm)
NO.2 1/2	1/8"(3.2mm)
NO.3	5/32"(4.0mm)
NO.4	3/16"(4.8mm)
NO.5	7/32"(5.6mm)
NO.6	1/4"(6.4mm)
NO.7 1/2	5/16"(8.0mm)

Thick material



NO.02	1/8"(3.2mm)
NO.04	3/16"(4.8mm)
NO.06	1/4"(6.4mm)
NO.07	5/16"(8.0mm)
NO.09	3/8"(9.5mm)
NO.095	7/16"(11.1mm)

PRESSER FOOT for OVERLOCK & INTERLOCK SEWING MACHINES



P253E-4(WITH HEAD)
for **SIRUBA**
[747D-512M1-24](#)



P502-A
for **SIRUBA**
[757-516M2-55](#)



S19280-001
for **BROTHER**
[EF4-N21-22-4](#)



S19313-201
for **BROTHER**
[EF4-N31-63-3](#)



S19317-001
for **BROTHER**
[EF4-N31-65-5](#)



S19334-001
for **BROTHER**
[EF4-N31-92-5](#)



208504
for **PEGASUS**
[L32 / M732-38.39](#)



201230C
for **PEGASUS**
[+210374+274018-92B](#)



201230C
for **PEGASUS**
[+210371+274018-92B](#)



201230C
for **PEGASUS**
[+210503+274018-92B](#)



277118
for **PEGASUS**
[EX3216-02/223K](#)



277119
for **PEGASUS**
[EX3216-03/223K](#)



PRESSER FOOT for OVERLOCK & INTERLOCK SEWING MACHINES



277122
for PEGASUS
EX3216-04/435K



257321A56
for PEGASUS
W561-02BB



257331A56
for PEGASUS
W561-05BB

HIRRING FEET 衲折押脚



P952
S952



P950
S950



P5
P5R
2.0mm



P5W
2.8mm

COMPENSATING FEET 高低活动押脚

CR SERIES



CR 1/32E(21R)	1/32" (0.8mm)	CR 1/32	1/32" (0.8mm)
CR 1/16E(211)	1/16" (1.6mm)	CR 1/16	1/16" (1.6mm)
CR 1/8E(212)	1/8" (3.2mm)	CR 1/32NS	1/32" (0.8mm)
CR 3/16E(213)	3/16" (4.8mm)	CR 1/16NS	1/16" (1.6mm)
CR 1/4E(214)	1/4" (6.4mm)	CR 1/32NK	1/32" (0.8mm)
CR 5/16E(215R)	5/16" (8.0mm)	CR 1/16NK	1/16" (1.6mm)
CR 3/8E(216R)	3/8" (9.5mm)		
CR 1/2E(218R)	1/2" (12.7mm)		

CL SERIES



CL 1/32E(22L)	1/32" (0.8mm)	CL 1/32	1/32" (0.8mm)
CL 1/16E(221)	1/16" (1.6mm)	CL 1/16	1/16" (1.6mm)
CR 1/32N(210)	1/32" (0.8mm)	CL 1/32NS	1/32" (0.8mm)
CR 1/16N(211N)	1/16" (1.6mm)	CL 1/16NS	1/16" (1.6mm)
CL 1/32N(220)	1/32" (0.8mm)		
CL 1/16N(221N)	1/16" (1.6mm)		



NR/NL SERIES



NR-31S 1/32" (0.8mm)
NL-31S 1/16" (1.6mm)

211 SERIES



211-13 1/16" x 3/16"
211-14 1/16" x 1/4"
211-15 1/16" x 5/16"
211-16 1/16 x 3/8"
211-18 1/16" x 1/2"

HINGED RAISING FEET 高架活动押脚

P81 L/R(12463HL/R) SERIES



P810(12463HR 1/32)	P810L(12463HL 1/32)	1/32" (0.8mm)
P811(12463HR 1/16)	P811L(12463HL 1/16)	1/16" (1.6mm)
P8115(12463HR 3/32)	P8115L(12463HL 3/32)	3/32" (2.4mm)
P812(12463HR 1/8)	P812L(12463HL 1/8)	1/8" (3.2mm)
P8125(12463HR 5/32)	P8125L(12463HL 5/32)	5/32" (4.0mm)
P813(12463HR 3/16)	P813L(12463HL 3/16)	3/16" (4.8mm)
P814(12463HR 1/4)	P814L(12463HL 1/4)	1/4" (6.4mm)
P815(12463HR 5/16)	P815L(12463HL 5/16)	5/16" (8.0mm)
P816(12463HR 3/8)	P816L(12463HL 3/8)	3/8" (9.5mm)
P818(12463HR 1/2)	P818L(12463HL 1/2)	1/2" (12.7mm)

PIPPING FEET 带沟押脚

P69 L/D(36069L/DG) SERIES



P69L 1/8(36069L 1/8)	1/8" (3.2mm)
P69L 1/4(36069L 1/4)	1/4" (6.4mm)
P69L 3/8(36069L 3/8)	3/8" (9.5mm)
P69L 1/2(36069L 1/2)	1/2" (12.7mm)
P69D 1/8(36069DG 1/8)	1/8" (3.2mm)
P69D 3/16(36069DG 3/16)	3/16" (4.8mm)
P69D 1/4(36069DG 1/4)	1/4" (6.4mm)

HEMMING & FOLDING FEET 滚边及折押脚



S543 6.0 mm
S544 19.0 mm



SPECIAL PIPPING FEET 特殊带沟押脚

P301C/P31C(31358L/12435R) SERIES



P301C 1/8(31358L 1/8)	1/8" (3.2mm)
P301C 3/16(31358L 3/16)	3/16" (4.8mm)
P301C 1/4(31358L 1/4)	1/4" (6.4mm)
P31C 1/8(12435R 1/8)	1/8" (3.2mm)
P31C 3/16(12435R 3/16)	3/16" (4.8mm)
P31C 1/4(12435R 1/4)	1/4" (6.4mm)

HINGED STANDARD FEET WITH GUIDE 针送档边押脚

SP18/SP18L SERIES



SP18 1/32	SP18L 1/32	1/32" (0.8mm)
SP18 1/16	SP18L 1/16	1/16" (1.6mm)
SP18 1/8	SP18L 1/8	1/8" (3.2mm)
SP18 3/16	SP18L 3/16	3/16" (4.8mm)
SP18 1/4	SP18L 1/4	1/4" (6.4mm)
SP18 5/16	SP18L 5/16	5/16" (8.0mm)

QUILTER & GUIDE FEET 绗缝导向押脚



S524



R2E



SPK3

SPECIAL TUBE FEET 特殊管状押脚



A225E
S534
55mm



CORDING FEET 缝端押脚

P3 SERIES



- P36N(12435HN)
- P311N(12435N)
- P31(12435W)
- P301N(31358N)
- P301(31358W)
- P36LN(31358HN)
- P36L(31358HW)
- P36LW(31358HXW)

ZIPPER FEET 拉链押脚



P363
40322SH



P363V
165010H



S518N



S518NS



S518L



P361
121950H



P360
121947H

STANDARD FEET 标准押脚



P58N
142058N



P351
54247



P193
19336



P946
121946



P127
127233



160342



S510



SM20 1/32



150789-001



弯针
LOOPER

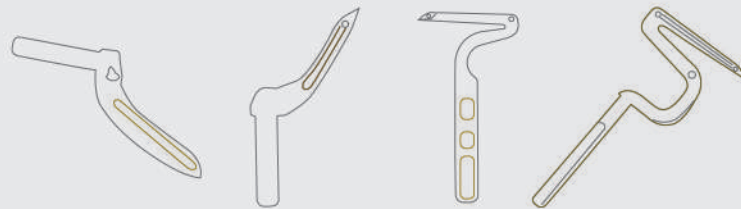



LOOPER for OVERLOCK & INTERLOCK SEWING MACHINES

BROTHER 兄弟 弯针



115069-001
BUTTON SEWER
LOOPER B913



S03536-001
B917



S20626-001
LOWER LOOPER
N11,21,31



19-431
DFB-1404P
DIA.3.15mm



19-431-A
DFB-1404P
DIA.2.5 mm

JUKI 重机 弯针



B1239-372-000
BUTTON SEWER
LOOPER MB-372.3



B2030-380-000
MH-380



B2031-380-000
MH-380



119-99307
LOWER LOOPER
MO-3600,3900

KANSAI-SP 关西 弯针



19-431-N
DFB-1404P DIA.
2.7mm



19-431-S
DFB-1404P DIA.
2.3mm



19-437
RETAINER LOOPER
DFB-1404P

PEGASUS 飞马 弯针



204072
LOWER LOOPER
L32



204949 (11)
UPPER LOOPER
L32



257550
W562



277034
LOWER LOOPER
EX



202408
DCR53-01



202828
M700



LOOPER for OVERLOCK & INTERLOCK SEWING MACHINES

PEGASUS 飞马 弯针



204703
M700

SIRUBA 银箭 弯针



KL25
LOWER LOOPER
737.747.757



KL35A
LOWER LOOPER
737.747.757



LP26
UPPER LOOPER
737.747.757



ME28
F007



MT01
C007

YAMATO 大和 弯针



210930
LOWER LOOPER
AZ8000



310930
VC2600.2700



针钳

NEEDLE CLAMP

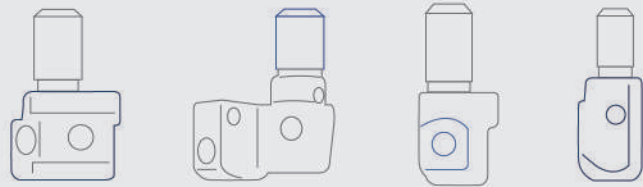



NEEDLE CLAMP for OVERLOCK & INTERLOCK SEWING MACHINES

SIRUBA 银箭 针镙



KG131-E
737D-503F1-04



KG142-E
747D-512M1-24



KG153-E
757-516L1-35



KG155E-E
757-516X2-56



M4240
C007E-W122/CH
W122/CH/UTP/UTR



M4356
F007E-W122
W122/UTG(UTJ)



M4364

PEGASUS 飞马 针镙



208909B92
L32 / M732-38,39



208910
L32 / M732-72,73



209670-92
L52 / M752-01



208905
L52 / M752-13



179630-92
EX5204-01/233K



277022-92
EX5212-02/333K



277027-92
EX3216-02/223K



277028-92
EX3216-03/223K



277029-92
EX3216-04/435K



257518-56
W561-01CB
W562-01CB



257518-64
W561-01CB
W562-01CB



NEEDLE CLAMP for OVERLOCK & INTERLOCK SEWING MACHINES

BROTHER 兄弟 针钳



S20398-001
EF4-N21-22-4



S20404-001
EF4-N31-63-3



S20406-001
EF4-N31-65-5



S21104-001
EF4-N31-92-5



S08711-001
B271-011
B272-011



S08713-001
B271-011
B272-011

JUKI 重机 针钳



118-69005
MO-2504



118-69658
MO-2514-BO6-340
MO-2414N



118-70359
MO-2516-DD4-300



118-70458
MO-2516-FF6-500



121-48607
MO-3904-OE4



121-48706
MO-3914-BE6



121-49803
MO-3916-DD4



121-50306
MO-3916-FF6



121-50603
MO-3943-FBD6



2109100
AZ8003H-04



2109112
AZ8502H-C5

KANSAI-SP 关西 针钳



12-8010-1
W8003D W8103D



12-8020-1
W8003D W8103D



12-8380-0
WX8803D



12-8390-0
WX8803D



NEEDLE CLAMP for OVERLOCK & INTERLOCK SEWING MACHINES

YAMATO 大和 针钳



3209107
VF-2500



3209108
VF-2500



93357
VC-2700



93358
VC-2700



纱剪 剪刀 工具 磨刀石 特殊刀

SCISSORS, THREAD CLIPPERS,
GRINDING STONE, SPECIAL KNIVES

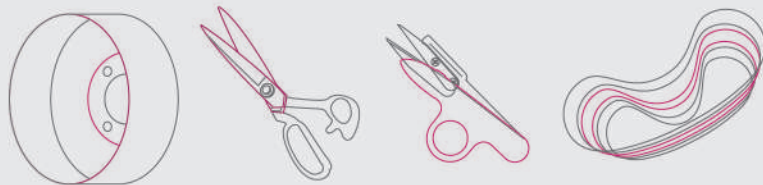



THREAD CLIPPERS TC-100 纱剪



Blade:Steel
Handle:ABS
Weight:14g

- TC-100R(RED)
- TC-100B(BLUE)
- TC-100P(PURPLE)
- TC-100O(ORANGE)
- TC-100T(TURQUOISE)

THREAD CLIPPERS TC-801 纱剪



Blade:Stainless Steel
Handle:ABS
Handle:26g

- TC-801G(GREEN)
- TC-801B(BLUE)
- TC-801Y(YELLOW)
- TC-801O(ORANGE)

THREAD CLIPPERS TC-805B 纱剪



Light weight & Durable
Blade:Steel (Black Oxide Finish)
Handle:PPS
Weight:16g
Color:Matte Black

THREAD CLIPPERS TC-805BS 纱剪



Stainless Steel Blade
Blade:Stainless Steel
Handle:PPS
Weight:16g
Color:Matte Black

THREAD CLIPPERS TC-805 纱剪



Classic Best Seller
Blade:Steel
Handle:Yellow Zinc Plating
Weight:18g
Color:Metallic Gold

RING TYPETHREAD CLIPPERS 指环刀



- TC-RG01Y
- TC-RG02B
- TC-RG02O
- TC-RGMIX



THREAD CLIPPERS TC-808SB 纱剪



Blade:Stainless Steel

Handle:Aluminum

Weight:30g



PROFESSIONAL TAILOR SHEAR 专业裁缝剪刀



TC-P300 12" | TC-P280 11" | TC-P260 10" | TC-P240 9" | TC-P220 8"

GOLDEN EAGLE tailor shears use the best quality German special tool steel and finest soft steel composite through special heat treatment for its durable wear-resistant and its long lasting using.

Handle at the top and bottom are different. The bottom curve is small and the top curve is very large, forming almost a straight line, prevents slipping and dropping out of hand.

Thickness of the cutting edge is the same with front and back, even gaps between the edges, comfortable to hold in hand and smooth to use. GOLDEN EAGLE tailor shears is perfectly designed according to ergonomic, coated with durable plastic material for extra comfort and long-time using, specially designed for professional tailors.

PINKING SHEAR TC-230 花边剪刀





HIGH QUALITY TAILOR SHEAR 高級裁縫剪刀



color: black, silver

GOLDEN EAGLE household tailor shears use the best quality special tool steel and heat treatment for its durable wear-resistant and its long lasting using.

Handle at the top and bottom are different. The bottom curve is small and the top curve is very large, forming almost a straight line, prevents slipping and dropping out of hand.

Thickness of the cutting edge is the same with front and back, even gaps between the edges, comfortable to hold in hand and smooth to use. GOLDEN EAGLE household tailor shear is perfectly designed according to ergonomic, coated with durable plastic material for extra comfort and long-time using.

TC-A300H 12" | TC-A280H 11" | TC-A260H 10" | TC-A240H 9" | TC-A220H 8"

STAINLESS SCISSORS TC-S230 不锈钢剪刀



TAGGING GUN 吊牌枪



- TG-88S-O
- TG-88S-B
- TG-88S-R



SKIVING BELL KNIVES 削皮刀 铲皮刀



LEATHER-GE
SIZE:117X114X52.2

BAND KNIVES 钢带刀 运剪刀



2200X10X0.45	3500X10X0.45	4120X10X0.45
2310X10X0.45	3600X10X0.45	4200X10X0.45
2450X10X0.45	3700X10X0.45	4290X10X0.45
2800X10X0.45	3760X10X0.45	4500X10X0.45
3000X10X0.45	3850X10X0.45	4555X10X0.45
3100X10X0.45	3860X10X0.45	4745X10X0.45
3150X10X0.45	3900X10X0.45	4920X10X0.45
3240X10X0.45	3960X10X0.45	5030X10X0.45
3250X10X0.45	4000X10X0.45	5300X10X0.45
3380X10X0.45	4100X10X0.45	



ABRASIVE BELTS 砂布带



GS-181C2-1
GS-181C2-2
GS-181C2-5
KM EU 100

ROBO GRIP-7 Inch 管钳



The most versatile tools in your tool box

HEX WRENCHES

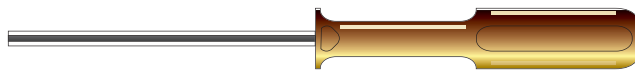

37919



990474-0-10

CLEANING GUN 清洁喷枪

Standard Nozzle



Adjustable Nozzle



CG-500(S)110V
CG-500(S)220V
CG-500(AJ)110V
CG-500(AJ)220V
CG-500(S+AJ)110V
CG-500(S+AJ)220V

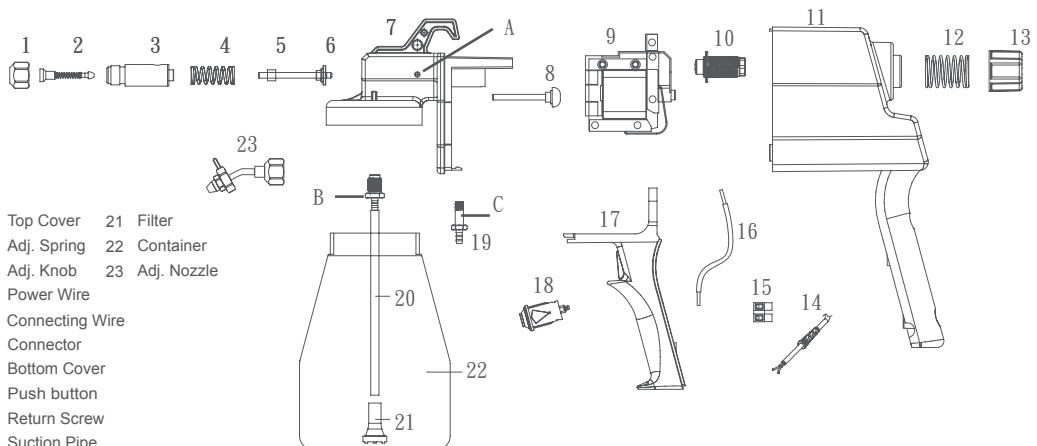

- | | | |
|----------------------|--------------------|----------------|
| 1 Nozzle | 11 Top Cover | 21 Filter |
| 2 Spreading Plug | 12 Adj. Spring | 22 Container |
| 3 Cylinder | 13 Adj. Knob | 23 Adj. Nozzle |
| 4 Compression Spring | 14 Power Wire | |
| 5 Oil Absorber | 15 Connecting Wire | |
| 6 Compression Rod | 16 Connector | |
| 7 Front Cover | 17 Bottom Cover | |
| 8 Pushing Rod | 18 Push button | |
| 9 Coli Set | 19 Return Screw | |
| 10 Adj. Screw | 20 Suction Pipe | |



GRINDING STONE-EASTMAN 伊士曼 磨刀石

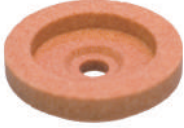

131C1-12
133C1-12



133C1-25



133C1-11



133C1-14

GRINDING STONE-MAIMIN 磨刀石



381A



330N



525

GRINDING STONE-WOLF 磨刀石



12701
12801



12800



45483

GRINDING STONE-SU LEE 磨刀石



2626-S



2626



26327



GRINDING STONE-NIPPY 磨刀石



416



400/7
T-50
7506-2



513
T-80
7506-1

STONE FEED ROLLER

GRINDING STONE-SUPRENA 磨刀石



M688Z

GRINDING STONE-KM 磨刀石



A-118



S150



R-58



R101J103



R101E08



R101W05



裁布机零件

CUTTING MACHINE SPARE PARTS

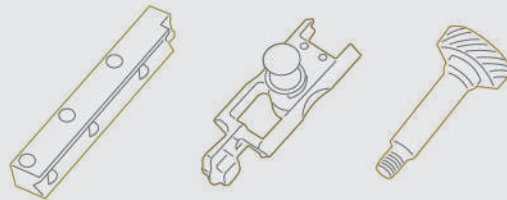



CUTTING MACHINE SPARE PARTS FOR EASTMAN TYPE SERIES

4C1-99	SHARPENER HOLD-DOWN, NUT	磨刀器固定螺母
4C1-150	SHARPENER HOLD-DOWN, NUT	磨刀器固定螺母
4C1-179	FRONT-TO-REAR BRARING, NUT	電機固定螺母
4C2-2	PLATE BOLT, NUT	底盤螺母
20C3-38	FRONT TO REAR BEARING, SCREW	電機螺栓
20C3-39	FRONT TO REAR BEARING, SCREW	電機螺栓
20C13-96	STANDARD-TO-BEARONG, SCREW	電機螺栓
24C4	PLATE, BOLT	電機螺栓
4C1-145	SHAFT, LOCKNUT	鎖軸螺母
4C2-87	CLUTCH ,NUT	離合器螺母
8C5-10	AUTOMATIC STITCH INSULATION	磨刀器固定螺母
8C12-4	LEAD WIRE INSULATION	磨刀器固定螺母
10C1-41	FAN ROTOR	散熱風扇
12C1-12	LOADING SPRING, WASHER	底盤螺母
12C1-32	LOCK, WASHER	外齒墊圈
13C1-9	TUNING KNOB	手動旋鈕
18C6-16	RETAINING RING	電機螺栓
22C1-24	CARRYING HANDLE	提把
30C1-8	DUST CAP	鎖軸螺母
34C1-51	CLUTCH, SPRING	電機後蓋彈簧
47C4-79	TERMINAL	接線端子
47C4-80	TERMINAL	接線端子
53C7-35	FAN COVER	風扇後蓋
73C7-121	TERMINAL WIRE TUBING	護線套管
90C1-146	REAR BEARING HOUSING	電機後罩
90C6-46	REAR BALL BEARING	6201 滾珠軸承
254C1	CABLE TIE 4"	扎帶
300C12-6	SCREW, ROUND HEAD	8-32*1/2 半圓頭螺釘
301C8-1	SCREW, #4-40 X 1/2 FILLISTER HEAD	4-40*1/2 球面圓柱頭螺釘
301C12-3	SCREW, #8-32 X 3/8 FILLISTER HEAD	8-30*3/8 球面圓柱頭螺釘
305C8-1	SCREW,BINDING HEAD	4-40*1/4 卷頭螺釘
305C10-1	SCREW,BINDING HEAD	6-32*1/4 卷頭螺釘
597C2-14	CUTOUT ASSY 60 CYCLE 3600RPM	離心開關
597C2-15	CUTOUT ASSY 50 CYCLE 3000RPM	離心開關
580C1-192	CUTOUT SWITCH SINGLE SPEED	離心開關
783C1-3	GROUNDING WIRE ASS'Y	接地線
4C1-111	OPEARING HANDLE LOCK NUT	手柄螺母
4C1-132	CRANK BELL BEARING LOCK NUT	圓曲柄軸承蓋
4C1-190	LOCK NUT FOR SHAFT	曲柄軸螺母
4C2-91	NUT FOR GUIDE SCREW	導板調整螺母
4C2-110	STOP NUT	電容器止動螺母
4C3-8	GUIDE ADJUSTMENT NUT	導板螺母
11C12-92	SHAFT FOR BALL BEARING	圓曲柄軸
12C1-21	SHAKEPROOF WASHER	內齒彈性墊圈
12C1-24	KNIFE LOCK WASHER	壓力墊片
12C10-2	WASHER	墊圈
12C15-14	GUIDE WASHER	墊圈
12C15-53	CONNECTING ROD WASHER	連桿墊圈
15C13-23	STUD,UPPER	雙頭螺栓
15C13-34	STUD, LOWER L.H. MOUNTING	下左雙頭螺栓
15C13-39	STUD, LOWER R.H. MOUNTING	下右雙頭螺栓
17C4-6	WRIST PIN	腕銷
18C6-79	LOCK RING	油屏螺母
18C6-80	O-RING	油屏墊片
20C5-17	CONNECTING ROD CLAMP SCREW	傳動桿緊固螺絲



CUTTING MACHINE SPARE PARTS FOR EASTMAN TYPE SERIES

20C12-62	FRONT HOUSING PLUG SCREW	螺釘
20C12-79	SCREW FOR HANDLE BRACKET	手柄托架螺絲
24C1-3	KNIFE LOCK BOLT	刀片鎖緊螺絲
34C10-142	SPRING FOR CAPACITOR	電容彈簧片
52C5-235	SWITCH PLATE (SINGLE-SPEED)	下左雙頭螺柱
53C6-2	OILER TUBE COVER	油槽蓋
53C11-91	CAPACITOR COVER	電容器架
54C4-32	WRIST PIN PLUG	腕銷栓
62C1-140	HANDLE BRACKET	把手托架
71C3-18	FRONT BALL BEARING RETAINER	前軸承蓋
73C7-203	OIL TUBE , CLEAR	導油管
73C7-204	OILER TUBE	油槽
85C1-45	CRANK 5 - 1-1/2" STROKE	圓曲柄 1 1/2 沖程
90C6-38	FRONT BALL BEARING	6203 滾珠軸承
91C4-25	RIVET CROSSHEAD	鉚釘
191C1-21	CROSS HEAD FELT PAD	滑座油墊
191C1-38	WRIST PIN FELT PAD	腕銷油芯
191C1-42	OIL FELT WICKING, LONG	長油芯
191C1-43	OIL FELT WICKING, SHORT	短油芯
191C1-45	OIL FELT WICKING .187DIA X .44	主油芯
201C1-11	EYELET	導油管
300C3-2	SCREW	2-56*1/8 半圓頭螺釘
302C8-2	SCREW, FLAT HEAD #4-40 X 3/4	4-40*3/4 沉頭螺釘
302C10-4	SCREW, #6-32 X 5/16 FLAT HEAD	6-32*5/16 沉頭螺釘
307C18-1	SCREW	手柄托架固定螺絲
308C12-1	SCREW, #8-32 X 3/8 SOCKET HEAD	8-32*3/8 內六角螺釘
308C14-1	GUIDE HOLD DOWN SCREW	導板內六角螺釘
309C15-5	GUIDE ADJUSTMENT SCREW	導板調整螺絲
525C1-5	L.H. & R.H. GUIDES 1-1/2 STROKE	1 1/2 沖程導軌
531C1-53	OPERATING HANDLE	手柄組
579C2-17	CROSS HEAD (W/ WRIST,PIN,WASHER,BOLT)	滑座組
580C1-198	SWITCH-SINGLE-SPEED-1&3-PHASE	電源開關
607C1-35	OILING DEVICE	油槽組
664C1-4	CONNECTING ROD 1 1/2 STROKE	連桿組 沖程 1 1/2
706C1-4	CAPACITOR 629 110V	手柄托架固定螺絲
706C1-5	CAPACITOR 629 220V	8-32*3/8 內六角螺釘
4C1-149	NUT, ELASTIC	螺軸止動螺母
4C1-161	NUT, SELF LOCK	鎖托架止動螺母
4C2-112	L.H. NUT FOR SCREW SHAFT	螺軸右旋螺母
4C2-113	R.H. NUT FOR SCREW SHAFT	螺軸左旋螺母
5C5-16	COLLAR, LOWER	螺軸固定墊圈
11C12-54	SHAFT FOR CAM	放鬆桿彈簧銷
12C15-57	SPRING WASHER FOR RELEASE LEVER	放鬆桿彈性墊圈
12C15-69	WASHER FOR LOCK BRACKET	護刀桿墊片
12C15-74	WASHER, FLAT	軸承厚墊片
12C15-91	THRUST WASHER, UPPER NUT	軸承薄墊片
17C15-106	ROLL PIN FOR COLLAR	彈性圓柱銷
20C4-17	PRESSURE FOOT LEVER SCREW	壓腳柄螺絲
20C12-13	CAM SHAFT SPRING SCREW	彈簧螺絲
20C12-113	SCREW FOR LATCH	撥叉螺絲
20C12-117	SCREW FOR PRESSURE FOOT SHOE	壓腳螺絲
20C12-156	SCREW FOR RELEASE LEVER	放鬆桿螺絲
20C12-137	SCREW FOR KNIFE GUARD LOCK	鎖托架螺絲
22C3-2	LIFT HANDLE FOR KNIFE GUARD LOCK	護刀桿把手
34C1-20	TENSION SPRING	蝸旋彈簧



CUTTING MACHINE SPARE PARTS FOR EASTMAN TYPE SERIES

34C8-12	SPRING FOR PRESSURE FOOT LOCK	鎖托架彈簧
34C10-179	SPRING FOR PRESSURE FOOT LEVER	壓腳柄彈簧
34C10-107	SPRING FOR LATCH	撥叉彈簧
53C11-72	COVER FOR CAM	彈簧螺絲
53C11-103	VINYL COVER FOR HANDLE	手柄護套
55C4-49	SPACER FOR KNIFE GUARD LOCK BRACKET	厚薄規
68C1-192	PRESSURE FOOT SHOE, ALL STROKES	壓腳
71C3-15	THRUST BALL BEARING	推力軸承
86C7-34	CAP FOR TUBE	管帽
90C4-47	BEARING FOR CAM SHAFT	中間齒輪含油軸承
97C3-35	LATCH FOR CAM	撥叉
147C1-26	EXTENSION FOR SCREW SHAFT	螺軸延長
171C1-16	LOCK (ONLY) FOR PRESSURE FOOT	壓腳鎖
300C10-1	SCREW, #6-32 X 3/16 ROUND HEAD	6-32*3/16 半圓頭螺釘
300C10-4	SCREW, #6-32 X 3/8 ROUND HEAD	6-32*3/8 半圓頭螺釘
302C10-8	SCREW, #6-32 X 3/4 FLAT HEAD	6-32*3/4 沉頭螺釘
309C15-7	SET SCREW FOR CAM	彈簧鎖緊固定螺絲
553C1-7	PRESSURE FOOT LOCK BRACKET COMPLETE	護刀桿托架組
553C1-8	PRESSURE FOOT LOCK BRACKET ONLY	護刀桿托架
605C1-36	PRESSURE FOOT ROD 7"-8" KNIFE	8" 護刀杆組件
605C1-37	PRESSURE FOOT ROD 9"-10" KNIFE	10" 護刀杆組件
621C1-7	RELEASE LEVER WITH CAM	放鬆桿連凸輪
683C1-17	PREAAURE FOOT LEVER	壓腳手柄組
713C4-4	SCREW SHAFT W/EXTENSION R&H HEAD	5-8" 螺軸組件
713C4-5	NUTS 5-8"(713C-4) / NUTS 9-10"(713C-5)	9-10" 螺軸組件
732C1-11	SHARPENER HOUSING W/BUSHING, TUBES ONLY	磨刀器罩 (連襯和管子) 5-8"
732C1-12	5"- 8" KNIFE(732C1-11) / 9"- 10" KNIFE(732C1-12)	磨刀器罩 (連襯和管子) 9-10"
65C1-77	ROD FOR PRESS FOOT 5"-8"	8" 護刀杆
65C1-75	ROD FOR PRESS FOOT 9"&10"	10" 護刀杆
11C12-95	SCREW SHAFT ONLY 5" - 8"	5-8" 螺軸
11C12-96	SCREW SHAFT ONLY 9" -10"	9-10" 螺軸
4C2-85	R.H. FOLLOWER NUT	右方軸螺母
4C2-86	L.H. FOLLOWER NUT	左方軸螺母
11C12-58	R.H. SQUARE SHAFT 5"-8" KNIFE	右方軸 8"
11C12-59	R.H. SQUARE SHAFT 9"-10" KNIFE	右方軸 10"
11C12-56	L.H. SQUARE SHAFT 5"-8" KNIFE	左方軸 8"
11C12-57	L.H. SQUARE SHAFT 9"-10" KNIFE	左方軸 10"
11C12-64	SHAFT FOR CRANK	曲柄軸
12C11-74	THRUST WASHER	耐磨墊片
12C15-29	THRUST WASHER	斜齒輪墊片
12C15-30	THRUST WASHER FOR BOTTOM PLATE	半圓墊片
17C15-78	PIN FOR BELL CRANK	曲柄銷
17C15-103	ROLL PIN FOR PUSH ROD	推杆彈性圓柱銷
17C15-113	SPREADER PIN	推展銷
18C6-81	RETAINING RING FOR SHAFT	曲柄軸卡簧
18C6-26	RETAINING RING FOR BELL CRANK	曲柄卡簧
34C10-89	SPRING FOR BELL CRANK	曲柄彈簧
55C4-41	SPACER BELL CRANK	曲柄軸承襯套
62C16-151	SHARPENER HOUSING (ONLY)	耐磨墊片
65C6-75	PUSH ROD	推杆
71C1-10	OIL RETAINER-IDLER GEAR	貯油器
73C7-46	TUBE FOR SQUARE SHAFT 5"-8' KNIFE	8" 方軸管
73C7-47	TUBE FOR SQUARE SHAFT 9"-10" KNIFE	10" 方軸管
73C7-48	TUBE FOR SCREW SHAFT 5"-8" KNIFE	8" 螺軸管



CUTTING MACHINE SPARE PARTS FOR EASTMAN TYPE SERIES

73C7-49	TUBE FOR SCREW SHAFT 9"-10" KNIFE	10" 螺軸管
79C12-163	BOTTOM PLATE, SHARPENER HOUSING	磨刀器底盤
85C3-6	CRANK BELL (ONLY)	曲柄
87C3-8	SPIRAL GEAR	螺旋齒輪
87C3-44	SPUR GEAR	磨刀器底盤齒輪
87C3-53	GEAR AND SHAFT	曲柄傳動齒輪軸
90C4-29	BEARING FOR DRIVE SHAFT (LOWER)	傳動含油軸承
90C4-33	BEARING FOR GEAR	方軸含油軸承
90C4-34	BEARING FOR BELL CRANK	曲柄含油軸承
90C4-42	BEARING FOR DRIVE SHAFT	傳動含油軸承
90C4-48	BEARING FOR DRIVE SHAFT (UPPER)	傳動含油軸承
90C4-58	BEARING FOR SCREW SHAFT	螺軸含油軸承
90C6-24	BALL BEARING FOR CRANK	608 滾珠軸承
142C1-7	KEY FOR GEAR.	傳動銷
300C7-1	SCREW, #4-36 X 1/8 ROUND HEAD	4-36*1/8 半圓頭螺釘
302C10-6	SCREW, #6-32 X 1/2 FLAT HEAD	6-32*1/2 沉頭螺釘
302C12-3	SCREW, #8-32 X 3/8 FLAT HEAD	8-32*3/8 沉頭螺釘
584C2-3	BELLCRANK WITH PIN & BEARING(ONLY)	方軸含油軸承
584C3-16	BELLCRANK COMPLETE WITH LEVER	曲柄組含把手
602C1-9	DRIVER PULLEY WITH DRIVER	磨擦輪
627C1-10	IDLER GEAR & BUSHING	惰輪
716C1-12	DRIVER SHAFT WITH GEAR	磨刀器傳動軸
727C1-6	OIL PAD & HOLDER	油墊托盤
17C15-82	RIVET	插銷
300C7-2	SCREW, #4-36 X 3/16 ROUND HEAD	4-36*3/16 半圓頭螺釘
1C13-13	NUT	調距套筒
53C11-109	VINYL COVER FOR CRANK	曲柄膠柄
4C1-189	JAM NUT,#8-32	鎖緊螺母
4C2-63	NUT FOR SHARPENER SHOE SCREW	磨刀靴螺母
12C15-93	WASHER, SHOE	磨擦輪
20C6-25	ADJUSTING SCREW	限位調整螺絲
20C12-143	SCREW FOR CLAMPING ARM	夾臂螺絲
20C12-153	SCREW FOR SHARPENER SHOE	磨刀靴螺絲
21C14-14	BUSHING FOR SHARPENER SHOE	磨刀靴襯套
34C10-45	SPRING FOR PULLEY SLIDE	滑輪彈簧
34C10-123	SPRING FOR ARM	夾臂彈簧
34C10-148	L.H. SHARPENER SHOE SPRING	左磨刀靴彈簧
34C10-149	R.H. SHARPENER SHOE SPRING	右磨刀靴彈簧
35C7-28	CLAMPING ARM FOR SHOE	磨刀靴夾臂
53C4-78	GEAR COVER	齒輪軸蓋
54C4-35	OIL HOLE PLUG	齒輪潤滑油蓋
62C6-31	BRACKET, LOWER GEAR	齒輪托架
70C4-32	GUIDE BACK OF STANDARD	刀夾後導板
79C12-219	WEAR PLATE	耐磨護板
87C3-50	GEAR ON SCREW SHAFT	螺軸齒輪
87C5-13	INTERMEDIATE GEAR	中間齒輪
90C4-51	BEARING FOR SCREW SHAFT	螺軸(下部)含油軸承
90C4-59	BEARING FOR SHAFT EXTENSION	延長軸含油軸承
147C1-28	R.H. SHAFT EXTENSION	右方軸延長軸
147C1-29	L.H. SHAFT EXTENSION	左方軸延長軸
152C1-19	FRONT PULLEY FOR BELT	滑輪
209C1	NEOPRENE BAND FOR PULLY	橡皮圈
300C7-3	SCREW, #4-36 X 1/4 ROUND HEAD	4-36*1/4 半圓頭螺釘
300C10-2	SCREW, #6-32 X 1/4 ROUND HEAD	6-32*1/4 半圓頭螺釘

CUTTING MACHINE SPARE PARTS FOR EASTMAN TYPE SERIES

300C10-6	SCREW, #6-32 X 1/2 ROUND HEAD	6-32*1/2 半圓頭螺釘
301C7-2	SCREW, #4-36 X 3/16 FILLISTER HEAD	4-36*3/16 球面圓柱頭螺釘
301C10-3	SCREW, #6-32 X 3/8 FILLISTER HEAD	4-36*3/8 球面圓柱頭螺釘
309C12-2	STOP SCREW, L.H. SHOE	左磨刀靴調整螺絲
712C1	R.H. SLIDE WITH PULLEY	右滑輪
712C1-1	L.H. SLIDE WITH PULLEY	左滑輪
715C1-19	LOWER GEAR BRACKET WITH COVER,SCREW,PLATE 5 - 13"	下齒輪托架和蓋子
715C1-23	LOWER GEAR BRACKET (COMPLETE)	下齒輪托架 (全套)
728C1-5	STABILIZER ASSEMBLY	定位輪架
743C1-28	R.H. PRE-SET SHARPENER SHOE (ONLY)	右磨刀靴
743C1-29	L.H. PRE-SET SHARPENER SHOE (ONLY)	左磨刀靴
820C1-7	L.H. COMPLETE SHOE ASSEMBLY,	左磨刀靴組件
820C1-8	R.H. COMPLETE SHOE ASSEMBLY,	右磨刀靴組件
12C1-35	LOCK WASHER, #8 .	外齒墊圈
17C1-4	TAPER PIN #0 X 3/4	圓柱銷
17C6-9	HINGE PIN	鉸鍊
20C5-12	CLAMP SCREW FOR ROLLERS	膠輪夾緊螺絲
20C12-19	KNIFE SLIDE SCREW	刀夾螺絲
20C13-51	HINGE PIN CLAMP SCREW	鉸鍊夾緊螺絲
34C1-57	PLATE WING TENSION SPRING	底盤翼彈簧
60C1-55	PLATE WING (FOR SMALL PLATES)	底盤翼 (小底盤專用)
60C1-56	PLATE WING (FOR LARGE PLATES)	底盤翼 (大底盤專用)
79C4-12	THROAT PLATE WITH SCREW AND PIN	喉片組件
79C4-24	TAPERED & RELIEVED THROAT PLATE ASSEMBLY	喉盤組件
213C1-1	FIBRE SHIM	調整墊片
505C3-223	SMALL PLATE BASE COMPLETE 5"-8" KNIFE	小底盤 (5-8" 刀用)
505C3-224	LARGE PLATE BASE COMPLETE 9"-13" KNIFE	大底盤 (9-13" 刀用)
528C1-116	STANDARD (COMPLETE W/SLIDER,THROAT PLATE)	10" 刀架組件
528C1-121	10" KNIFE(528C1-116) / 8" KNIFE(528C1-121)	8" 刀架組件
532C2-5	RUBBER MOUNTED ROLLER (COMPLETE)	膠輪
619C1-31	ROLLER SHELL (COMPLETE)	滑輪
643C1-43	KNIFE SLIDE (COMPLETE WITH SCREWS) 8"	刀夾 (8" 刀用)
643C1-47	KNIFE SLIDE (COMPLETE WITH SCREWS) 10"	刀夾 (10" 刀用)
529C1-8	KNIFE BOLT WRENCH	刀片螺栓套筒板手
95C5-3	ALLEN WRENCHFOR SHOE SET SCREW	六角板手
242C2-2	BEARING GREASE	軸承油脂
162C2	OIL CAN	油罐
81C1-2	SLOT CLEANSE	清槽工具
181C2-2 SP	ABRASINE BELTS	砂布帶
508C1-100	TREMINAL BLOCK	插座組
523C1-100	ATTACHMENT PLUG	插頭組



CUTTING MACHINE SPARE PARTS FOR EASTMAN TYPE SERIES

Single-Phase Motor Assemblies

<p>10A 380V 3~</p> <p>523C1-99 508C1-99</p>	<p>10A 220V 3~</p> <p>523C1-100 508C1-100</p>	<p>10A 220V ~</p> <p>523C1-1015 508C1-101</p>	<p>15A 120V ~</p> <p>523C1-102 508C1-102</p>
---	---	---	--

Description Attachment Plug Terminal Block

Note:L.H. indicates left-hand thread. All others are right-hand.

Attachment Plug Terminal Block
REFER to Back Cover for Detailed Parts List

STATOR WITH BAND
SINGLE-PHASE SINGLE-SPEED

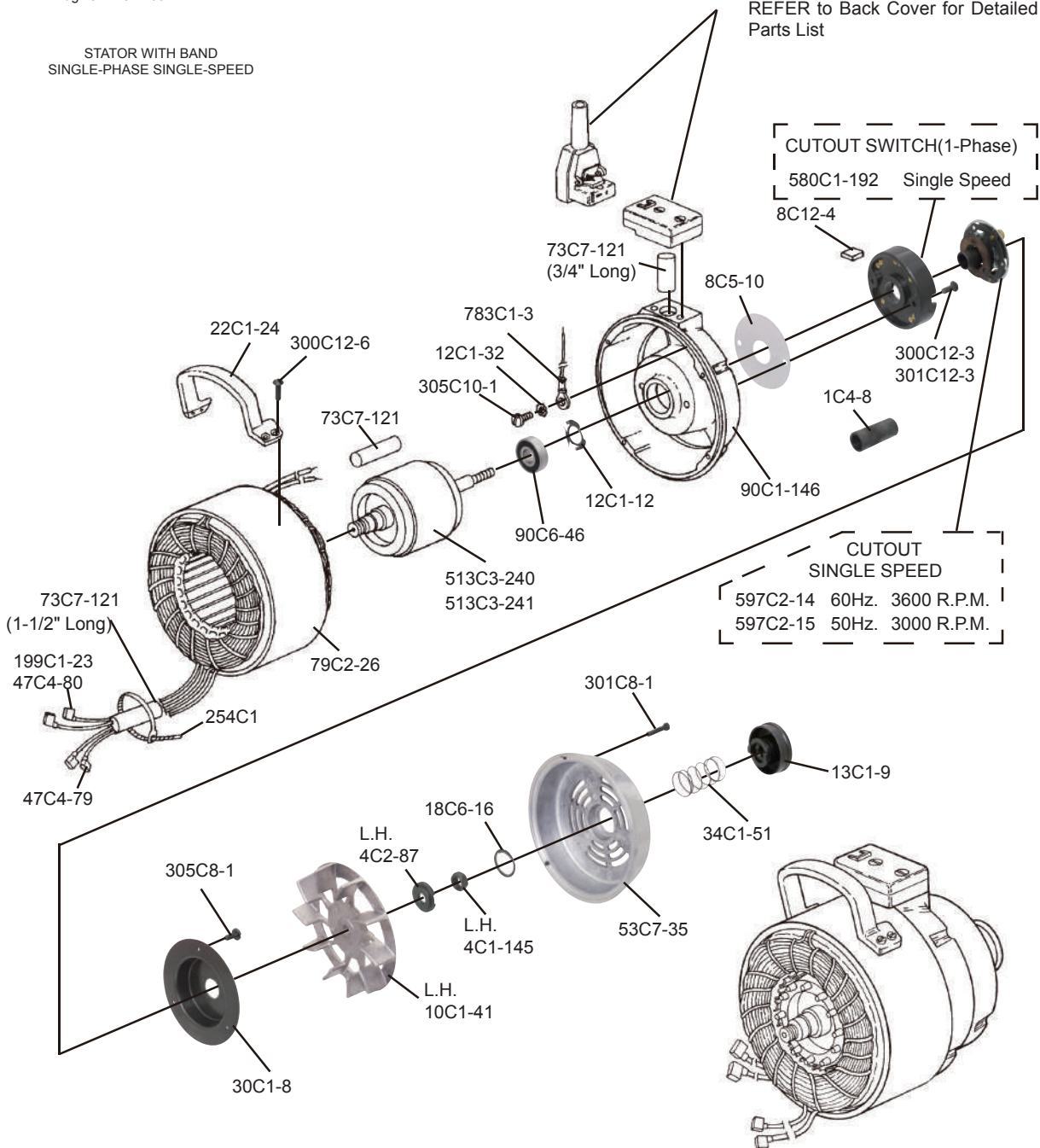



CUTTING MACHINE SPARE PARTS FOR EASTMAN TYPE SERIES

Front Bearing Housing with Oiler Assembly

Note: Certain 220 volt machines will use these capacitors. Please check the capacitor number on label of your machine to order.

706C1-4	110 Volt
706C1-5	220 Volt
706C1-13	110 Volt
706C1-18	220 Volt

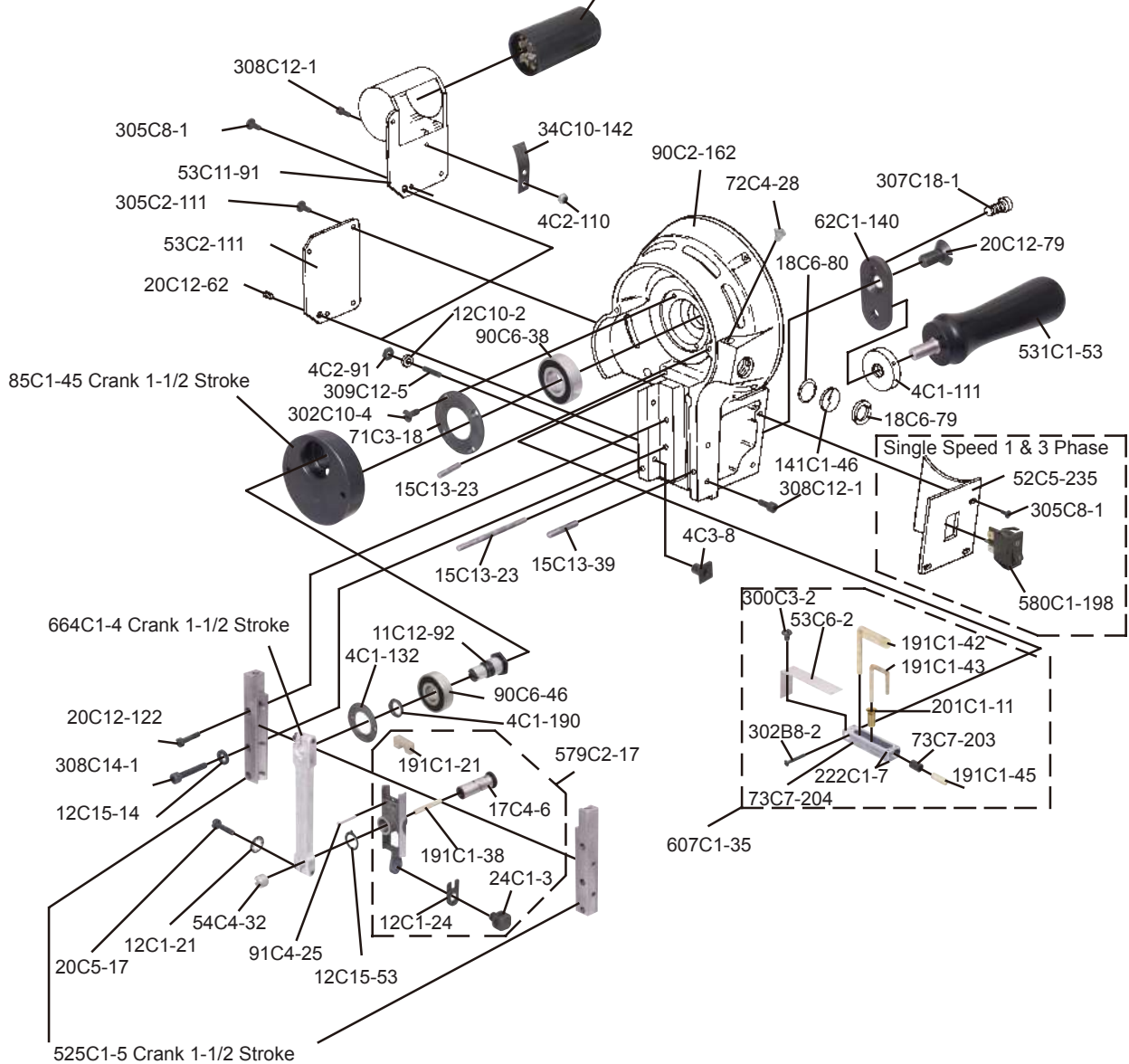

Notes: L.H. indicates left-hand thread. All others are right-hand.

Slip large lug over switch before replacing switch base. Secure switch to base tightly to ensure positive ground.



CUTTING MACHINE SPARE PARTS FOR EASTMAN TYPE SERIES

Sharpener Housing Assembly

Note:
L.H. indicates left-hand thread.
All others are right-hand.

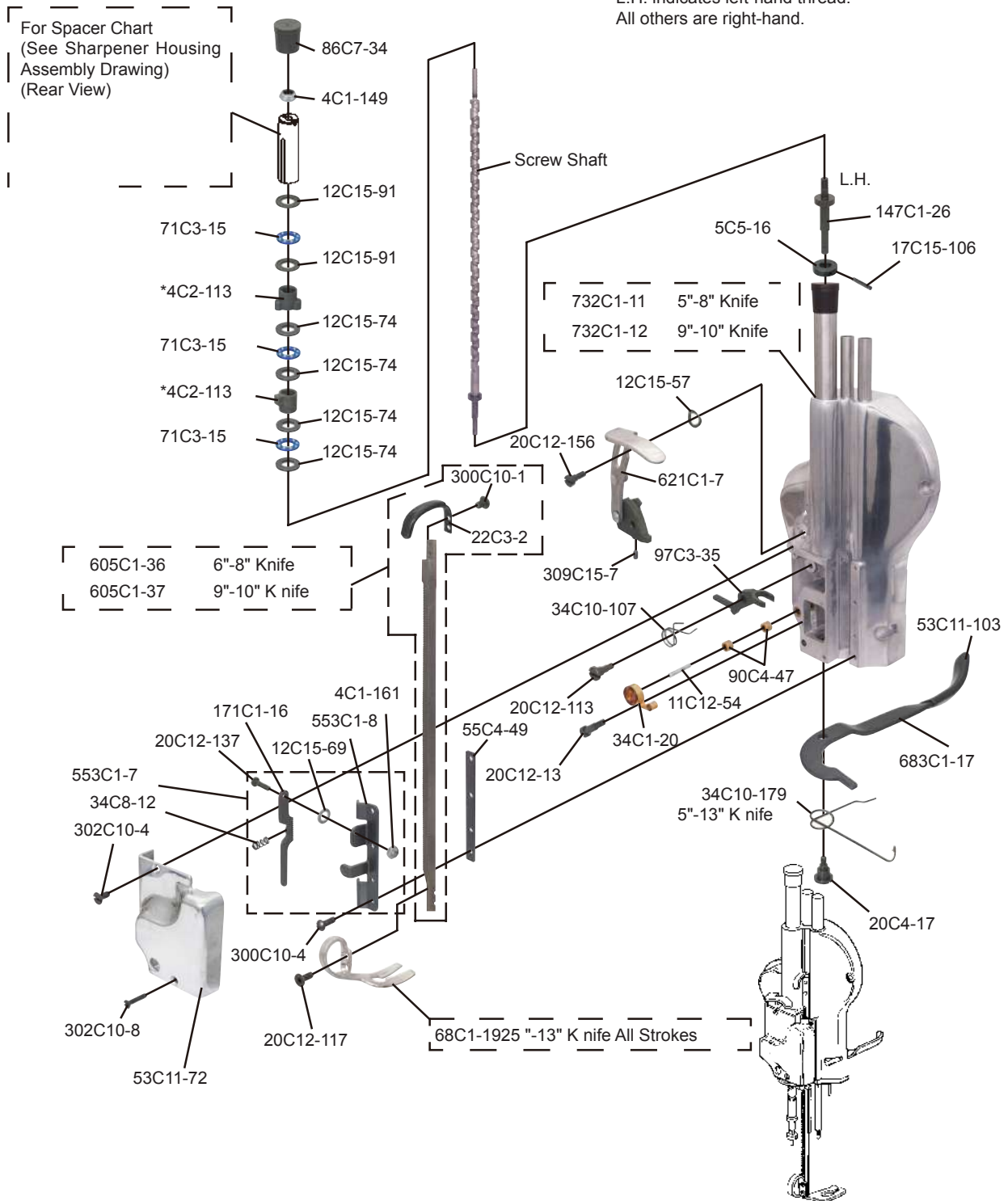



CUTTING MACHINE SPARE PARTS FOR EASTMAN TYPE SERIES

Sharpener Housing Assembly

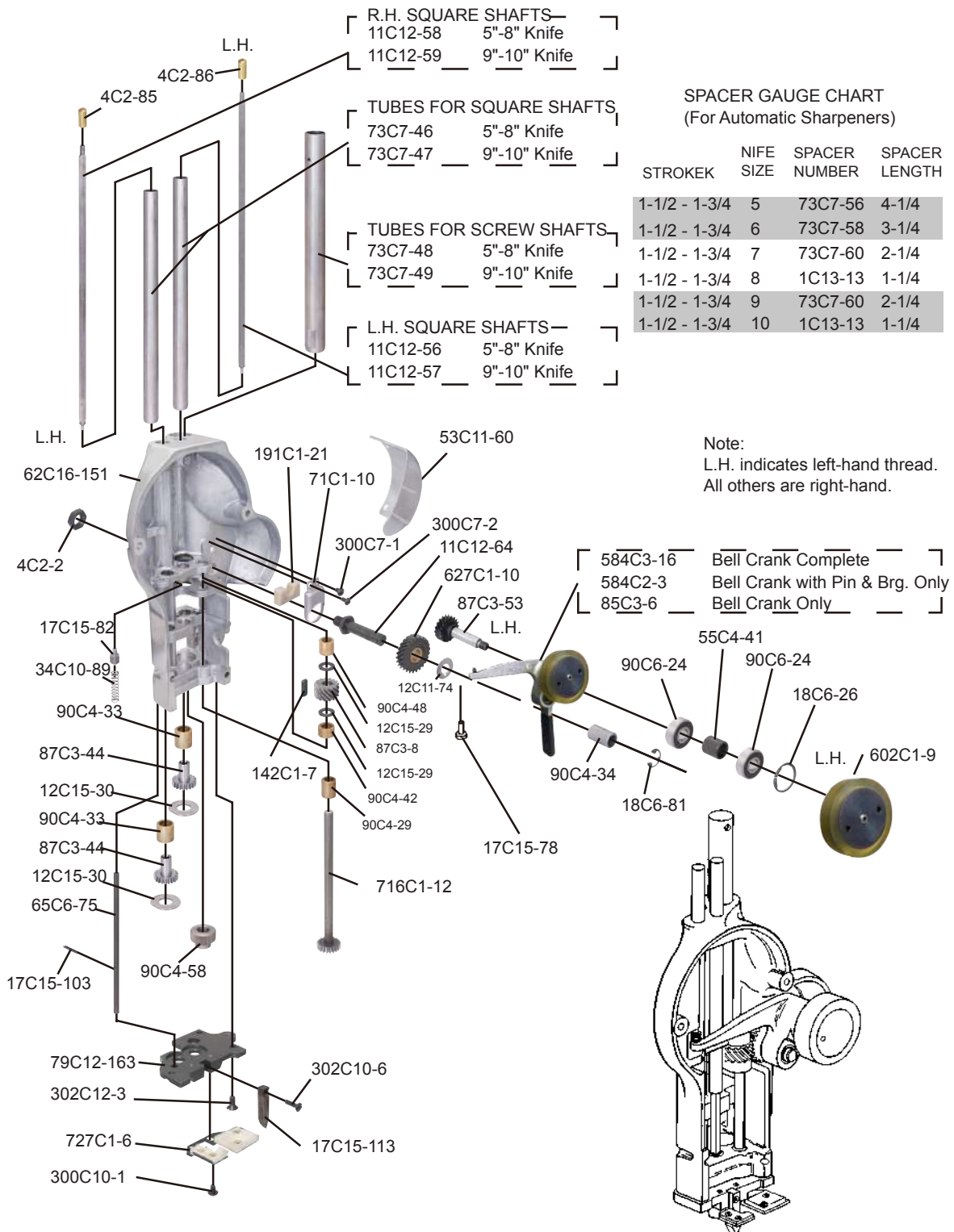



CUTTING MACHINE SPARE PARTS FOR EASTMAN TYPE SERIES

Lower Gear Bracket Assembly

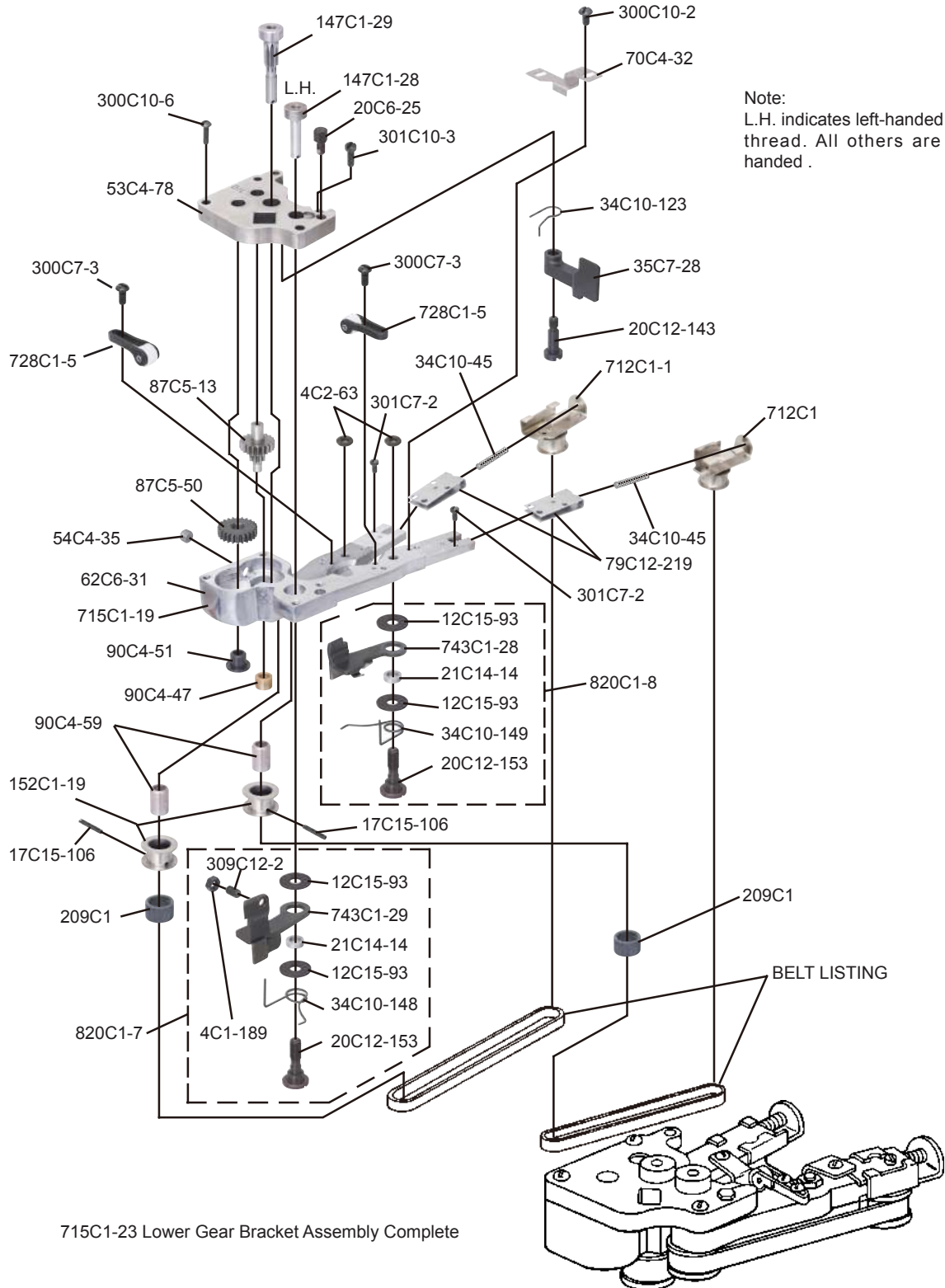



CUTTING MACHINE SPARE PARTS FOR EASTMAN TYPE SERIES

Standard and Baseplate Assembly

STANDARDS
COMPLETE W/SLIDES
528C1-121 8" Standard
528C1-116 10" Standard

KNIFE SLIDES
643C1-43 8" Knife
643C1-47 10" Knife

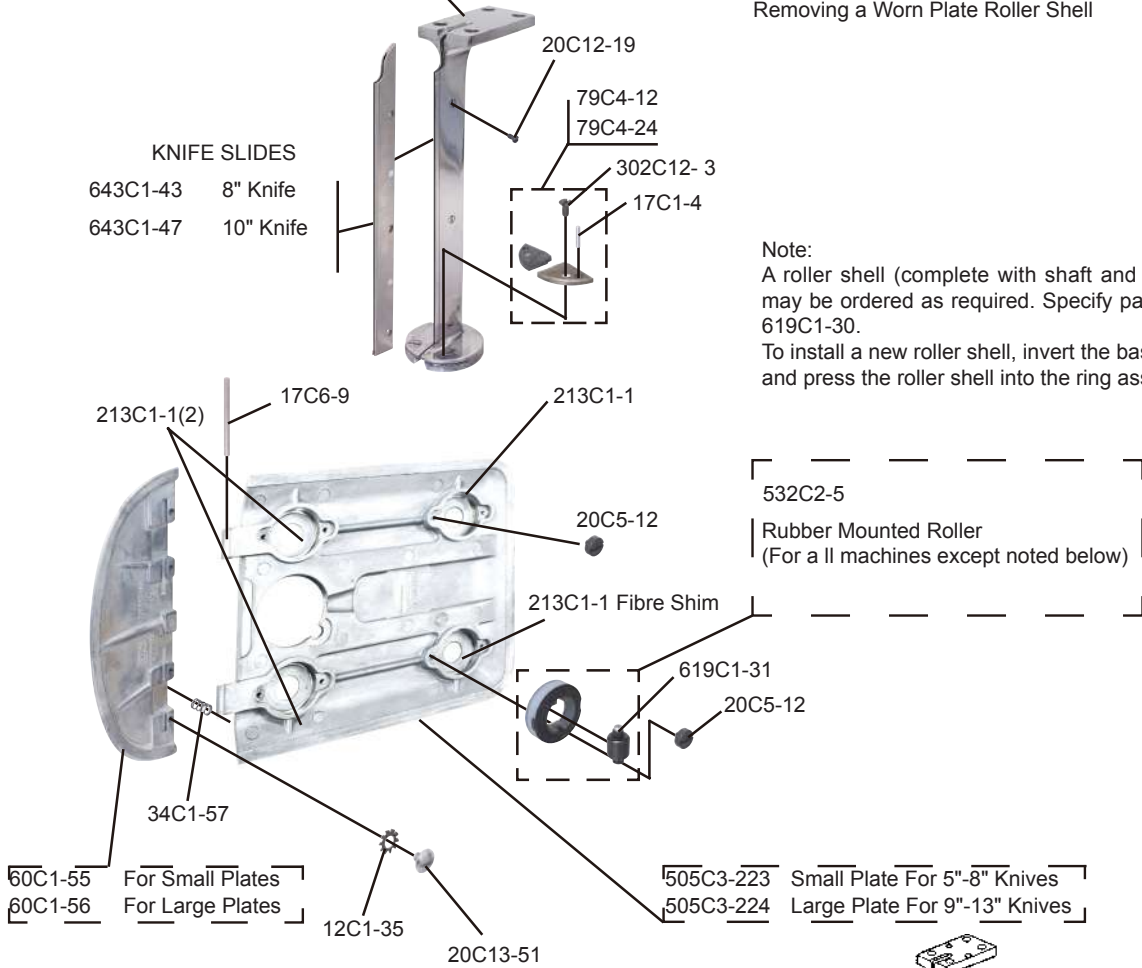

**INSTRUCTIONS
FOR REMOVING WORN
PLATE ROLLER SHELL**

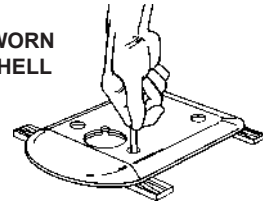

Removing a Worn Plate Roller Shell

Note:
A roller shell (complete with shaft and bearings) may be ordered as required. Specify part number 619C1-30.
To install a new roller shell, invert the baseplate and press the roller shell into the ring assembly.

532C2-5
Rubber Mounted Roller
(For a II machines except noted below)

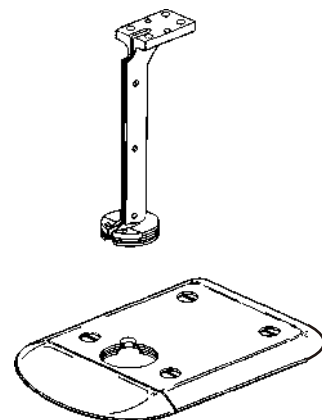



CUTTING MACHINE SPARE PARTS FOR KM TYPE SERIES

M-1	Capacitor-Stator	馬達
M-2	Carrying Handle Screws	提把螺絲
M-3	Rotor Fan	風扇
M-4	Rotor With Shaft	馬達轉子
M-6	Dust Cap Screw	離心開關蓋螺絲
M-7	Rear Bearing Housing	馬達後蓋
M-8	Dust Cap	離心開關蓋
M-9	Turning Knob	馬達旋鈕
M-13	Front to Rear Bearing Nut	馬達固定螺絲
M-14	Front to Rear Bearing Screw	馬達螺絲
M-20	Switch	單速電源開關
M-21	Clutch Spring	馬達旋鈕彈簧
M-22	Retaining Ring	後蓋卡簧
M-23	Rear Ball Bearing	馬達後蓋培琳
M-24	Spring Washer	波形墊片
M-25	Clutch Nut	離合器螺母
M-26	Shaft Lock Nut	轉子固定螺母
M-27	Crank	偏心輪
M-28	Crank Ball Bearing	偏心輪培琳
M-29	Crank Ball Bearing Lock Nut	曲輪培琳螺環
M-30	Screw for Brg Shaft	曲輪培琳軸螺絲
M-31	Shaft for Ball Bearing	曲輪培琳軸
M-32	Oil Pad Holder	油墊固定架
M-33	Oil Felt	油槽油芯
M-34	Oil Tank	油杯
M-34C	Set Oil Tank	油杯墊圈
M-35	Oil Tank Cap	油槽接頭
M-36	Connecting Rod	連杆
M-37	Shakeproof Washer	連杆墊片
M-38	Connecting Rod Clamp Screw	連杆螺絲
M-39	Wrist Pin	滑座軸
M-40	Wrist Pin Plug	滑座軸油孔螺絲
M-41	Knife Lock Washer	直刀墊片
M-42	Nuts for Guide Screw	導板調整螺母
M-43	Guide Washer	螺母墊片
M-44	Connecting Rod Washer	連杆墊片
M-45	Guide Adjusting Screw	導板調整螺絲
M-46	Guide Adjusting Nut	導板螺母
M-47	Guide Lock Screw	內六角螺絲
M-48	R.H.Guide	右滑軌
M-49	L.H.Guide	左滑軌
M-48/49	Guide	滑軌組
M-50	Cross Head	滑座
M-51	Knife Lock Bolt	直刀螺絲
M-52	Terminal Block Screw	開關螺絲
M-53	Ground Clip Screw	開關螺絲
M-54	Set Screw	油槽接頭螺絲
M-55	Front Bearing Housing	馬達前蓋
M-56	Sharpener Hold Down Screw	面具上螺絲
M-57	Retainer Screw	馬達前蓋軸承蓋螺絲
M-58	Oil Pad Holder Screw	油槽螺絲
M-59-S	Guide Hold Down Screw(S)	滑軌螺絲
M-59-L	Guide Hold Down Screw(L)	滑軌螺絲
M-60	Lower Sharpener	面具下螺母



CUTTING MACHINE SPARE PARTS FOR KM TYPE SERIES

M-60-R	Hold down Nut R	面具下螺母
M-61L	Stud Lower L.H.Mountaing(L)	左下雙頭螺栓
M-61R	Stud Lower L.H.Mountaing(R)	右下雙頭螺栓
M-63	Standard-to-Bearing Screw	刀柱固定螺絲
M-64	Front Ball Bearing	馬達前蓋培琳
M-65	Front Ball Bearing Retainer	馬達前蓋軸承蓋
M-66	Ground Clip	開關墊片
M-67	Attachment Plug Complete(3P)	3相插頭
M-68	Terminal Block Complete(3P)	3相插座
M-69	Attachment Plug (Complete)	插頭
M-70	Terminal Block (Complete)	插座
M-71	Terminal Sleeve	套筒端子
M-72	Terminal Contact with Pin	套筒端子包含銷
M-73	Operating Handle	操作手柄
M-74	Lock Nut	操作手柄調節螺母
M-75	Switch Cover Screw	防層蓋螺絲
M-76	Switch Cover	防層蓋
M-77S	GKM-AU-J-077S	前翼
M-77L	GKM-AU-J-077L	底盤
M-78	Plate Complete	底盤元件
M-80	Rubber Mounted Roler	腳墊組件
M-80C	Roller	滾輪
M-80R	Rubber	腳墊膠輪
M-81	Hinge Pin Short	轉動銷
M-82	Hinge Pin Clamp Screw	底盤螺絲
M-83	Plate Wing Tension Spring	盤翼彈簧
M-84	Knife Slide Screw	刀鞘螺絲
M-85	Standard(8")	刀柱 8"
M-85	Standard(10")	刀柱 10"
M-85	Standard(13")	刀柱 13"
M-85	Standard(6")	刀柱 6"
M-85	Standard(7")	刀柱 7"
M-86	Knife Slide(8")	8" 刀鞘
M-086	Knife Slide(10")	10" 刀鞘
M-87	Screw for Throat Plate	鎖喉片螺絲
M-88	Throat Plate	左右喉片組件
M-89	Lock Washer	底盤墊片
M-90-S	Plate Screw	刀柱定位螺母
M-90-N	Plate Nut	刀柱定位螺絲
M-92	Cap for Tube	管蓋
M-93	Driving Shaft(6"~8")	螺杆外管 6"~8"
M-93	Driving Shaft(9"~10")	螺杆外管 9"~10"
M-93	Driving Shaft(13")	螺杆外管 13"
M-94	Hand Follower(6"~8")	方軸外管 6"~8"
M-94	Hand Follower(9"~10")	方軸外管 9"~10"
M-94	Hand Follower(13")	方軸管套 13"
M-96	Screw for Latch	凸輪門螺絲
M-97	Shaft for Cam	放鬆杆彈簧銷
M-98	Cam Shaft Spring Screw	凸輪軸彈簧螺絲
M-99	Pres Foot Lock Bracket Screw	押腳杆鎖座螺絲
M-100-S	Screw for Cover(S)	凸輪蓋上螺絲
M-100-L	Screw for Cover(L)	凸輪蓋下螺絲
M-101	Cover Over Cam	凸輪蓋
M-102	Collar for Screw Shaft	軸環



CUTTING MACHINE SPARE PARTS FOR KM TYPE SERIES

M-104-R	Nut for Screw ShaftR.H	螺桿右旋螺母
M-104-L	Nut for Screw Shaft L.H	螺桿左旋螺母
M-105	Washer for Screw Shaft L.H	墊片
M-106	Screw shaft (6"~8")	雙向螺桿 (6"~8")
M-106	Screw shaft (9",10")	雙向螺桿 (9"、10")
M-106	Screw shaft(13")	雙向螺桿 (13")
M-107	Spacer tube(6")	調節螺母 (6")
M-107	Spacer tube(7",13")	調節螺母 (7"、13")
M-107	Spacer tube(8",9",10")	調節螺母 (8"、9"、10")
M-108	Stop Nut for Screw Shaft	螺桿止動螺母
M-109	Spring for Pressure Foot Lock	押腳杆鎖塊彈簧
M-110	Spring for Lateh	凸輪閥扭簧
M-111	Cam Spring	蝸旋彈簧
M-112	Pressure Foot Rod(6")	押腳杆 (6")
M-112	Pressure Foot Rod(7")	押腳杆 (7")
M-112	Pressure Foot Rod(8")	押腳杆 (8")
M-112	Pressure Foot Rod(10")	押腳杆 (10")
M-112	Pressure Foot Rod(13")	押腳杆 (13")
M-113	Screw for Pressure Foot Shoe	押腳螺絲
M-114	Pressure Foot Lever	押腳杆釋放手柄
M-115	Pressure Foot Lever Screw	釋放手柄螺絲
M-116	Spring for Pressure Foot Lever	押腳釋放杆扭簧
M-117	Set Screw for Cam	凸輪調校螺絲
M-118-C	Cam	凸輪
M-118-L	Release Lever	手把
M-118-S	Screw for cam	連接螺絲
M-119-S	Lock Screw for Releas Lever	螺桿釋放器螺絲
M-119-SW	Spring Washer	波形墊片
M-119-W	Washer	墊片
M-120	Lock(only) Pressure Foot	押腳杆銷塊
M-121-S	Screw for Pres Ft Lock	押腳杆鎖塊螺母
M-121-N	Nut for Pres Ft Lock	押腳杆鎖塊螺絲
M-122	Pressure Foot Lock Bracket	押腳杆鎖座
M-123	Slide for Pressure Foot Rod	押腳杆鎖座墊塊
M-123-2	Washer Slide for presser foot	壓腳桿滑墊片墊片
M-124	Latch for Cam	凸輪閥
M-125	Pressure Foot Shoe	押腳
M-126	Spring for Bell Crank	曲柄彈簧
M-127	Sharpener Housing(8")	面具 (8")
M-127	Sharpener Housing(13")	面具 13"
M-128	Bottom Plate Screw	上齒輪蓋螺絲
M-129	Bottom Plate	上齒輪蓋
M-130	Oil Pad & Holder	接油板組件
M-131	Screw for Oil Pad	接油板螺絲
M-132	Bell Crank With Pim & Bushing	曲柄
M-133	Screw for Cover	驅動輪蓋螺絲
M-134	Cover for Driver	驅動輪蓋
M-135	Right Hand Follower Nut	右方軸螺母
M-136	R.H.Square Shaft(6"~8")	右側方軸杆 (6"~8")
M-136	R.H.Square Shaft(9",10")	右側方軸杆 (9"、10")
M-136	R.H.Square Shaft(13")	右側方軸杆 (13")
M-136-S	R.H.Square Shaft Screw	右方軸桿螺絲
M-137	Left Hand Follower Nut	左方軸螺母
M-138	L.H.Square Shaft(6"~8")	左側方軸杆 (6"~8")

CUTTING MACHINE SPARE PARTS FOR KM TYPE SERIES

M-138	L.H.Square Shaft(9",10")	左側方軸杆 (9"、10")
M-138	L.H.Square Shaft(13")	左側方軸杆 (13")
M-138-7		左方軸桿齒輪
M-138-W	L.H.Square Shaft Washer	墊片
M-139	Push Rod	推杆
M-140	Roll Pin for Push Rod	推杆銷
M-141	Driver Shaft With Gear	齒輪驅動軸
M-142	Screw for Spreader Pin	分隔銷螺絲
M-143	Spreader Pin	分隔銷
M-144	Gear & Shaft	帶軸齒輪
M-145	Bearing for Gear	軸套
M-146	Driver Pulley(Set)	驅動輪
M-148	Spur Gear	正齒輪
M-149	Ball Bearing for Crank	曲柄培琳
M-150	Retaining Ring	曲柄輪卡環
M-151	Thrust Washers for Spiral Gear	齒輪墊片
M-152	Lock Nut for Crank Shaft	曲柄軸螺母
M-153	Shaft for Crank	曲柄軸
M-154	Washer for Crank Shaft	墊片
M-155	Lock Ring for Ball Bearing	曲柄輪卡簧
M-156	Idler Gear With Bushing	惰輪 (含軸套)
M-156-1	Bushing of Idler Gear	惰輪襯套
M-157	L.H.Spiral Gear With Key	螺旋齒輪
M-158	Screw for Gear Cover	下齒輪蓋螺絲
M-159	Screw for Gear Cover	下齒輪蓋螺絲
M-160	Grease Plug	油孔螺絲
M-161	Screw for Stabilizer	刀鞘螺絲
M-162	Lower Gear Bracket	磨刀器支架
M-162-M	Lower gear bracke	磨刀器支架
M-163	Screw for Slide Pulley	後滑輪螺絲
M-164	Lower Gear Bracker Gear Cover	支架上齒輪蓋
M-165-N	Adjusting Nut	調整螺絲
M-165-S	Adjusting Screw	調整螺絲
M-166	Gear on Screw Shaft	方孔齒輪
M-167	Intermediate Gear	傳動齒輪
M-168	Bushing for shoe	砂布推片墊片
M-169	GKM-AU-J-169	右側砂布推片
M-170	GKM-AU-J-170	左側砂布推片
M-171	Set Screw for Sharpener Shoe	砂布推片調整螺絲
M-172	Stabilizer	磨刀架穩定滑輪
M-173	Standard Guide(6"~7")	磨刀架滑輪 (6"~7")
M-173	Standard Guide(8"~10")	磨刀架滑輪 (8"~10")
M-175	Screw for Guide Back	刀柱後穩定架螺絲
M-176	R.H.Slide With Pulley	右側滑輪座
M-177	L.H.Slide With Pulley	左側滑輪座
M-178	Neoprene Band	膠套
M-179	Front Pulley for Belt	前滑輪
M-180	Roll Pin for Pulley	彈簧銷
M-181	Spring for Pulley Slide	滑輪座內彈簧
M-182	Screw for Clamping Rrm	夾臂螺絲
M-183	Clamping Arm for Shoe	夾臂
M-184	Nut for Sharpener Shoe Screw	推片螺帽
M-185	Screw for Sharpener Shoe	推片螺絲
M-186-R	R.H.Sharpener Shoe Spring	右側扭簧



CUTTING MACHINE SPARE PARTS FOR KM TYPE SERIES

M-187-L	L.H.Sharpener Shoe Spring	左側扭簧
M-188	Spring for Arm	夾臂扭簧
M-189	Abrasive Belts	砂布帶
M-190	Electric Corde Complete	電線
M-191	Knife	直刀
M-192	Knock pin for Throat Plate	喉片銷子
M-194	Knife Bolt Wrench	刀片螺栓套筒扳手
M-195	Screw Driver	螺絲起子
M-198	Bearing Grease	軸承潤滑油
M-199	Oiler	機油
M-203	Carrying Handle	提把
M-204	Capacitor Cover	電容器蓋
M-205	Screw for Capacitor Cover	電容器蓋螺絲
M-206	Capacitor	電容
M-206P	Felt	電容絕緣紙
M-208	Oil Tank Pile	導油管
M-209	Vinyl Tube	導油管
M-229	Thrust Ball Bearing	螺桿用墊片
M-230	Knob for Pressure Foot Rod	押腳杆提把
M-231	Screw for Knob	押腳杆提把螺絲
M-232	Oiling Felt for Ldller Gear	油墊
M-233	Set Screw for Oiling Felt	油墊螺絲
M-301	Automatic Cut-Out Switch	離心開關
M-302	Automatic Cut-Out	離心開關
M-303	Insulated Plate	離心開關絕緣紙
M-304	Set Screw	螺絲
M-305	Spring Washer	墊片



裁布機的專家 - 專業生產技術及開發設計製造裁布機設備



提供專業化及客製化生產直立式裁布機，機台尺寸可依客戶需求製作，目前提供 8 吋及 10 吋機種客製化。

本機採用台灣生產大功率馬達，裁切速度快，具備優異輸出能效。具備有平視觀察油孔，方便油料添加。

切口平直且能以小幅度半徑曲線切割，低噪音、轉速平穩、操作簡便，並有自動磨刀功能，是服裝製造業最理想的裁切設備。

Professional and customized cutting M/C from 8" and 10".

Embedded with high efficiency MIT motor, faster cutting speed! Easy to check oil level, convenient to refill!

Low noise, stable motor speed, easy to operate, and auto grinding function. Your best choice in cutting M/C!

產品規格 Technical Specifications

Motors	110V, 1ph, 50/60Hz 220V, 1ph, 50/60Hz Standard: Single Speed High Power: Single Speed
Horsepower	.65hp, 1ph / 1.25hp, 1ph
Weight	34 lbs.(15.4KG)
Blades	Alloy Steel, Super Alloy Steel, High Speed Steel, Non-Stick Coating, Wave Edge
Belts	Coarse Grits 80, Medium Grits 100, Fine Grits 120
Blades Size	8in. / 10 in.



裁布機的專家 - 專業生產技術及開發設計製造裁布機設備



lubrication hole convenient to refill oil
外置油孔補充油料免拆機



easy to check oil level
油量可視槽更方便確認油量

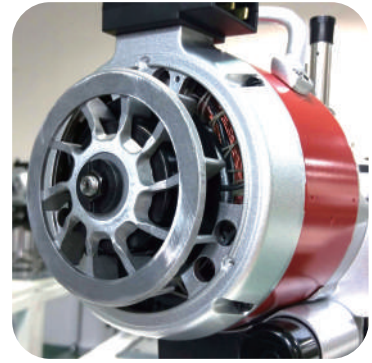

high efficiency MIT motor
faster cutting speed
台灣製馬達機芯更高效輸出



special design avoidance
abrasive belt loose
特殊磨刀器設計 有效避免脫帶



MIT capacitor voltage is more stable
台灣電容使用 電壓更穩定安全



High texture Solid wood
carrying handle
高質感實木烤漆手柄 手感舒適





0246002553	26	10E-HSS	2	118-45708	8
030-0095-00	14	10ET	2	118-45807	8
030-0096-00	14	10ET-HSS	2	118-45906	8
030-0097-00	14	10EW	2	118-46003	8
030-0098-00	14	10EW-HSS	2	118-47407	8
030-0461-00	14	10EWT	2	118-47506	8
0746060689	26	10EWT-HSS	2	118527-0-01	14
0746060691	26	10H	4	118-69005	100
0746060692	26	10HW	4	118-69658	100
07-124	10	10K	5	118-70359	100
07-168	10	10KM	3	118-70458	100
07-169	10	10KM-7 Super Alloy	3	118-82107 + 118-87007	76
07-170	10	10KM-HSS	3	118-82107 + 118-87106	76
07-206	10	10KMW	3	118-82404 + 118-87106	76
07-406	10	10KMW-HSS	3	118-82800 + 118-87403	76
07-505	10	10L	5	118-83006 + 118-87304	76
07-507	10	10M	6	118-84004 + 118-87403	77
07-558	10	10M-SLIDER-HSS	6	118-85209	76
07-570	10	10MW	6	118-85407	76
07-702	10	10W	5	118-85407	76
07-703	10	10WW	5	118-86009	76
07-707	10	113	11	118-86504	76
08-281	27	11442	27	118-86504	76
08-282	27	11 1/2E	2	119-49807 + 118-87106	76
100 1"	49	11 1/2E-7 Super Alloy	2	119-49906	76
100 1/2"	49	11 1/2E-HSS	2	119-99307	96
100 3/4"	49	11 1/2ET	2	11C	4
100 3/8"	49	11 1/2ET-HSS	2	11M	6
100 5/8"	49	110-1	11	11M-SLIDER-HSS	6
100 7/8"	49	110-40052	32	12482	71
100-01709	32	110-40052	40	12701	108
10-001A-2700	41	110-40201	33	12800	108
10-001A-64L7	41	110-42652	33	12801	108
10-005A-2700	41	110-93259	33	121946	93
10-006A-235B	41	110-95403	33	127233	93
10-101A-2700	41	112436-0-01	14	127734001	27
10-106A-2700	41	113-13053	33	120-04909	8
102-11100	32	113-51400	33	121-48607	100
102-11209	32	113-51509	33	121-48706	100
102-11605	32	113-HSS	8	121-49803	100
10-3072-0-014	46	114-09257	33	121-50306	100
10-3072-0-024	46	114-09604	33	121-50603	100
10-4600-0-000	38	114-HSS	8	121-72805	76
105306-101	29	115069-001	96	121-73209	76
105307-101	29	115-65900	8	121-73308	76
107-26305	32	115-66502	8	121947H	93
10C	4	115-90	9	121950H	93
10CW	4	115-97101 + 118-87106	76	123-HSS	8
10E	2	115-97101 + 118-87106	77	124-19602	33
10E-7 Super Alloy	2	118-45609	8	12435HN	93



12435N	93	12ET-HSS	2	146781-001	63
12435R 1/4	92	12EW	2	147150LGW	72
12435R 1/8	92	12L	5	14-7900-0	65
12435R 3/16	92	137562	11	14-7910-0	65
12435W	93	138559	11	147-HSS	8
124-47504	8	131-16702	33	14-8190-0	65
12463HL 1/16	91	131-50503	8	148198-0-01	14
12463HL 1/2	91	131-50602	9	14-8200-0	65
12463HL 1/32	91	131-50701	9	14-8460-0	65
12463HL 1/4	91	131C1-12	108	14-8470-0	65
12463HL 1/8	91	133C1-11	108	14-8540-0	65
12463HL 3/16	91	133C1-12	108	14-8560-0	65
12463HL 3/32	91	133C1-14	108	14-8580-0	65
12463HL 3/8	91	133C1-25	108	14-8640-0	65
12463HL 5/16	91	137-31161	33	14-8660-0	65
12463HL 5/32	91	137-35451	33	14-8680-0	65
12463HR 1/16	91	137-35469	33	148815-0-01	8
12463HR 1/2	91	137-35956	33	14-8900-0	65
12463HR 1/32	91	137-36103	33	14-8910-0	65
12463HR 1/4	91	13E	2	149-HSS	8
12463HR 1/8	91	13E-7 Super Alloy	2	14L	5
12463HR 3/16	91	13E-HSS	2	14M	6
12463HR 3/32	91	13ET	2	14W	5
12463HR 3/8	91	13ET-HSS	2	15710	10
12463HR 5/16	91	13EW	2	15722	10
12463HR 5/32	91	149057	86	15730	10
124-76305+ 124-80307	77	149165	86	15740	10
124-78301	76	1426970	11	150793	86
12481-11	86	1429970	11	150789-001	94
12481-13	86	1430370	11	152897-0-01	29
12481-15	86	1430770	11	152901-0-01	29
12481-17	86	1431170	11	152905-0-01	29
12481-19	86	1437070	11	152906-0-01	29
12481-22	86	140242-0-01	14	152981-0-01	29
12481-9	86	140-41206	33	15-3010-0	78
1250004-229B	23	140888-001	29	153020-001	29
1250004-237B	23	141509-0-01	29	15-3610-0	78
1250014-229	23	141512-001	29	154568-001	29
1270004-229	23	141513-001	29	155193-0-01	14
127734-0-01	14	141541-0-01	29	15-7040-0	78
12-8010-1	100	141543-0-01	29	15-7230-0	78
12-8020-1	100	142058N	93	15-7270-0	78
12-8380-0	100	143169W	72	15-7530-0	78
12-8390-0	100	144074-0-01	14	15-7560-0	78
129-17-185-3	29	144074-300	14	15-7600-0	78
129-22704	33	146567-001 + 146577-001	74	15-805-0	78
12C	4	146568-001 + 146577-001	74	15-8060-0	78
12E	2	146569-001 + 146577-001	74	15-8070-0	78
12E-7 Super Alloy	2	146744-001 + 146577-001	75	15-8070-0	78
12E-HSS	2	146744-001 + 146577-001	75	15-808	78





15-8110-0	78	20496	25	202146-0-10	20
15-8120-0	78	200971	11	202194-0-10	39
15-8230-0	78	201127	11	202527A	11
15-8440-0	78	202295	11	202554E	66
159274-001	29	202408	96	202618A	66
159276-001	29	202451	37	202854A	79
159540-001	29	202527	11	202932-0-10	20
159541-001	30	202570	11	203010-0-10	20
15E	2	202572	12	203012-0-10	20
15E-7 Super Alloy	2	202573	12	203066-0-10	20
15E-HSS	2	202675	66	203069-0-10	20
160342	94	202702	66	203144-0-10	20
164037	22	202828	96	203759-0-10	20
164233	22	202893	12	203783-0-10	20
164308	22	204072	96	204161A	12
164550	22	204161	12	204360A	66
164556	23	204351	12	204676-BF	79
164728	23	204367	66	204693-0-10	20
164809	23	204528	66	204693-0-11	20
164813	23	204529	66	204730A16F	79
164861	39	204703	97	204730-BF	79
16409906	33	205255	66	204730-BF	80
16010(4)	10	205258	12	204949 (11)	96
16022(4)	10	205773	66	205-9101-01A	14
16057(4)	10	205890	12	205-9102-01A	14
16092(6)	10	208063	79	207000-2-00	20
16110(6)	10	208064	79	207001-2-00	20
16120(8)	10	208064	81	207002-2-00	20
164-03008	33	208066	79	207003-2-00	20
164-16109	9	208066	81	207004-2-00	20
164-18709	9	208215	79	207006-2-00	21
1650004-229	23	208217	79	207015-2-00	21
165010H	93	208217	80	207016-2-00	21
166-07301	33	208219	79	207017-2-00	21
166-07400	33	208219	80	207020-2-00	21
166-07509	33	208504	89	207020-2-01	21
166-07608	33	208905	99	208078-BF	79
166-07707	34	208910	99	208090A16F	79
166-07806	34	208911	81	208090-BF	79
17-0064-5-864 (CA)	46	202554E1	66	208909B92	99
179630-92	99	20002 FOR A10	86	209670-92	99
19336	93	201094B	79	210	90
19-431	96	201121A	11	211	90
19-431-A	96	201121ANS	11	212	90
19-431-N	96	201230C	89	213	90
19-431-S	96	201230C	89	214	90
19-437	96	201230C	89	21787	70
20271	42	201308P	37	211662	12
20491	25	202142-0-10	20	2100167	25
20493	25	202143-0-10	20	2101155	25



2101156	25	246071	37	270-112/1	21
2108000	70	24739(4)	10	270-113	21
2108003	70	24741(6)	10	270-113/1	21
2108004	70	257550	96	270-188	39
2108005	70	257573	37	2701P9-113/1	21
2108052	70	257574	38	276B-112	21
2109000	84	257018B56	66	277022-92	99
2109005	84	257018B64	66	277027-92	99
2109055	84	257033B56	66	277028-92	99
2109100	100	257033B64	66	277029-92	99
2109112	100	257053B56	66	277-112	21
2109300	97	257053B64	66	277-113	21
2111055	25	257206-16F	80	277300-16	79
2111056	25	257207-16F	79	277302-16	79
2114012	25	257207-16F	80	277303-16	79
2114013	25	257215-16F	80	277303-16	81
2121111	25	257216-16F	79	277305-16	79
2150256	26	257221-16F	81	277305-16	80
2109001 + 2109067	84	257222-16F	79	277323-16	80
2109006 + 2109067	75	257242-16F	81	277325-16	80
2109006 + 2109067	75	257243-16F	81	277327-16	80
2109006 + 2109067	84	257258-16F	80	277327-16	81
2109056 + 2109052	84	257259-16F	79	277329-16	80
211-13	91	257261-16F	80	277329-16	80
211-14	91	257262-16F	79	277330-16	80
2111407-553B	41	257267-16F	80	277337- 25	80
2111417-556B	41	257268-16F	79	277339-25	80
211-15	91	257289-16F	80	277500P30	66
211-16	91	257290-16F	80	277500P40	66
211-18	91	257321A56	90	277505R30	66
211N	90	257331A56	90	277505R40	66
21-5602	26	257518-56	99	277505R50	66
215R	90	257518-64	99	277513R30	66
216R	90	257573A	37	277513R40	66
218R	90	259101-16F	81	277513R50	67
21R	90	259103-16F	81	277516R40	67
220	90	259203-16F	80	277516R50	67
221	90	259215-16F	80	277517R40	67
22195	25	2615	27	277517R50	67
221N	90	2626	108	277524T50	67
226-55302	34	262327	108	277524T60	67
22L	90	261416-2	27	2777-112	21
236606	37	2626-S	108	2777-1121	21
236608	37	272153	86	279-112	21
23420Z-9 1/8H	49	277009	12	279-113/1	21
23420Z-9 1/8MH	49	277034	96	28964	24
23420Z-9 1/8XH	49	277118	89	290-112	21
235-06009	34	277119	89	290-113	21
235-06108	34	277122	90	290-113SP	21
246061	37	270-112	21	30421	25





300417	26	3209001	85	350218	38
306394	12	3209002	84	350220	38
3021060	42	3209002	85	3501026	43
3021061	42	3209003	84	3501032	43
3021109	42	3209003	85	3501535	43
3021111	42	3209008	84	3501597	43
302807-0-10	21	3209009	84	350018-91	38
302808-0-10	21	3209107	101	3544A	11
303-65407	34	3209108	101	35796B	43
305-00300	34	32063000	34	35796C	43
3100512	42	32063109	34	36250	24
3100513	42	32063208	34	36270	24
3100708	42	320-16107	34	36069DG 1/4	91
3101026	42	320-18012	34	36069DG 1/8	91
3101028	42	320-18509	34	36069DG 3/16	91
3101465	42	320-20505	34	36069L 1/2	91
3101633	42	320-20604	34	36069L 1/4	91
3101699	42	320-20703	34	36069L 1/8	91
3101700	42	320-20919	34	36069L 3/8	91
3101801	42	320-23210	34	37469	25
3101802	42	320-23319	34	37472	26
3108134	70	32-2047-1-001	38	37514	26
3109000	84	32-2047-1-002	38	37538	26
3109001	84	32-2048-1-001	38	37469-HSS	25
3109002	84	32-2048-1-002	38	37472-HSS	26
3109003	84	323-870-005	12	381A	108
3109020	84	323-870-200	12	39549	24
3109021	84	323-870-202	12	39570	24
3109300	97	323-870-203	12	39270A	24
3110037	42	323-870-207	12	39549J	24
3110038	42	323-870-210	12	39549N	24
3159037	85	323-870-211	12	39570J	24
312-870-001	12	323-870-212	12	39570K	24
312-870-003	12	323-870-213	20	40026155	34
31358HN	93	323-870-214	20	40050589	34
31358HW	93	323-870-215	20	40089755	34
31358HXW	93	323-870-218	20	400/7	109
31358L 1/4	92	323-873-001	38	40-0012-1-045	38
31358L 1/8	92	323-873-200	38	40-0012-2-045	39
31358L 3/16	92	33353	70	400-04255	35
31358N	93	33545	70	400-04311	35
31358W	93	330N	108	400-12403	35
32667	70	34598	70	400-12404	35
32672	70	34749A	34	40-0127-1-000	39
32914	25	34749EL	43	40-0127-2-000	39
3201062	43	34770AH	34	400-15996	35
3209000	84	3543	11	400-38091	35
3209000	85	35285	25	400-38754	35
3209000	85	35286	25	400-39364	35
3209001	84	350024	38	400-42378	35



400-76709	35	55459	39	80C1-101	8
40322SH	93	56065	72	80C1-114	8
405-9101-01A	14	60507	14	80C1-123	8
408-9101-01B	14	60544	14	80C1-133	8
408-9102-01A	14	611325N	9	80C1-141	8
416	109	6200022	26	80C1-147	8
410295	23	6200097	26	80C1-149	8
412544	23	6200308	26	80C1-39	8
412585	23	6378-112	21	80C1-59	8
412749	23	6378-113	22	80C1-61	8
414029	39	643C1-41-HSS	2	82012	42
414030	39	643C1-42-HSS	2	91-171853-05	38
4126371	11	643C1-45-HSS	2	93357	101
42305	22	643C1-46-HSS	2	93358	101
42309	22	643C1-53-HSS	2	94411	42
42-0012-0-045	39	643C1-54-HSS	2	94417	42
428-9101-01B	14	68095	85	94801	70
45483	108	68096	85	94802	70
46377(6)	10	68121	42	94902	70
46378(4)	10	68184	42	95085	70
470	27	71-90 1	45	95276	26
471	27	71-90 1/2	45	95277	26
47014	10	71-90 3/4	45	95399	42
47409	12	71-90 3/8	45	99601	86
47409	12	71-90 5/8	45	1-MS-55	9
47410	12	71-90 7/16	45	2(6)KURIS	10
47410	12	71-90 7/8	45	2(6)KURIS	10
48-1125-5-721	39	71-90 9/16	45	2B0010	12
508 1"	49	71CL 1	45	3-MS-2	9
508 3/4"	49	71CL 1 1/4	45	4E	2
508 5/8"	49	71CL 1 1/8	45	4E-7 Super Alloy	2
508 7/8"	49	71CL 1 3/8	45	4E-HSS	2
508LS 1-1/2"	49	71CL 1/2	45	4ET	2
508LS 1-1/4"	49	71CL 1/4	45	4ET-HSS	2
508LS 1-1/8"	49	71CL 11/16	45	4H	4
508LS 1-3/4"	49	71CL 3/4	45	4KM (N)	3
508LS 1-5/8"	49	71CL 3/8	45	4KM (N)-7 Super Alloy	3
508LS 1-7/8"	49	71CL 5/16	45	4KM (N)-HSS	3
508LS 2"	49	71CL 5/8	45	4M	6
513	109	71CL 7/16	45	4W	5
5140008-413	24	71CL 7/8	45	5C	4
5150002-321	24	71CL 9/16	45	5E	2
5150002-324	24	755106	27	5E-7 Super Alloy	2
5150007-311	24	755128	27	5E-HSS	2
5150007-321	24	7506-1	109	5ET	2
5150008-413	24	7506-2	109	5ET-HSS	2
525	108	784045	11	5EW	2
54247	93	784048	11	5EW-HSS	2
540741	39	784045008	11	5EWT	2
540760	39	784048001	11	5EWT-HSS	2



5H	4	7EWT	2	9H	4
5HW	4	7EWT-HSS	2	9HW	4
5KM (N)	3	7H	4	9KM	3
5KM (N)-7 Super Alloy	3	7HW	4	9KM-7 Super Alloy	3
5KM (N)-HSS	3	7K	5	9KM-HSS	3
5KMW	3	7KM	3	9KMW	3
5KMW-HSS	3	7KM-7 Super Alloy	3	9KMW-HSS	3
5M	6	7KM-HSS	3	9M	6
5W	5	7KMW	3	9M-SLIDER-HSS	6
6-90	10	7KMW-HSS	3	9MW	6
6-91	10	7M	6	9W	5
6-91E	10	7MW	6	9WW	5
6-91F	10	7W	5	A-113	9
6C	4	7WW	5	A-113®	9
6CW	4	8C	4	A-113-HSS	9
6E	2	8CW	4	A-114	27
6E-7 Super Alloy	2	8E	2	A-118	109
6E-HSS	2	8E-7 Super Alloy	2	A-121-1	37
6ET	2	8E-HSS	2	A-90-3	10
6ET-HSS	2	8ET	2	A-90-7	10
6EW	2	8ET-HSS	2	A10 16 mm	49
6EW-HSS	2	8EW	2	A10 18 mm	49
6EWT	2	8EW-HSS	2	A10 20 mm	49
6EWT-HSS	2	8EWT	2	A10 22 mm	49
6H	4	8EWT-HSS	2	A10 24 mm	49
6HW	4	8H	4	A10 26 mm	49
6K	5	8HW	4	A10 28 mm	49
6KM	3	8K	5	A10 30 mm	49
6KM (N)	3	8KM	3	A10 32 mm	49
6KM (N)-7 Super Alloy	3	8KM-7 Super Alloy	3	A10 34 mm	49
6KM (N)-HSS	3	8KM-HSS	3	A10 36 mm	49
6KM -HSS	3	8KMW	3	A10 38 mm	49
6KM-7 Super Alloy	3	8KMW-HSS	3	A10 40 mm	49
6KMW	3	8L	5	A10 45 mm	49
6KMW-HSS	3	8M	6	A10 50 mm	49
6L	5	8M-SLIDER-HSS	6	A10-NP N0.1	72
6M	6	8MW	6	A10-NP N0.2	72
6M-SLIDER-HSS	6	8W	5	A10-NP N0.3	72
6MW	6	8WW	5	A10-NP N0.4	72
6W	5	9C	4	A11 / S72L 10 mm	50
6WW	5	9CW	4	A11 / S72L 13 mm	50
7C	4	9E	2	A11 / S72L 15 mm	50
7CW	4	9E-7 Super Alloy	2	A11 / S72L 16 mm	50
7E	2	9E-HSS	2	A11 / S72L 18 mm	50
7E-7 Super Alloy	2	9ET	2	A11 / S72L 19 mm	50
7E-HSS	2	9ET-HSS	2	A11 / S72L 20 mm	50
7ET	2	9EW	2	A11 / S72L 22 mm	50
7ET-HSS	2	9EW-HSS	2	A11 / S72L 25 mm	50
7EW	2	9EWT	2	A11 / S72L 28 mm	50
7EW-HSS	2	9EWT-HSS	2	A11 / S72L 3 mm	50



A11 / S72L 30 mm	50	A9 1"	49	B2001-771-OAO	35
A11 / S72L 32 mm	50	A9 1-1/2"	49	B2003-761-000	35
A11 / S72L 35 mm	50	A9 1-1/4"	49	B2003-771-000	35
A11 / S72L 40 mm	50	A9 1-1/8"	49	B2030-380-000	96
A11 / S72L 45 mm	50	A9 1-3/4"	49	B2031-380-000	96
A11 / S72L 5 mm	50	A9 1-5/8"	49	B22	71
A11 / S72L 50 mm	50	A9 1-7/8"	49	B24	71
A11 / S72L 6 mm	50	A9 2"	49	B2406-373-0A0	35
A11 / S72L 8 mm	50	A9 3/4"	49	B2406-761-0A0	36
A225E	92	A9 5/8"	49	B2406-771-0A0	36
A30 / 121586 1/4H	50	A9 7/8"	49	B2408-761-000	36
A30 / 121586 1/4L	50	ABRASIVE BELTS	107	B2408-771-000	36
A30 / 121586 1/4M	50	ACE	27	B2410-373-000	36
A30 / 121586 1/4MH	50	AS1026	10	B2421-210-AAO	36
A30 / 121586 1/4XH	50	AS1026	10	B2421-280-000	36
A30 / 121586 1/4XL	50	AT0204000000	41	B2421-280-0A0	36
A30 / 121586 3/16H	50	B	23	B2424-210-AOO	36
A30 / 121586 3/16M	50	B-2002-761-OAO	35	B2424-210-OOO	36
A30 / 121586 3/16MH	50	B-2002-771-OAO	35	B2424-280-000	36
A30 / 121586 3/16XH	50	B-2421-205-OAO	36	B26	71
A4 1"	49	B-2421-210-000	36	B28	71
A4 1/2"	49	B1109-415-H00	72	B30	71
A4 3/4"	49	B1109-555-HOB	72	B4108-352-000	9
A4 3/8"	49	B1130-026-000	35	B4108-352-00B	9
A4 5/8"	49	B1131-026-000	35	B4108-352-00B(L)	9
A4 7/8"	49	B1190-522-SOO	47	B4108-352-00D	9
A400 1/16"	51	B1190-522-TOO	47	B4111-804-00A	9
A400 1/2"	51	B1190-522-UOO	47	B4111-804-00C	9
A400 1/4"	51	B1190-522-VOO	47	B4118-804-000	9
A400 1/8"	51	B1190-522-XOO	47	B4118-804-00C	9
A400 3/16"	51	B1190-522-YOB	47	B4121-052-AAO	47
A400 3/8"	51	B1239-372-OOO	96	B4121-522-000	47
A4113-102-000	9	B14	71	B4121-522-000-L	47
A4142-335-000	9	B1528-380-0A0	35	B4122-352-000	9
A4145-335-000	9	B1528-804-000	35	B4122-352-00A	9
A70 / S70 1/16	50	B1528-804-000A	35	B4122-354-00A	9
A70 / S70 1/2	50	B1530-352-000	35	B4122-357-00D	9
A70 / S70 1/4	50	B16	71	B4145-530-BOO	47
A70 / S70 1/8	50	B1609-415-HOB	86	BAND KNIVES	106
A70 / S70 3/16	50	B1613-522-NOO	86	BK-10F	39
A70 / S70 3/8	50	B1613-522-WOO	86	BK213 3/8" M	57
A70 FEED DOG	86	B1613-555-HOO	86	BL339 1 1/2"-3/4" H	59
A702	39	B1657-804-OOT	76	BL339 1 1/2"-3/4" XH	59
A703	39	B1657-804-OOT	76	BL339 1 1/4"-5/8" H	59
A75D 1/2"	50	B1657-814-BOE	76	BL339 1 1/4"-5/8" XH	59
A75D 1/4"	50	B1657-814-BOE	76	BL339 1 3/4"-7/8" H	59
A75D 3/8"	50	B18	71	BL339 1 3/4"-7/8" XH	59
A75U 1/2"	51	B20	71	BL339 1"-1 1/2" H	59
A75U 1/4"	51	B2001-761-OAO	35	BL339 1"-1 1/2" XH	59
A75U 3/8"	51	B2001-762-OAO	35	BL339 2"-1" H	59



BL339 2"-1" XH	59	BP206 1" S	56	CH502 1/8" M	58
BL339 3/4"-3/8" H	59	BP206 7/8" M	56	CH502 1/8" S	58
BL339 3/4"-3/8" XH	59	BP206 7/8" S	56	CH502 3/16" M	58
BL340 1 1/8" H	61	BP207 1 1/2" M	56	CH502 3/16" S	58
BL340 1 1/8" XH	61	BP207 1 1/2" S	56	CH503 1/4"	59
BL340 1 1/8"-1/2" H	60	BP207 1 1/4" M	56	CH503 1/8"	59
BL340 1 1/8"-1/2" XH	60	BP207 1 1/4" S	56	CH503 3/16"	59
BL340 1 3/8" H	61	BP207 1 1/8" M	56	CH503 5/16"	59
BL340 1 3/8" XH	61	BP207 1 1/8" S	56	CL 1/16	90
BL340 1 3/8"-5/8" H	60	BP207 1 3/16" M	56	CL 1/16E	90
BL340 1 3/8"-5/8" XH	60	BP207 1 3/16" S	56	CL 1/16N	90
BL340 1 5/8" H	61	BP207 1 3/8" M	56	CL 1/16NS	90
BL340 1 5/8" XH	61	BP207 1 3/8" S	56	CL 1/32	90
BL340 1 5/8"-3/4" H	60	BP207 1" M	56	CL 1/32E	90
BL340 1 5/8"-3/4" XH	60	BP207 1" S	56	CL 1/32N	90
BL340 1 7/8" H	61	BP207 3/4" M	56	CL 1/32NS	90
BL340 1 7/8" XH	61	BP207 3/4" S	56	CLEANING GUN	107
BL340 1 7/8"-7/8" H	60	BP207 7/8" M	56	CP201 1 3/4"-1" M	55
BL340 1 7/8"-7/8" XH	60	BP207 7/8" S	56	CP201 1 3/4"-1" S	55
BL340 2 1/8" H	61	BS333/LS333 3/8" H	60	CP201 1 5/8"-7/8" M	55
BL340 2 1/8" XH	61	BS333/LS333 3/8" XH	60	CP201 1 5/8"-7/8" S	55
BL340 2 1/8"-1" H	60	BS333/LS333 5/16" H	60	CP201 1 7/8"-1 1/8" M	55
BL340 2 1/8"-1" XH	60	BS333/LS333 5/16" XH	60	CP201 1 7/8"-1 1/8" S	55
BL340 7/8" H	61	BS334/LS334 3/8" H	60	CP201 2 1/2"-1 1/2" M	55
BL340 7/8" XH	61	BS334/LS334 3/8" XH	60	CP201 2 1/2"-1 1/2" S	55
BL340 7/8"-3/8" H	60	BS334/LS334 5/16" H	60	CP201 2 1/4"-1 1/4" M	55
BL340 7/8"-3/8" XH	60	BS334/LS334 5/16" XH	60	CP201 2 1/4"-1 1/4" S	55
BL342 1 1/8"-1/2" H	60	BS337/FA337 3/8" MH	61	CP201 2 3/16"-1 3/16" M	55
BL342 1 1/8"-1/2" XH	60	BS337/FA337 3/8" XH	61	CP201 2 3/16"-1 3/16" S	55
BL342 1 3/8"-5/8" H	60	BS337/FA337 5/16" H	61	CP201 2 3/4"-1 3/4" M	55
BL342 1 3/8"-5/8" XH	60	BS337/FA337 5/16" M	61	CP201 2 3/4"-1 3/4" S	55
BL342 1 5/8"-3/4" H	60	C72 11/4RJ-RE	46	CP201 2 3/8"-1 3/8" M	55
BL342 1 5/8"-3/4" XH	60	CB501 1 1/2" M	58	CP201 2 3/8"-1 3/8" S	55
BL342 7/8"-3/8" H	60	CB501 1 1/4" M	58	CP201 2 5/8"-1 5/8" M	55
BL342 7/8"-3/8" XH	60	CB501 1" M	58	CP201 2 5/8"-1 5/8" S	55
BOM-100	10	CB501 1/2" M	58	CP201 3"-2" M	55
BOM-101(4)	10	CB501 1/4" M	58	CP203 1 1/2" M	56
BOM-80(4)	10	CB501 3/16" M	58	CP203 1 1/2" S	56
BOM-80(6)	10	CB501 3/4" M	58	CP203 1 1/4" M	56
BP206 1 1/2" M	56	CB501 3/8" M	58	CP203 1 1/4" S	56
BP206 1 1/2" S	56	CB501 5/16" M	58	CP203 1 1/8" M	56
BP206 1 1/4" M	56	CG-500(AJ)110V	107	CP203 1 1/8" S	56
BP206 1 1/4" S	56	CG-500(AJ)220V	107	CP203 1 3/16" M	56
BP206 1 1/8" M	56	CG-500(S)110V	107	CP203 1 3/16" S	56
BP206 1 1/8" S	56	CG-500(S)220V	107	CP203 1 3/4" M	56
BP206 1 3/16" M	56	CG-500(S+A)110V	107	CP203 1 3/4" S	56
BP206 1 3/16" S	56	CG-500(S+A)220V	107	CP203 1 3/8" M	56
BP206 1 3/8" M	56	CH141	12	CP203 1 3/8" S	56
BP206 1 3/8" S	56	CH502 1/4" S	58	CP203 1 5/8" M	56
BP206 1" M	56	CH502 1/4" S	58	CP203 1 5/8" S	56



CP203 1" M	56	CR 1/2E	90	D390	82
CP203 1" S	56	CR 1/32	90	D4206	82
CP203 7/8" M	56	CR 1/32E	90	D4207	82
CP203 7/8" S	56	CR 1/32N	90	D569	82
CP204 1 1/2" M	56	CR 1/32NK	90	D574	82
CP204 1 1/2" S	56	CR 1/32NS	90	D575	82
CP204 1 1/4" M	56	CR 1/4E	90	D579	82
CP204 1 1/4" S	56	CR 1/8E	90	D581	82
CP204 1 1/8" M	56	CR 3/16E	90	D582	82
CP204 1 1/8" S	56	CR 3/8E	90	DSK-25	26
CP204 1 3/16" M	56	CR 5/16E	90	DSK-27	26
CP204 1 3/16" S	56	CR26H	39	E14	71
CP204 1 3/8" M	56	CR26J	39	E16	71
CP204 1 3/8" S	56	CRL03	39	E18	71
CP204 1 5/8" M	56	CRL03H	40	E1826	68
CP204 1 5/8" S	56	CRL03J	40	E1827	68
CP204 1" M	56	CRL09J	40	E1828	68
CP204 1" S	56	CT164728	23	E20	71
CP527 1 1/2" H	58	CT210755	12	E22	71
CP527 1 1/2" M	58	CT270-112	22	E229	68
CP527 1 1/2" XH	58	CT270-113/1	22	E229	71
CP527 1 3/4" H	58	CT276B-112	22	E24	71
CP527 1 3/4" M	58	CT-277000	12	E3326	68
CP527 1 3/4" XH	58	CT277-112	22	E3327	68
CP527 1 5/8" H	58	CT277-113	22	E3524P	68
CP527 1 5/8" M	58	CT2777-112	22	E3826P	68
CP527 1 5/8" XH	58	CT2777-1121	22	E3827P	68
CP527 1 7/8" H	58	CT279-112	22	E4426P	68
CP527 1 7/8" M	58	CT279-113/1	22	E4427P	68
CP527 1 7/8" XH	58	CT290-112	22	E4826	68
CP527 2 1/2" H	58	CT290-113	22	E4827	68
CP527 2 1/2" M	58	CT290-113SP	22	E591B	68
CP527 2 1/2" XH	58	CT302865-0-11	22	E784	68
CP527 2 1/4" H	58	CT39549	24	E797	68
CP527 2 1/4" M	58	CT39549J	24	E800	68
CP527 2 1/4" XH	58	CT39570	25	E805	68
CP527 2 1/8" H	58	CT39570J	25	E809	68
CP527 2 1/8" M	58	D100	12	E810	68
CP527 2 1/8" XH	58	D1206	83	E839	68
CP527 2 3/8" H	58	D1207	82	E854	68
CP527 2 3/8" M	58	D1216	82	E868	68
CP527 2 3/8" XH	58	D2107	83	E870	68
CP527 2" H	58	D2402-555-BA0	36	E919	69
CP527 2" M	58	D2406-555-B00	36	E920	69
CP527 2" XH	58	D2406-555-DOH	36	E934	69
CR 1/16	90	D2423-141-EOO	36	E982	69
CR 1/16E	90	D2424-141-EOO	36	E986	69
CR 1/16N	90	D290	82	E988	69
CR 1/16NK	90	D3216	82	E989	69
CR 1/16NS	90	D3217	82	EB531 3/8"	57





EB531 1"	57	K710NA (A) 45-18	52	K712NA (B) 60-20	53
EB531 1/2"	57	K710NA (A) 48-19	52	K712NA (B) 65-22	53
EB531 1-1/8"	57	K710NA (A) 50-20	52	K712NA (B) 70-25	53
EB531 3/4"	57	K710NA (A) 55-22	52	K712NA (B) 75-28	53
EB531 5/8"	57	K710NA (A) 60-25	52	KG131-E	99
EG0204000000	41	K710NA (A) 65-28	52	KG142-E	99
FBQ30	40	K710NA (A) 70-30	52	KG153-E	99
FE40+FE16	87	K710NA (A) 75-32	52	KG155E-E	99
FE41	87	K710NA (A) 75-34	52	KL25	97
FR134	40	K710NA (A) 85-32	52	KL35A	97
FR34	40	K710NA (B) 25-6	52	KM EU 100	107
FR34B	40	K710NA (B) 30-8	52	KR-23	23
FR40	40	K710NA (B) 35-10	52	KR-23A	23
FR40D	40	K710NA (B) 40-12	52	KR-23C	23
FR40J	40	K710NA (B) 40-13	52	KR-35	23
FX0227000000	41	K710NA (B) 45-14	52	KR-35C	23
FX0228000000	41	K710NA (B) 50-16	52	KRH-10	10
GRINDING STONE	108	K710NA (B) 55-18	52	KRH-12	10
GS-181C2-1	107	K710NA (B) 60-20	52	KRH-12(4)	10
GS-181C2-2	107	K710NA (B) 65-22	52	KRH-15	10
GS-181C2-5	107	K710NA (B) 70-25	52	KRH-20	10
H1258	83	K710NA (B) 75-28	52	KS-24	40
H1259	82	K710NA (B) 80-30	52	LEATHER-SKIVING	106
H1262	82	K710NA (B) 85-34	52	LO515 1" M	59
H1359	82	K712NA (A) 20-6	53	LO515 1/2" M	59
H26	71	K712NA (A) 25-8	53	LO515 3/4" M	59
H3159	83	K712NA (A) 30-10	53	LO516 1 1/4"-5/16" M	58
H3362	82	K712NA (A) 32-12	53	LO516 1 3/8"-3/8" M	58
H3363	82	K712NA (A) 35-13	53	LO516 1"-1/4" M	58
H4258	82	K712NA (A) 38-14	53	LO516 3/4"-3/16" M	58
H4259	82	K712NA (A) 40-15	53	LO535 5/8" M	59
H442	82	K712NA (A) 40-16	53	LO535 5/8" S	59
H445	82	K712NA (A) 42-17	53	LO535 1 1/4" M	59
H492	82	K712NA (A) 45-18	53	LO535 1 1/4" S	59
H494	83	K712NA (A) 48-19	53	LO535 1 3/4" M	59
H497	83	K712NA (A) 50-20	53	LO535 1 3/4" S	59
H500	83	K712NA (A) 55-22	53	LO535 1 3/8" M	59
H501	83	K712NA (A) 60-25	53	LO535 1 3/8" S	59
H974	83	K712NA (A) 65-28	53	LO535 1" M	59
HOOG'S (R)	9	K712NA (A) 70-30	53	LO535 1" S	59
HOOG'S 110m/m	9	K712NA (A) 75-32	53	LO535 7/8" M	59
K710NA (A) 20-6	52	K712NA (A) 75-34	53	LO535 7/8" S	59
K710NA (A) 25-8	52	K712NA (B) 25-6	53	LP26	97
K710NA (A) 30-10	52	K712NA (B) 30-8	53	LU02	32
K710NA (A) 32-12	52	K712NA (B) 35-10	53	LU05	40
K710NA (A) 35-13	52	K712NA (B) 40-12	53	LU101	40
K710NA (A) 38-14	52	K712NA (B) 40-13	53	LU103	40
K710NA (A) 40-15	52	K712NA (B) 45-14	53	LU501	40
K710NA (A) 40-16	52	K712NA (B) 50-16	53	LU503	40
K710NA (A) 42-17	52	K712NA (B) 55-18	53	LU602	40



LU605	40	NR-31S	91	P818	91
M-086 10" SLIDER-HSS	3	P127	93	P818L	91
M-086 13" SLIDER-HSS	3	P193	93	P946	93
M-086 5" SLIDER-HSS	3	P253E-4	89	PINKING SHEAR	104
M-086 6" SLIDER-HSS	3	P301	93	PL-Q11-01B	14
M-086 7" SLIDER-HSS	3	P301C 1/4	92	PUP	11
M-086 8" SLIDER-HSS	3	P301C 1/8	92	R-58	109
M-086 9" SLIDER-HSS	3	P301C 3/16	92	R 10W	11
M4240	99	P301N	93	R 1512	12
M4356	99	P31	93	R 1513	12
M4364	99	P311N	93	R 1514	12
M688Z	109	P31C 1/4	92	R 1515	12
M700(6)	12	P31C 1/8	92	R 2 1/2H	9
M702	12	P31C 3/16	92	R 2 1/2M	10
M703(8)	12	P351	93	R 2 1/2W	11
M740(8)	12	P360	93	R 2(8)KURIS	10
M741(8)	12	P361	93	R 2@KURIS	10
M742	12	P363	93	R 28X0.3	12
MAS-11012000	36	P363V	93	R 28X0.3	12
MAS-11013000	36	P36L	93	R 2KM	9
MAS-11016000	36	P36LN	93	R 2KM(7)	9
MAS-11017000	36	P36LW	93	R 2KM(7)-HSS	9
ME28	97	P36N	93	R 2W	11
MF00A0834	37	P502-A	89	R 3 1/2H	9
MF00A0838	37	P58N	93	R 3 1/2H-HSS	9
MF02A0834	37	P69D 1/4	91	R 4 1/4	12
MF40A1834	37	P69D 1/8	91	R 4 1/4	12
MF40A1835	37	P69D 3/16	91	R 4 3/4W#22	11
MF40A2835	37	P69L 1/2	91	R 45X0.3	12
ML-110-1	11	P69L 1/4	91	R 45X0.3	12
ML-113	11	P69L 1/8	91	R 4E	8
MS03A0838	37	P69L 3/8	91	R 4E#141	8
MS-55(7)	9	P810	91	R 4KM	9
MT01	97	P810L	91	R 4KM(8)	9
NL-31S	91	P811	91	R 4M	10
NO.02 1/8	89	P8115	91	R 4W	11
NO.04 3/16	89	P8115L	91	R 5 1/4E	8
NO.06 1/4	89	P811L	91	R 5 1/4M	10
NO.07 5/16	89	P812	91	R 5 1/4M59	10
NO.09 3/8	89	P8125	91	R 5 1/4W#21	11
NO.095 7/16	89	P8125L	91	R 5 1/4W#24	11
NO.1 1/16	89	P812L	91	R 5E	8
NO.1 1/2 5/64	89	P813	91	R 5H	9
NO.2 3/32	89	P813L	91	R 5KM-HSS	9
NO.2 1/2 1/8	89	P814	91	R 5M	10
NO.3 5/32	89	P814L	91	R 6B	8
NO.4 3/16	89	P815	91	R 6E	8
NO.5 7/32	89	P815L	91	R 6KM-HSS	9
NO.6 1/4	89	P816	91	R 6M	11
NO.7 1/2 5/16	89	P816L	91	R 6W NO.16	11



R 6W NO.18	11	RS219 2 1/2" M	57	S123 (A) 25-8	52
R 7 1/2E	8	RS219 2 1/2" MH	57	S123 (A) 30-10	52
R 7E	8	RS219 2 1/4" M	57	S123 (A) 32-12	52
R 7M	11	RS219 2 1/4" MH	57	S123 (A) 35-13	52
R 7W	11	RS219 2 3/4" M	57	S123 (A) 38-14	52
R 80X40X1.0	12	RS219 2 3/4" MH	57	S123 (A) 40-15	52
R 80X40X1.0-ALLOY	12	RS219 2" M	57	S123 (A) 40-16	52
R 80X40X1.0-S- ALLOY	12	RS219 2" MH	57	S123 (A) 42-17	52
R 8W	11	RS-232	10	S123 (A) 45-18	52
R101E08 #120 GREY	109	RS-50	9	S123 (A) 48-19	52
R101J03 #180 GREEN	109	RS-50(7)	9	S123 (A) 50-20	52
R101W05 #220 WHITE	109	RS-50(7)-HSS	9	S123 (A) 55-22	52
R110-90	9	RS-50-CT	27	S123 (A) 60-25	52
R2-5/16B(10)	8	S02374-001	30	S123 (A) 65-28	52
R2E	92	S02375-001	30	S123 (A) 70-30	52
R4 1/4-CT	27	S02637-001	30	S123 (A) 75-32	52
R4 1/4-CT(2)	27	S02643-001	30	S123 (A) 75-34	52
R4 1/4-CT(2-2)	27	S02645-001	30	S123 (A) 85-32	52
R41/4-SKS2	12	S02646-001	30	S123 (B) 25-6	52
R4200-HOD-DOO	64	S03536-001	96	S123 (B) 30-8	52
R4200-JOE-DOO	64	S03627-001	30	S123 (B) 35-10	52
R4205-HOD-EAO	64	S03629-001	30	S123 (B) 40-12	52
R4305-HOD-EOO	64	S07526-001	30	S123 (B) 40-13	52
R4305-J6E-EOO	64	S07526-201	30	S123 (B) 45-14	52
R4305-JOE-EOO	64	S07527-001	30	S123 (B) 50-16	52
R4508-HOD-DOO	64	S08302-001	30	S123 (B) 55-18	52
R4508-JOE-DOO	64	S08322-001	30	S123 (B) 60-20	52
R4608-JOE-DOO	64	S08711-001	100	S123 (B) 65-22	52
R4612-HOF-GOO	64	S08713-001	100	S123 (B) 70-25	52
R4612-JOD-E01	64	S08723-001	63	S123 (B) 75-28	52
R4612-JOF-DOO	64	S08724-001	63	S123 (B) 80-30	52
R5 1/4B	8	S08731-001	63	S123 (B) 85-34	52
R5 1/4B55	8	S08732-001	63	S124 (A) 20-6	53
R501-140/1-MS21	9	S08882-001	74	S124 (A) 25-8	53
RCS-135(8)	9	S08883-001	74	S124 (A) 30-10	53
RE-12	9	S08885-001	80	S124 (A) 32-12	53
RE-12-HSS	9	S08886-001	80	S124 (A) 35-13	53
RL-SL-261416	27	S09075-001	30	S124 (A) 38-14	53
ROBO GRIP-7 Inch	107	S09093-001	30	S124 (A) 40-15	53
RS-100	9	S09094-001	30	S124 (A) 40-16	53
RS-100(8)-ALLOY	9	S09101-001	30	S124 (A) 42-17	53
RS-100(8)-HSS	9	S10205-101	30	S124 (A) 45-18	53
RS219 1 1/2" M	57	S10210-101	30	S124 (A) 48-19	53
RS219 1 1/2" MH	57	S10210-101	30	S124 (A) 50-20	53
RS219 1 1/4" M	57	S10210-201	30	S124 (A) 55-22	53
RS219 1 1/4" MH	57	S10570-001 1/8	47	S124 (A) 60-25	53
RS219 1 1/8" M	57	S10572-001 3/16	47	S124 (A) 65-28	53
RS219 1 1/8" MH	57	S10573-001 1/4	47	S124 (A) 70-30	53
RS219 1" M	57	S10605-001	47	S124 (A) 75-32	53
RS219 1" MH	57	S123 (A) 20-6	52	S124 (A) 75-34	53



S124 (B) 25-6	53	S20582-001	8	S50265-001	31
S124 (B) 30-8	53	S20583-001	8	S50270-000	31
S124 (B) 35-10	53	S20626-001	96	S50404-101	31
S124 (B) 40-12	53	S20896-101	8	S510	94
S124 (B) 40-13	53	S20896-101	8	S518L	93
S124 (B) 45-14	53	S20897-101	8	S518L	93
S124 (B) 50-16	53	S20898-101	8	S518N	93
S124 (B) 55-18	53	S20899-001	8	S518N	93
S124 (B) 60-20	53	S21104-001	100	S518NS	93
S124 (B) 65-22	53	S25190-001	63	S518NS	93
S124 (B) 70-25	53	S28348-001	31	S524	92
S124 (B) 75-28	53	S28352-001	31	S534	92
S150	109	S28650-201	31	S543	91
S16248-001	30	S28654-001	31	S544	91
S19145-001	63	S34895-001	31	S56370-001	31
S19146-001	63	S34899-001	31	S56917-001	32
S19154-001	63	S35029-001	31	S60 16 mm	49
S19155-001	63	S35437-101	31	S60 18 mm	49
S19162-001	63	S356N 1	46	S60 20 mm	49
S19166-001	63	S356N 1 1/4	46	S60 22 mm	49
S19169-001	63	S356N 1 1/8	46	S60 24 mm	49
S19185-001	63	S356N 1 3/8	46	S60 26 mm	49
S19186-001	63	S356N 1/2	46	S60 28 mm	49
S19199-001	74	S356N 1/4	46	S60 30 mm	49
S19202-001	74	S356N 1/8	46	S60 32 mm	49
S19212-001	74	S356N 11/16	46	S60 34 mm	49
S19217-001	74	S356N 3/4	46	S60 36 mm	49
S19219-001	74	S356N 3/8	46	S60 38 mm	49
S19228-101	74	S356N 5/16	46	S60 40 mm	49
S19236-001	74	S356N 5/8	46	S60 45 mm	49
S19237-001	74	S356N 7/16	46	S60 50 mm	49
S19240-001	74	S356N 7/8	46	S6-91-H	11
S19244-001	74	S356N 9/16	46	S6-91-K	11
S19247-001	74	S37671-101	31	S75D 1/2"	50
S19280-001	89	S37672-101	31	S75D 1/4"	50
S19313-201	89	S37675-101	31	S75D 3/8"	50
S19317-001	89	S37676-101	31	S75U 1/2"	51
S19334-001	89	S37723-001	31	S75U 1/4"	51
S19824-001	30	S400 1/16"	51	S75U 3/8"	51
S20118-001	31	S400 1/2"	51	SA3330-001	32
S20232-001	63	S400 1/4"	51	SA3335-001	32
S20234-001	63	S400 1/8"	51	SA3656-101	32
S20236-001	63	S400 3/16"	51	SA3658-001	32
S20239-101	74	S400 3/8"	51	SA6596-001	32
S20241-101	74	S49988-001	31	SA6597-001	32
S20245-001	74	S50113-101	31	SA6988-001	32
S20398-001	100	S50258-101	31	SA6989-001	32
S20404-001	100	S50259-101	31	SB1189-001	32
S20406-001	100	S50260-101	31	SB1191-101	32
S20579-101	8	S50263-001	31	SKIVING BELL KNIVES	106





SM20 1/32	94	WB301 3 1/4"-1 1/4" XH	54	WB307 2 3/8"-1 5/8" XH	54
SP18 1/16	92	WB301 3 1/8"-1 3/16" H	54	WB307 2 5/8"-1 7/8" H	54
SP18 1/32	92	WB301 3 1/8"-1 3/16" XH	54	WB307 2 5/8"-1 7/8" XH	54
SP18 1/4	92	WB301 3 3/4"-1 1/2" H	54	WB307 2"-1 1/4" H	54
SP18 1/8	92	WB301 3 3/4"-1 1/2" XH	54	WB307 2"-1 1/4" XH	54
SP18 3/16	92	WB301 3"- 1 1/8" H	54	WB308 2 1/2"-1 1/2" H	55
SP18 5/16	92	WB301 3"- 1 1/8" XH	54	WB308 2 1/2"-1 1/2" XH	55
SP18L 1/16	92	WB301 4 1/2"-1 7/8" H	54	WB308 2 1/4"-1 1/4" H	55
SP18L 1/32	92	WB301 4 1/2"-1 7/8" XH	54	WB308 2 1/4"-1 1/4" XH	55
SP18L 1/4	92	WB301 4 1/4"-1 3/4" H	54	WB308 2 3/4"-1 3/4" H	55
SP18L 1/8	92	WB301 4 1/4"-1 3/4" XH	54	WB308 2 3/4"-1 3/4" XH	55
SP18L 5/16	92	WB301 4 3/4"-2" H	54	WB308 2 3/8"-1 3/8" H	55
SP18L 3/16	92	WB301 4 3/4"-2" XH	54	WB308 2 3/8"-1 3/8" XH	55
SPK3	92	WB301 4"-1 5/8" H	54	WB308 2 5/8"-1 5/8" H	55
ST211 3/8" M	57	WB301 4"-1 5/8" XH	54	WB308 2 5/8"-1 5/8" XH	55
ST211 3/8" S	57	WB302 2 3/4"-1" H	54	WB309 1 15/16"-1 3/16" H	55
SW75D 1/2"	51	WB302 2 3/4"-1" XH	54	WB309 1 15/16"-1 3/16" XH	55
SW75D 1/4"	51	WB302 3 1/2"-1 3/8" H	54	WB309 1 3/4"-1" H	55
SW75D 3/8"	51	WB302 3 1/2"-1 3/8" XH	54	WB309 1 3/4"-1" XH	55
SW75U 1/2"	54	WB302 3 1/4"-1 1/4" H	54	WB309 1 7/8"-1 1/8" H	55
SW75U 1/4"	54	WB302 3 1/4"-1 1/4" XH	54	WB309 1 7/8"-1 1/8" XH	55
SW75U 3/8"	54	WB302 3 1/8"-1 3/16" H	54	WB309 2 1/2"-1 3/4" H	55
T-50	109	WB302 3 1/8"-1 3/16" XH	54	WB309 2 1/2"-1 3/4" XH	55
T-80	109	WB302 3 3/4"-1 1/2" H	54	WB309 2 1/4"-1 1/2" H	55
TAGGING GUN	105	WB302 3 3/4"-1 1/2" XH	54	WB309 2 1/4"-1 1/2" XH	55
TAILOR SHEAR	104	WB302 3"- 1 1/8" H	54	WB309 2 1/8"-1 3/8" H	55
TC-100	103	WB302 3"- 1 1/8" XH	54	WB309 2 1/8"-1 3/8" XH	55
TC-230	104	WB302 4 1/2"-1 7/8" H	54	WB309 2 3/4"-2" H	55
TC-801	103	WB302 4 1/2"-1 7/8" XH	54	WB309 2 3/4"-2" XH	55
TC-805	103	WB302 4 1/4"-1 3/4" H	54	WB309 2 3/8"-1 5/8" H	55
TC-805B	103	WB302 4 1/4"-1 3/4" XH	54	WB309 2 3/8"-1 5/8" XH	55
TC-805BS	103	WB302 4 3/4"-2" H	54	WB309 2 5/8"-1 7/8" H	55
TC-RG	103	WB302 4 3/4"-2" XH	54	WB309 2 5/8"-1 7/8" XH	55
TC-W220	104	WB302 4"-1 5/8" H	54	WB309 2"-1 1/4" H	55
TC-W240	104	WB302 4"-1 5/8" XH	54	WB309 2"-1 1/4" XH	55
TC-W260	104	WB307 1 15/16"-1 3/16" H	54	WB313 1 15/16"-1 3/16" H	55
TC-W280	104	WB307 1 15/16"-1 3/16" XH	54	WB313 1 15/16"-1 3/16" XH	55
TC-W300	104	WB307 1 3/4"-1" H	54	WB313 1 3/4"-1" H	55
TG-88S-O	105	WB307 1 3/4"-1" XH	54	WB313 1 3/4"-1" XH	55
TG-88S-P	105	WB307 1 7/8"-1 1/8" H	54	WB313 1 7/8"-1 1/8" H	55
THREAD CLIPPERS	103	WB307 1 7/8"-1 1/8" XH	54	WB313 1 7/8"-1 1/8" XH	55
THREAD-260	32	WB307 2 1/2"-1 3/4" H	54	WB313 2 1/2"-1 1/2" H	55
THREAD-755	32	WB307 2 1/2"-1 3/4" XH	54	WB313 2 1/2"-1 1/2" XH	55
UT506	40	WB307 2 1/4"-1 1/2" H	54	WB313 2 1/4"-1 1/4" H	55
UT507	40	WB307 2 1/4"-1 1/2" XH	54	WB313 2 1/4"-1 1/4" XH	55
WB301 2 3/4"-1" H	54	WB307 2 1/8"-1 3/8" H	54	WB313 2 3/4"- 1 3/4" H	55
WB301 2 3/4"-1" XH	54	WB307 2 1/8"-1 3/8" XH	54	WB313 2 3/4"- 1 3/4" XH	55
WB301 3 1/2"-1 3/8" H	54	WB307 2 3/4"-2" H	54	WB313 2 3/8"-1 3/8" H	55
WB301 3 1/2"-1 3/8" XH	54	WB307 2 3/4"-2" XH	54	WB313 2 3/8"-1 3/8" XH	55
WB301 3 1/4"-1 1/4" H	54	WB307 2 3/8"-1 5/8" H	54	WB313 2 5/8"- 1 5/8" H	55



We are **SEWING**
Since 1978



WB313 2 5/8"- 1 5/8" XH	55
WB313 2 7/8"-1 7/8" H	55
WB313 2 7/8"-1 7/8" XH	55
WB313 3"-2" H	55
WB313 3"-2" XH	55
X05007001	8
X05007001	27
37919	107
990474-0-10	107
TC-808SB	104
TC-S230	105

