

---

**PFAFF**<sup>®</sup>

**145**

**Unterklassen-Ausstattung**  
Subclass parts  
Composition des sous-classes  
Composición de las subclases

Unterklassen-Ausstattung<sup>1)</sup>

Subclass Organization<sup>1)</sup>

Equipement des sous-classes<sup>1)</sup>

Dotación de las subclases<sup>1)</sup>

Unterklasse Subclass Sous-classe Subclase	Ausführung Model Version Tipo de máquina	Nadelstange Needle bar Barre à aiguille Barra de aguja	Stoffschieber <sup>1)</sup> Feed dog Griffe Transportador inferior	Stichplatte <sup>1)</sup> Needle plate Plaque à aiguille Placa de aguja	Nähfuß <sup>1)</sup> Presser foot Pied presseur Pie prensateelas	Stoffschieberfuß <sup>1)</sup> Vibrating presser Pied entraîneur Transportador superior
-2/01**	B, BN	91-710 650-92	91-040 444-04 <sup>1272</sup>	91-040 445-04 <sup>1272</sup>	91-040 234-04 <sup>1272</sup>	91-040 233-93 <sup>1272</sup>
<sup>12)</sup> = 1,8–4,0 mm						
-6/01*	B, BN	91-710 650-92	91-026 745-04	91-026 746-04	91-040 475-04 <sup>1272</sup>	91-040 474-93 <sup>1272</sup>
-17/01	B, BN	91-710 650-92	91-045 591-04	91-045 592-04	91-040 432-04 <sup>1272</sup>	91-042 819-93 <sup>1272</sup>
-17/41	B, BN	91-710 650-92	91-040 897-04	91-040 898-04	91-040 475-04 <sup>1272</sup>	91-040 474-93 <sup>1272</sup>
-17/43*	B, BN	91-710 650-92	91-026 745-04	91-026 746-04	91-049 514-04 <sup>5)</sup>	91-049 021-93 <sup>5)</sup>
-19/01*	B, BN	91-710 650-92	91-026 745-04	91-026 746-04	91-040 475-04 <sup>1272</sup>	91-040 474-93 <sup>1272</sup>
-19/02*	B, BN	91-710 650-92	91-026 745-04	91-026 746-04	91-040 475-04 <sup>1272</sup>	91-040 474-93 <sup>1272</sup>
-39/01	B, BN	91-710 650-92	91-045 591-04	91-045 592-04	91-040 432-04 <sup>1272</sup>	91-042 819-93 <sup>1272</sup>
-39/21	B, BN	91-710 650-92	91-045 591-04	91-045 592-04	91-044 227-04 <sup>1272</sup>	91-042 819-93 <sup>1272</sup>
-39/22	B, BN	91-710 650-92	91-045 591-04	91-045 592-04	91-044 227-04 <sup>1272</sup>	91-042 819-93 <sup>1272</sup>
-39/41	B, BN	91-710 650-92	91-040 897-04	91-040 898-04	91-040 475-04 <sup>1272</sup>	91-040 474-93 <sup>1272</sup>
-39/81	B	91-710 650-92	91-047 399-04	91-048 924-04	91-040 432-04 <sup>1272</sup>	91-042 819-93 <sup>1272</sup>
-40/11**	B, BN	91-710 650-92	91-040 444-04 <sup>1272</sup>	91-040 445-04 <sup>1272</sup>	91-044 227-04 <sup>1272</sup>	91-042 819-93 <sup>1272</sup>
-40/41*	B, BN	91-710 650-92	91-026 745-04	91-026 746-04	91-040 475-04 <sup>1272</sup>	91-040 474-93 <sup>1272</sup>
-40/61**	B, BN	91-710 650-92	91-040 444-04 <sup>1272</sup>	91-040 445-04 <sup>1272</sup>	91-044 227-04 <sup>1272</sup>	91-042 819-93 <sup>1272</sup>
-42/02*	B, BN	91-710 650-92	91-026 745-04	91-026 746-04	91-046 342-04 <sup>1272</sup>	91-040 461-93 <sup>1272</sup>
-95/04	B, BN	91-710 650-92	91-045 591-04	91-045 592-04	91-044 227-04 <sup>1272</sup>	91-042 819-93 <sup>1272</sup>
-136/02*	B, BN	91-710 650-92	91-026 745-04	91-026 746-04	91-049 514-04 <sup>5)</sup>	91-049 021-93 <sup>5)</sup>
-155/01	B, BN	91-710 650-92	91-045 591-04	91-045 592-04	91-040 432-04 <sup>1272</sup>	91-042 819-93 <sup>1272</sup>
-155/21	B, BN	91-710 650-92	91-045 591-04	91-048 360-04	91-044 227-04 <sup>1272</sup>	91-042 819-93 <sup>1272</sup>
-155/41	B, BN	91-710 650-92	91-040 897-04	91-040 898-04	91-040 475-04 <sup>1272</sup>	91-040 474-93 <sup>1272</sup>
-167/02*	B, BN	91-710 650-92	91-026 745-04	91-026 746-04	91-040 475-04 <sup>1272</sup>	91-040 474-93 <sup>1272</sup>
-168/02*	B, BN	91-710 650-92	91-026 745-04	91-026 746-04	91-042 180-04 <sup>5)</sup>	91-042 181-93 <sup>5)</sup>
-195/02*	B, BN	91-710 650-92	91-026 745-04	91-026 746-04	91-040 475-04 <sup>1272</sup>	91-040 474-93 <sup>1272</sup>
-195/04	B, BN	91-710 650-92	91-045 591-04	91-045 592-04	91-044 227-04 <sup>1272</sup>	91-042 819-93 <sup>1272</sup>
-226/02*	B, BN	91-710 650-92	91-026 745-04	91-026 746-04	91-046 719-04 <sup>5)</sup>	91-046 720-93 <sup>5)</sup>
-248/02*	B, BN	91-710 650-92	91-026 745-04	91-026 746-04	91-046 656-04	91-046 657-93

\* Unterklasse kann mit Fadendurchzieh- und Fadenabschneid-Einrichtung -900/11;/16;/51;/56 geliefert werden, wobei sich die Nummer des Stoffschiebers von 91-026 745-04 in 91-047 822-04 und die Nummer der Stichplatte bei -900/11 und /51 von 91-026 746-04 in 91-058 420-05 bzw. bei -900/16 und /56 von 91-026 746-04 in 91-058 939-05 ändert.

\* Subclass can be supplied with thread puller/trimmer -900/11;/16;/51;/56, in which case feed dog No. 91-026 745-04 is replaced by No. 91-047 822-04, and with -900/11 and /51 needle plate No. 91-026 746-04 is replaced by No. 91-058 420-05, and with -900/16 and /56 needle plate No. 91-026 746-04 is replaced by No. 91-058 939-05.

\*\* Unterklasse kann mit Fadendurchzieh- und Fadenabschneid-Einrichtung -900/11 und /51 geliefert werden, wobei sich die Nummer der Stichplatte von 91-040 445 in 91-058 422-04 ändert.

\*\* Subclass can be supplied with thread puller/trimmer -900/11 and /51, in which case needle plate No. 91-040 445-04 is replaced by No. 91-058 422-04.

<sup>1)</sup> = Ausführung angeben  
= Indicate model  
= Préciser la version  
= Indicar el tipo de máquina

<sup>5)</sup> = Nähmuster einsenden  
= Submit sewing sample  
= Joindre échantillons de couture  
= Enviar muestra de costura

<sup>12)</sup> = Absteppbreite angeben  
= Indicate stitching margin  
= Indiquer le relarge de couture  
= Indiquese el margen de costura

<sup>1272</sup> = Absteppbreite bei Bestellung angeben  
= Indicate stitching margin on order  
= Indiquer le relarge de couture à la commande  
= Indiquese el margen de costura en los pedidos

**Equipement des sous-classes<sup>1)</sup>**  
**Unterklassen-Ausstattung<sup>1)</sup>**

**Dotación de las subclases<sup>1)</sup>**  
**Subclass organization<sup>1)</sup>**

Sous-classe Subclase	Ausführung Modell Version Tipo de máquina	Apparat [S] Attachment Appareil Aparato	Träger Bracket Support Soporte	Halterwinkel Bracket Equerre de retenue Soporte angular	Kopfplatte Face plate Plaque frontale Placa frontal	Lineal Edge guide Guide-droit Guia recta	Bandhalter Tape edge Plaque dérouleur Disco portachitas	Bandrollhalter Tape reel bracket Support de plateau dérouleur Portarrollos	Fingerschutz Finger guard Protège-digits Salvadedos
01**	B, BN			91-025 559-25		91-040 998-25			91-055 203-5
= 1,8-4,0 mm									
01*	B, BN								91-055 203-5
7/01	B, BN	91-040 533-23	91-045 607-90				91-043 943-91		91-055 203-5
7/41	B, BN	91-041 111-23	91-040 528-90				91-043 943-91		91-055 203-5
7/43*	B, BN	91-053 132-25	91-040 528-90						91-055 203-5
7/01*	B, BN	91-041 006-23	91-040 528-90						91-055 203-5
9/02*	B, BN	91-044 408-23	91-040 528-90						91-055 203-5
9/01	B, BN	91-041 969-25	91-045 607-90				91-043 943-91		91-055 203-5
9/21	B, BN	91-041 382-23	91-045 607-90				91-043 943-91		91-055 203-5
9/22	B, BN	91-046 265-25	91-045 607-90				91-043 943-91		91-055 203-5
9/41	B, BN	91-041 113-23	91-040 528-90				91-043 943-91		91-055 203-5
9/81	B	91-053 674-23	91-040 528-90				91-043 943-91		91-055 203-5
0/11**	B, BN	91-053 676-25	91-042 940-90 ○⊗						91-055 203-5
0/41*	B, BN	91-053 257-93	91-042 940-90 ○⊗						91-055 203-5
0/61**	B, BN	91-046 331-24	91-042 940-90 ○⊗						91-055 203-5
2/02*	B, BN	91-040 638-23	91-040 528-90						91-055 203-5
5/04	B, BN	91-041 959-23	91-045 607-90						91-055 203-5
36/02*	B, BN	91-053 078-23	91-040 528-90						91-055 203-5
55/01	B, BN	91-040 600-23	91-045 607-90				91-043 943-91		91-055 203-5
55/21	B, BN	91-043 921-24	91-045 607-90				91-043 943-91		91-055 203-5
55/41	B, BN	91-041 112-23	91-040 528-90				91-043 943-91		91-055 203-5
67/02*	B, BN	91-042 099-23	91-040 528-90						91-055 203-5
68/02*	B, BN	91-042 179-23	91-040 528-90						91-055 203-5
95/02*	B, BN	91-040 798-23	91-040 528-90						91-055 203-5
95/04	B, BN	91-041 991-25	91-045 607-90						91-055 203-5
26/02*	B, BN	91-046 721-25	91-040 862-90		91-010 702-91			91-043 938-91	91-055 203-5
48/02*	B, BN	91-046 653-21	91-042 940-90 ○⊗						91-055 203-5

\* Sous-classe livrable avec coupe-fil -900/11;/16;/51 ou /56, avec remplacement de la griffe n° 91-026 745-04 par celle n° 91-047 822-04 et de la plaque à aiguille, en ss-cl. -900/11 et /51, n° 91-026 746-04 par celle, n° 91-058 420-05, respect., en ss-cl. -900/16 et /56, n° 91-026 746-04 par celle, n° 91-058 939-05.

\* La subclase puede suministrarse con cortahilos -900/11;/16;/51;/56 en cuyo caso se sustituye el transportador inferior N° 91-026 745-04 por el del N° 91-047 822-04 y la placa de aguja, en -900/11 y /51, N° 91-026 746-04 por la del N° 91-058 420-05, y en -900/16 y /56, el N° 91-026 746-04 se sustituye por el 91-058 939-05.

\*\* Sous-classe livrable avec coupe-fil -900/11 ou /51, avec remplacement de la plaque à aiguille n° 91-040 445-04 par celle, n° 91-058 422-04.

\*\* La subclase puede suministrarse con cortahilos -900/11 y /51, en cuyo caso la placa de aguja N° 91-040 445-04 se sustituye por la del N° 91-058 422-04.

91-710 650-92



- 2/01
- 2/01-900/11; /51
- 6/01
- 6/01-900/..
- 17/01
- 17/41
- 17/43
- 17/43-900/..
- 19/01
- 19/01-900/..
- 19/02
- 19/02-900/..
- 39/01
- 39/21
- 39/22
- 39/41
- 39/81
- 40/11
- 40/11-900/11; 51
- 40/41
- 40/41-900/..
- 40/61
- 40/61-900/11; /51
- 42/02
- 42/02-900/..
- 95/04
- 136/02
- 136/02-900/..
- 155/01
- 155/21
- 155/41
- 167/02
- 167/02-900/..
- 168/02
- 168/02-900/..
- 195/02
- 195/02-900/..
- 195/04
- 226/02
- 226/02-900/..
- 248/02
- 248/02-900/..

91-026 745-04 ☐

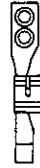

- 6/01
- 17/43
- 19/01
- 19/02
- 40/41
- 42/02
- 136/02
- 167/02
- 168/02
- 195/02
- 226/02
- 248/02

91-040 444-04 ☐ 12/2

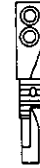

- 2/01
- 2/01-900/11; /51
- 40/11
- 40/11-900/11; /51
- 40/61
- 40/61-900/11; /51

91-040 897-04 ☐

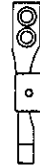

- 17/41
- 39/41
- 155/41

91-045 591-04 ☐ 12/2

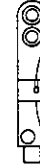

- 17/01
- 39/01
- 39/21
- 39/22
- 95/04
- 155/01
- 155/21
- 195/04

91-047 399-04 ☐

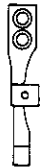

-39/81

91-047 822-04 ☐



- 6/01-900/..
- 17/43-900/..
- 19/01-900/..
- 19/02-900/..
- 40/41-900/..
- 42/02-900/..
- 136/02-900/..
- 167/02-900/..
- 168/02-900/..
- 195/02-900/..
- 226/02-900/..
- 248/02-900/..

91-026 746-04 ☐



- 6/01
- 17/43
- 19/01
- 19/02
- 40/41
- 42/02
- 136/02
- 167/02
- 168/02
- 195/02
- 226/02
- 248/02

91-040 445-04 ☐ 12/2



- 2/01
- 40/11
- 40/61

91-040 898-04 ☐



- 17/41
- 39/41
- 155/41

91-045 592-04 ☐



- 17/01
- 39/01
- 39/21
- 39/22
- 95/04
- 155/01
- 195/04

91-048 360-04 ☐



-155/21

91-048 924-04 ☐



-39/81

91-058 420-05



- 6/01-900/11; /51
- 17/43-900/11; /51
- 19/01-900/11; /51
- 19/02-900/11; /51
- 40/41-900/11; /51
- 42/02-900/11; /51
- 136/02-900/11; /51
- 167/02-900/11; /51
- 168/02-900/11; /51
- 195/02-900/11; /51
- 226/02-900/11; /51
- 248/02-900/11; /51

91-058 422-04 ☐



- 2/01-900/11; /51
- 40/11-900/11; /51
- 40/61-900/11; /51

91-058 939-05







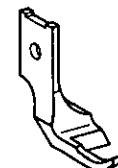







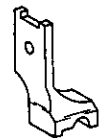

- 6/01-900/16; /56
- 17/43-900/16; /56
- 19/01-900/16; /56
- 19/02-900/16; /56
- 40/41-900/16; /56
- 42/02-900/16; /56
- 136/02-900/16; /56
- 167/02-900/16; /56
- 168/02-900/16; /56
- 195/02-900/16; /56
- 226/02-900/16; /56
- 248/02-900/16; /56

91-040 234-04 ☐ 12/2

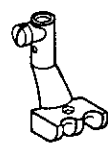

- 2/01
- 2/01-900/11; /51

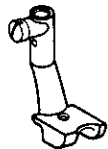
Unterklassen-Übersicht/Table of subclasses/Table des sous-classes/Tabla de subclasses

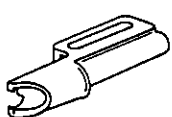
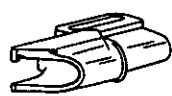
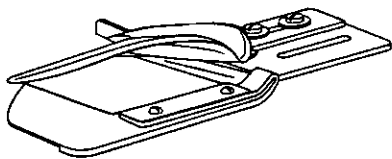
<p>91-040 432-04   </p>  <p>-17/01 -39/01 -39/81 -155/01</p>	<p>91-040 475-04   </p>  <p>-6/01 -40/41 -17/41 -40/41-900/.. -19/01 -155/41 -19/01-900/.. -167/02 -19/02 -167/02-900/.. -19/02-900/.. -195/02 -39/41 -195/02-900/..</p>	<p>91-042 180-04   </p>  <p>-168/02 -168/02-900/..</p>	<p>91-044 227-04   </p>  <p>-39/21 -40/61 -39/22 -40/61-900/11;/51 -40/11 -95/04 -40/11 -155/21 -900/11;/51 -195/04</p>
<p>91-046 342-04   </p>  <p>-42/02 -42/02-900/..</p>	<p>91-046 656-04   </p>  <p>-248/02 -248/02-900/..</p>	<p>91-046 719-04   </p>  <p>-226/02 -226/02-900/..</p>	<p>91-049 514-04   </p>  <p>-17/43 -17/43-900/.. -136/02 -136/02-900/..</p>
<p>91-040 233-93   </p>  <p>-2/01 -2/01-900/11;/51</p>	<p>91-040 461-93   </p>  <p>-42/02 -42/02-900/..</p>	<p>91-040 474-93   </p>  <p>-19/01-900/.. -19/02 -19/02-900/.. -39/41 -40/41 -40/41-900/.. -155/41 -167/02 -6/01 -167/02 -6/01-900/.. -167/02-900/.. -17/41 -195/02 -19/01 -195/02-900/..</p>	<p>91-042 181-93   </p>  <p>-168/02 -168/02-900/..</p>
<p>91-042 819-93   </p>  <p>-17/01 -40/11 -155/01 -39/01 -40/11-900/11;/51 -155/21 -39/21 -40/61 -195/04 -39/22 -40/61-900/11;/51 -39/81 -95/04</p>	<p>91-046 657-93   </p>  <p>-248/02 -248/02-900/..</p>	<p>91-046 720-93   </p>  <p>-226/02 -226/02-900/..</p>	<p>91-049 021-93   </p>  <p>-17/43 -17/43-900/.. -136/02 -136/02-900/..</p>
<p>91-040 533-23   </p> 	<p>91-040 600-23   </p> 	<p>91-040 638-23   </p>  <p>-42/02 -42/02-900/..</p>	

91-040 798-23 

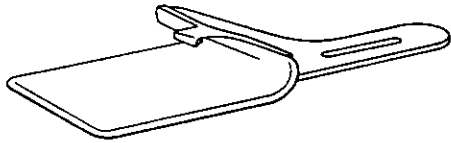

-195/02  
-195/02-900/..

91-041 006-23 

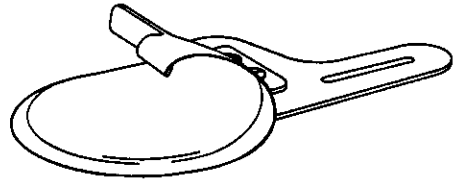

-19/01  
19/01-900/..

91-041 111-23 

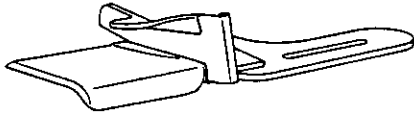

-17/41

91-041 112-23 

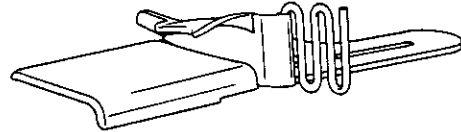

-155/41

91-041 113-23 

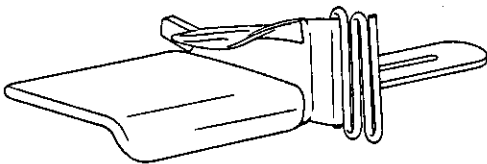

-39/41

91-041 382-23 

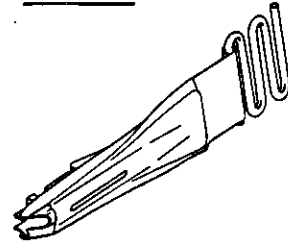

-39/21

91-041 959-23 

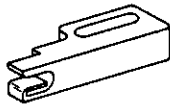

-95/04

91-041 969-25 

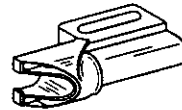

-39/01

91-041 991-25 



-195/04

91-042 099-23 

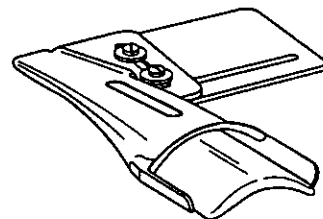

-167/02  
-167/02-900/..

Unterklassen-Übersicht/ Table of subclasses/ Table des sous-classes/ Tabla de subclasses

91-042 179-23 [5]

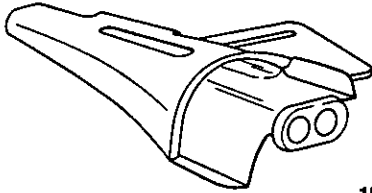

-168/02  
-168/02-900/..

91-043 921-24 [5]

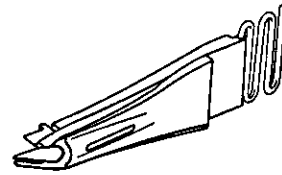

-155/21

91-044 408-23 [5]

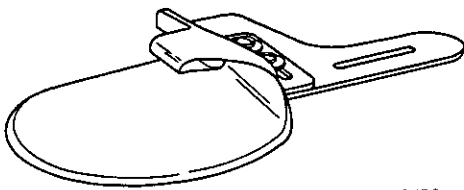

-19/02  
-19/02-900/..

91-046 265-25 [5]

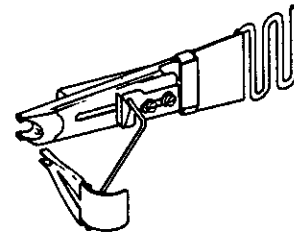

-39/22

91-046 331-24 [5]

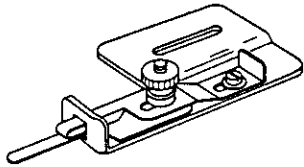

-40/61  
-40/61-900/11: /51

91-046 653-21 [5]



-248/02  
-248/02-900/..

91-046 721-25 [5]

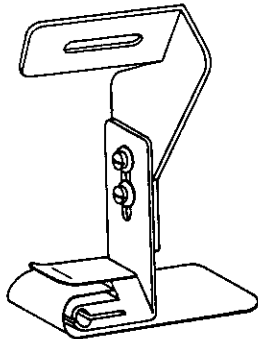

-226/02  
226/02-900/..

91-053 078-23 [5]

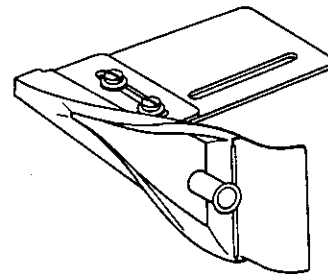

-136/02  
-136/02-900/..

91-053 132-25 

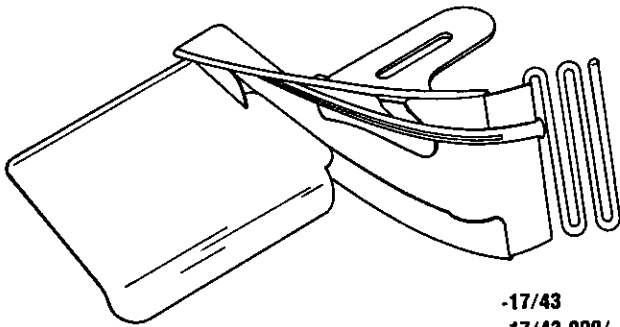

-17/43  
-17/43-900/..

91-053 257-93 

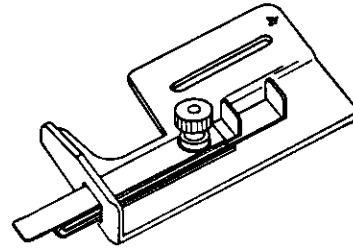

-40/41  
-40/41-900/..

91-053 674-23 

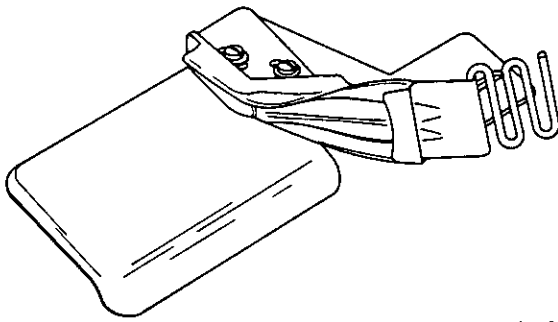

-39/81

91-053 676-25 

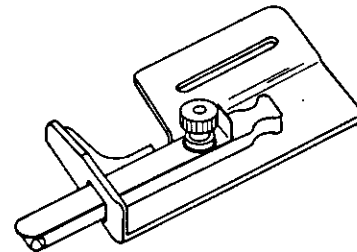

-40/11  
-40/11-900/11; /51

91-040 528-90

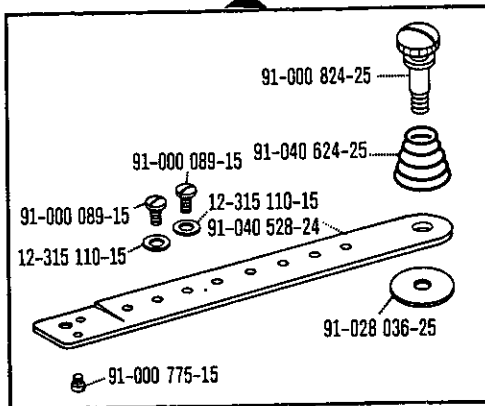

-17/41  
-17/43  
-17/43-900/..  
-19/01  
-19/01-900/..  
-19/02  
-19/02-900/..  
-39/41  
-39/81  
-42/02  
-42/02-900/..  
-136/02  
-136/02-900/..  
-155/21  
-167/02  
-167/02-900/..  
-168/02  
-168/02-900/..  
-195/02  
-195/02-900/..

91-040 862-90

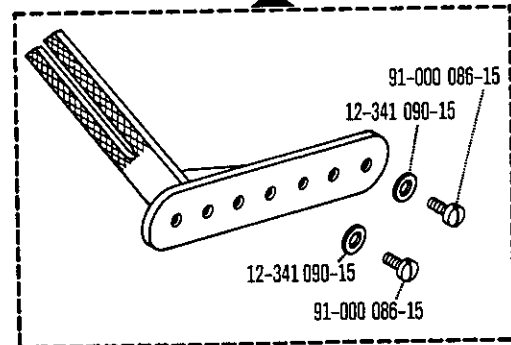

-226/02  
-226/02-900/..



Unterklassen-Übersicht/ Table of subclasses/ Table des sous-classes/ Tabla de subclases

91-042 940-90

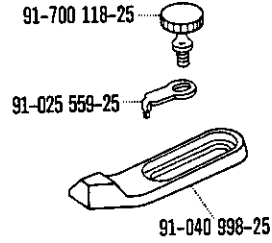
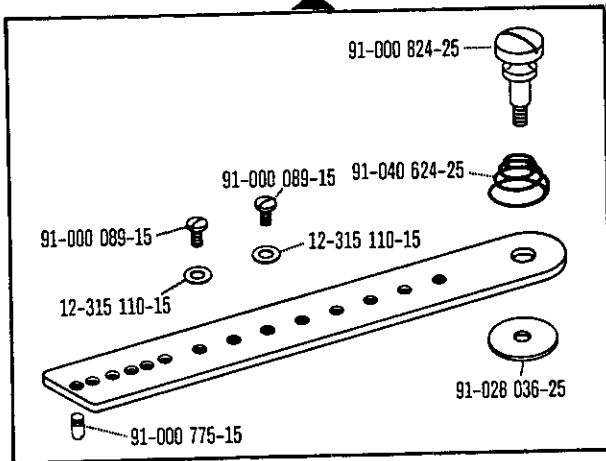

-40/11                      -40/61  
 -40/11-900/11; /51    -40/61-900/11; /51  
 -40/41                      -248/02  
 -40/41-900/..            -248/02-900/..

-2/01  
 -2/01-900/11; /51

91-045 607-90

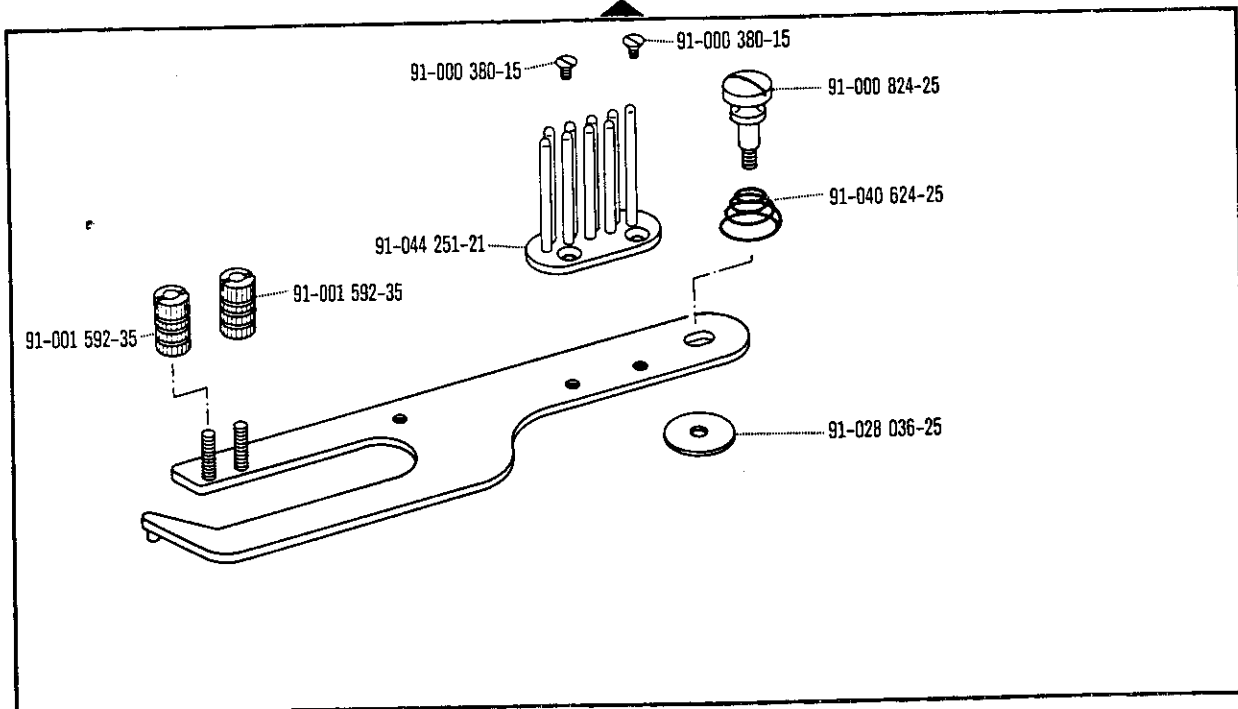

-17/01                      -95/04  
 -39/01                      -155/01  
 -39/21                      -155/21  
 -39/22                      -195/04

91-010 702-91

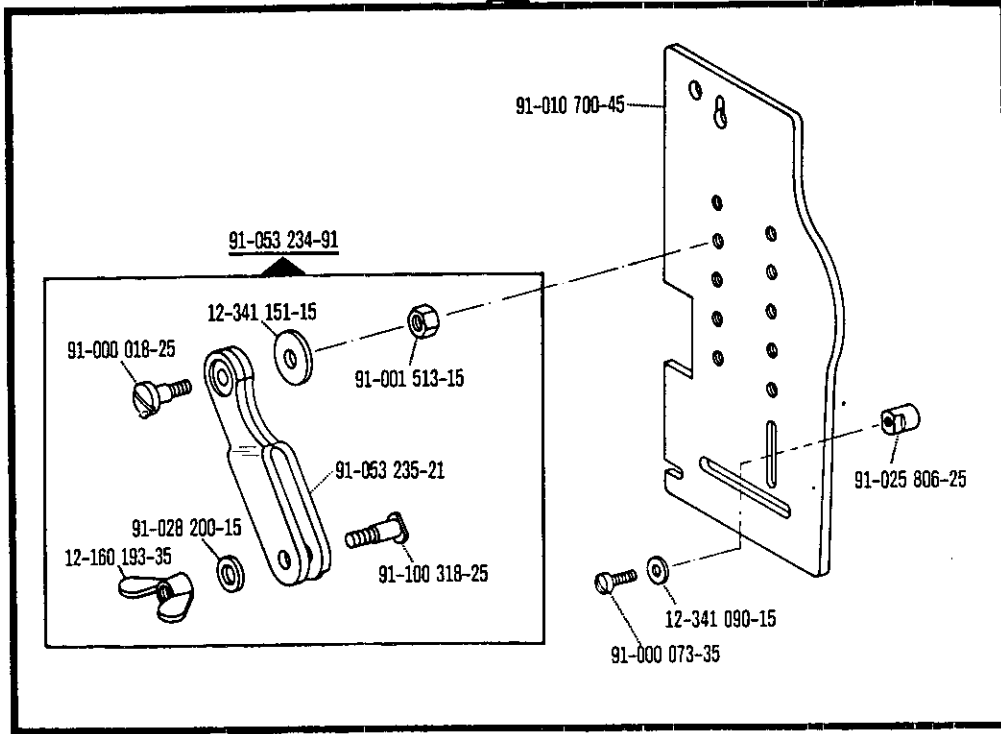

-226/02  
-226/02-900/..

91-043 938-91

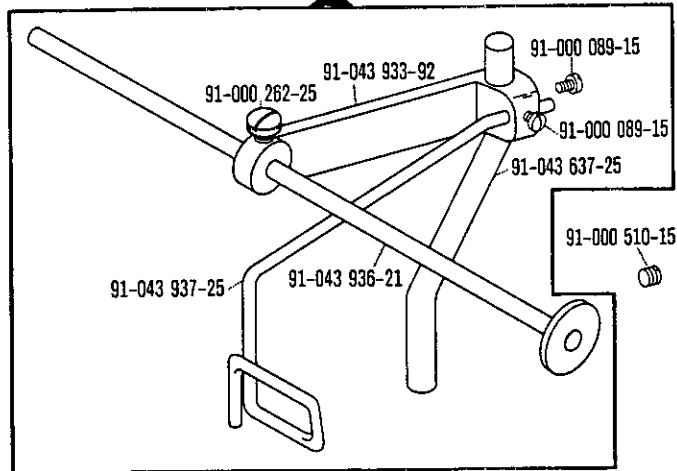

-226/02  
-226/02-900/.. 10

Unterklassen-Übersicht/Table of subclasses/Table des sous-classes/Tabla de subclases

91-043 943-91

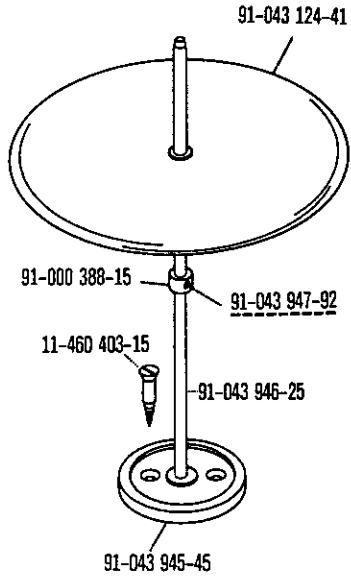

-17/01  
-17/41  
-39/01  
-39/21  
-39/22  
-39/41  
-39/81  
-155/01  
-155/21  
-155/41

91-010 625-24

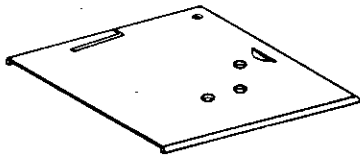

-40/11  
-40/41  
-40/61  
-248/02

91-492 006-25

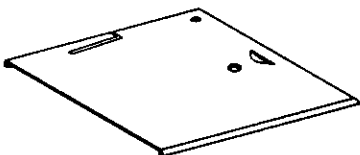

-40/11-900/11; /51  
-40/41-900/..  
-40/61-900/11; /51  
-248/02-900/..

91-055 203-91

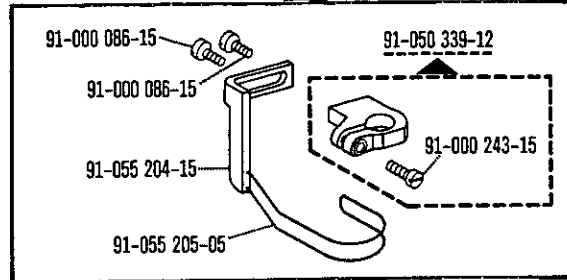

-2/01	-40/61
-2/01-900/11; /51	-40/61-900/11; /51
-6/01	-42/02
-6/01-900/..	-42/02-900/..
-17/01	-95/04
-17/41	-136/02
-17/43	-136/02-900/..
-17/43-900/..	-155/01
-19/01	-155/21
-19/01-900/..	-155/41
-19/02	-167/02
-19/02-900/..	-167/02-900/..
-39/01	-168/02
-39/21	-168/02-900/..
-39/22	-195/02
-39/41	-195/02-900/..
-39/81	-195/04
-40/11	-226/02
-40/11-900/11; /51	-226/02-900/..
-40/41	-248/02
-40/41-900/..	-248/02-900/..

# PFAFF

**G.M. PFAFF  
Aktiengesellschaft**

Postfach 3020  
D-67653 Kaiserslautern

Königstr. 154  
D-67655 Kaiserslautern

Telefon: (0631) 200-0  
Telefax: (0631) 172 02  
Telex: 45753 PFAFF D

Gedruckt in der BRD  
Printed in Germany  
Imprimé en R.F.A.  
Impreso en la R.F.A.