

PFAFF

1244

Unterklassen-Ausstattung

Subclass parts

Composition des sous-classes

Composición de las subclases

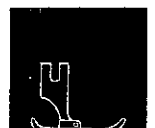
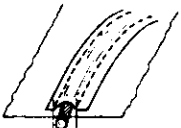
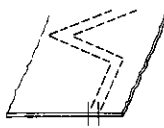
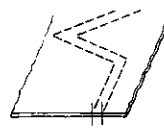
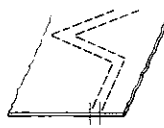

Table des sous-classes
Tabla de subclases PFAFF 1244

| Unterklasse Subclass Sous-classe Subclase | -162/01 | -720/02-944/01 | -720/02-944/01-900/.. | -720/02-944/01 |
|--|---|---|---|--|
| Arbeitsgang Operation Opération Operación |  |  |  |  |
| Ausführung Model Version Tipo de máquina | CN | BN | BN | B/CN |
| Nadelabstand in mm Needle gauge in mm Ecartement des aiguilles en mm Distancia entre agujas en mm | 5,7; 7,2 | 2,0 | 2,0 | 2,4 - 7,2 |
| Nadelstange $\boxed{10/2}$ Needle bar Barre à aiguille Barra de aguja | | 91-140 631-91 | 91-140 631-91 | 91-140 631-91 $\boxed{10}$ = 2,4 - 2,8 mm 91-140 637-91 $\boxed{10}$ = 3,2 - 7,2 mm |
| Nadelhalter $\boxed{10/2}$ Needle holder Pince-aiguille Portaagujas | 91-710 004-93 | 91-019 916-13 | 91-019 916-13 | 91-019 916-13 $\boxed{10}$ = 2,4 - 2,8 mm 91-019 930-13 $\boxed{10}$ = 3,2 - 7,2 mm |
| Nähfuß $\boxed{4}$ $\boxed{10/2}$ Presser foot Pied presseur Pie prensatelas | 91-057 135-03 | | | |
| Rollfuß $\boxed{4}$ Roller presser Pied à roulette Pie rodante | | 91-051 138-93 | 91-051 138-93 | 91-051 138-93 |
| Drückfuß $\boxed{4}$ $\boxed{10/2}$ Presser foot Pied presseur Pie prensatelas | | 91-010 816-03 | 91-010 816-03 | 91-010 816-03 |
| Stichplatte $\boxed{4}$ $\boxed{10/2}$ Needle plate Plaque à aiguille Placa de aguja | 91-048 875-04 | 91-048 496-04 | 91-058 877-04 | 91-058 736-04 |
| Stoffschieber $\boxed{4}$ $\boxed{10/2}$ Feed dog Griffe Transportador interior | 91-047 959-04 | 91-046 300-04 | 91-047 301-04 | 91-047 826-04 |
| Bandführung Tape guide Guide-ruban Guiacintas | 91-053 115-91 | | | |

| Unterklasse Subclass Sous-classe Subclase | -720/02-944/01-900/.. | -750/01-4/01 | -750/01-4/01 | -750/01-4/01-900/.. |
|---|--|--|--|--|
| Arbeitsgang Operation Opération Operación |  | Für Stepparbeiten an Schuhschäften und sonstigen Lederwaren mittels angetriebenem Rollfuß. For stitching shoe uppers and other leather articles with driven roller presser. Travaux de piquage sur tiges ou autres articles en cuir, par pied à roulette entraînée. Para trabajos de respunteado en cortes de calzado y en artículos de cuero mediante pie rodante accionado. | Für Stepparbeiten an Schuhschäften und sonstigen Lederwaren mittels angetriebenem Rollfuß. For stitching shoe uppers and other leather articles with driven roller presser. Travaux de piquage sur tiges ou autres articles en cuir, par pied à roulette entraînée. Para trabajos de respunteado en cortes de calzado y en artículos de cuero mediante pie rodante accionado. | Für Stepparbeiten an Schuhschäften und sonstigen Lederwaren mittels angetriebenem Rollfuß. For stitching shoe uppers and other leather articles with driven roller presser. Travaux de piquage sur tiges ou autres articles en cuir, par pied à roulette entraînée. Para trabajos de respunteado en cortes de calzado y en artículos de cuero mediante pie rodante accionado. |
| Ausführung Model Version Tipo de máquina | B/CN | CN 8; DN 8 | CN 8; DN 8 | CN 8 |
| Nadelabstand in mm Needle gauge in mm Ecartement des aiguilles en mm Distancia entre agujas en mm | 2,4 - 7,2 | 1,6 - 3,2 | 3,6 - 7,2 | 1,6 - 7,2 |
| Nadelstange 10/2 Needle bar Barre à aiguille Barra de aguja | 91-140 631-91 10 = 2,4 - 2,8 mm 91-140 637-91 10 = 3,2 - 7,2 mm | | | |
| Nadelhalter 10/2 Needle holder Pince-aiguille Portaagujas | 91-019 916-93 10 = 2,4 - 2,8 mm 91-019 930-13 10 = 3,2 - 7,2 mm | 91-118 195-93 x 3,6 41/2 | 91-119 309-93 | 91-118 195-93 x 3,6 41/2 10 = 1,6 - 3,2 mm 91-119 309-93 10 = 3,6 - 7,2 mm |
| Rollfuß 4 Roller presser Pied à roulette Pie rodante | 91-051 138-93 | 91-141 232-13 x 0,8 95/6 | 91-141 232-13 x 0,8 95/6 | 91-141 232-13 x 0,8 95/6 |
| Drückertuß 4 10/2 Presser foot Pied presseur Pie prensatelas | 91-010 816-03 | 91-015 558-04 | 91-010 882-04 | 91-015 558-04 10 = 1,6 - 3,2 mm 91-010 882-04 10 = 3,6 - 7,2 mm |
| Fingerschutz Finger guard Protège-doigts Salvadedos | | 91-012 658-91 | 91-012 658-91 | 91-012 658-91 |
| Stichplatte 4 10/2 Needle plate Plaque à aiguille Placa de aguja | 91-058 845-04 | 91-058 441-04 | 91-058 736-04 | 91-058 835-04 10 = 1,6 - 3,2 mm 91-058 845-04 10 = 3,6 - 7,2 mm |
| Stoffschieber 4 10/2 Feed dog Griffe Transportador inferior | 91-047 949-04 10 = 2,4 - 3,6 mm 91-059 005-04 10 = 4,0 - 7,2 mm | 91-047 826-04 | 91-047 826-04 | 91-059 067-04 10 = 1,6 - 3,6 mm 91-059 005-04 10 = 4,0 - 7,2 mm |

Table des sous-classes
Tabla de subclases

PFAFF 1244

| Unterklasse Subclass Sous-classe Subclase | -750/01-4/01-900/.. | -944/01 | -944/01 | -944/01-900/.. | -944/01-900/.. |
|--|--|--|--|--|--|
| Arbeitsgang Operation Opération Operación | Für Stepparbeiten an Schuhschäften und sonstigen Lederwaren mittels angetriebenem Rollfuß. For stitching shoe uppers and other leather articles with driven roller presser. Travaux de piquage sur tiges ou autres articles en cuir, par pied à roulette entraînée. Para trabajos de pespunteado en cortes de calzado y en artículos de cuero mediante pie rodante accionado. | Für Stepparbeiten an Schuhschäften und sonstigen Lederwaren mittels angetriebenem Rollfuß. For stitching shoe uppers and other leather articles with driven roller presser. Travaux de piquage sur tiges ou autres articles en cuir, par pied à roulette entraînée. Para trabajos de pespunteado en cortes de calzado y en artículos de cuero mediante pie rodante accionado. | Für Stepparbeiten an Schuhschäften und sonstigen Lederwaren mittels angetriebenem Rollfuß. For stitching shoe uppers and other leather articles with driven roller presser. Travaux de piquage sur tiges ou autres articles en cuir, par pied à roulette entraînée. Para trabajos de pespunteado en cortes de calzado y en artículos de cuero mediante pie rodante accionado. | Für Stepparbeiten an Schuhschäften und sonstigen Lederwaren mittels angetriebenem Rollfuß. For stitching shoe uppers and other leather articles with driven roller presser. Travaux de piquage sur tiges ou autres articles en cuir, par pied à roulette entraînée. Para trabajos de pespunteado en cortes de calzado y en artículos de cuero mediante pie rodante accionado. | Für Stepparbeiten an Schuhschäften und sonstigen Lederwaren mittels angetriebenem Rollfuß. For stitching shoe uppers and other leather articles with driven roller presser. Travaux de piquage sur tiges ou autres articles en cuir, par pied à roulette entraînée. Para trabajos de pespunteado en cortes de calzado y en artículos de cuero mediante pie rodante accionado. |
| Ausführung Model Version Tipo de máquina | C/DN 8 | CN 8; DN 8 | CN 8; DN 8 | CN 8 | C/DN 8 |
| Nadelabstand in mm Needle gauge in mm Ecartement des aiguilles en mm Distancia entre agujas en mm | 2,0 - 7,2 | 1,6 - 3,2 | 3,6 - 7,2 | 1,6 - 7,2 | 2,0 - 7,2 |
| Nadelhalter $\left[\begin{smallmatrix} 10 \\ 2 \end{smallmatrix} \right]$ Needle holder Pince-aiguille Portaagujas | 91-118 195-93 x 3,6 $\left[\begin{smallmatrix} 41 \\ 2 \end{smallmatrix} \right]$ $\left[\begin{smallmatrix} 10 \\ 0 \end{smallmatrix} \right]$ = 2,0 - 3,2 mm 91-119 309-93 $\left[\begin{smallmatrix} 10 \\ 0 \end{smallmatrix} \right]$ = 3,6 - 7,2 mm | 91-118 195-93 x 3,6 $\left[\begin{smallmatrix} 41 \\ 2 \end{smallmatrix} \right]$ | 91-119 309-93 | 91-118 195-93 x 3,6 $\left[\begin{smallmatrix} 41 \\ 2 \end{smallmatrix} \right]$ $\left[\begin{smallmatrix} 10 \\ 0 \end{smallmatrix} \right]$ = 1,6 - 3,2 mm 91-119 309-93 $\left[\begin{smallmatrix} 10 \\ 0 \end{smallmatrix} \right]$ = 3,6 - 7,2 mm | 91-118 195-93 x 3,6 $\left[\begin{smallmatrix} 41 \\ 2 \end{smallmatrix} \right]$ $\left[\begin{smallmatrix} 10 \\ 0 \end{smallmatrix} \right]$ = 2,0 - 3,2 mm 91-119 309-93 $\left[\begin{smallmatrix} 10 \\ 0 \end{smallmatrix} \right]$ = 3,6 - 7,2 mm |
| Rollfuß $\left[\begin{smallmatrix} 4 \\ 1 \end{smallmatrix} \right]$ Roller presser Pied à roulette Pie rodante | 91-141 232-13 x 0,8 $\left[\begin{smallmatrix} 95 \\ 6 \end{smallmatrix} \right]$ | 91-051 159-93 | 91-051 159-93 | 91-051 159-93 | 91-051 159-93 |
| Drückertfuß $\left[\begin{smallmatrix} 4 \\ 10 \\ 2 \end{smallmatrix} \right]$ Presser foot Pied presseur Pie prensatelas | 91-115 558-04 $\left[\begin{smallmatrix} 10 \\ 0 \end{smallmatrix} \right]$ = 2,0 - 3,2 mm 91-010 882-04 $\left[\begin{smallmatrix} 10 \\ 0 \end{smallmatrix} \right]$ = 3,6 - 7,2 mm | 91-015 558-04 | 91-010 882-04 | 91-015 558-04 $\left[\begin{smallmatrix} 10 \\ 0 \end{smallmatrix} \right]$ = 1,6 - 3,2 mm 91-010 882-04 $\left[\begin{smallmatrix} 10 \\ 0 \end{smallmatrix} \right]$ = 3,6 - 7,2 mm | 91-015 558-04 $\left[\begin{smallmatrix} 10 \\ 0 \end{smallmatrix} \right]$ = 2,0 - 3,2 mm 91-010 882-04 $\left[\begin{smallmatrix} 10 \\ 0 \end{smallmatrix} \right]$ = 3,6 - 7,2 mm |
| Fingerschutz Finger guard Protège-doigts Salvadedos | 91-012 658-91 | 91-157 813-91 | 91-157 813-91 | 91-157 813-91 | 91-157 813-91 |
| Stichplatte $\left[\begin{smallmatrix} 4 \\ 10 \\ 2 \end{smallmatrix} \right]$ Needle plate Plaque à aiguille Placa de aguja | 91-058 835-04 $\left[\begin{smallmatrix} 10 \\ 0 \end{smallmatrix} \right]$ = 2,0 - 3,2 mm 91-058 845-04 $\left[\begin{smallmatrix} 10 \\ 0 \end{smallmatrix} \right]$ = 3,6 - 7,2 mm | 91-058 441-04 | 91-058 736-04 | 91-058 835-04 $\left[\begin{smallmatrix} 10 \\ 0 \end{smallmatrix} \right]$ = 1,6 - 3,2 mm 91-058 845-04 $\left[\begin{smallmatrix} 10 \\ 0 \end{smallmatrix} \right]$ = 3,6 - 7,2 mm | 91-058 835-04 $\left[\begin{smallmatrix} 10 \\ 0 \end{smallmatrix} \right]$ = 2,0 - 3,2 mm 91-058 845-04 $\left[\begin{smallmatrix} 10 \\ 0 \end{smallmatrix} \right]$ = 3,6 - 7,2 mm |
| Stoffschieber $\left[\begin{smallmatrix} 4 \\ 10 \\ 2 \end{smallmatrix} \right]$ Feed dog Griffe Transportador inferior | 91-059 067-04 $\left[\begin{smallmatrix} 10 \\ 0 \end{smallmatrix} \right]$ = 2,0 - 3,6 mm 91-059 005-04 $\left[\begin{smallmatrix} 10 \\ 0 \end{smallmatrix} \right]$ = 4,0 - 7,2 mm | 91-047 826-04 | 91-047 826-04 | 91-059 067-04 $\left[\begin{smallmatrix} 10 \\ 0 \end{smallmatrix} \right]$ = 1,6 - 3,6 mm 91-059 005-04 $\left[\begin{smallmatrix} 10 \\ 0 \end{smallmatrix} \right]$ = 4,0 - 7,2 mm | 91-059 067-04 $\left[\begin{smallmatrix} 10 \\ 0 \end{smallmatrix} \right]$ = 2,0 - 3,2 mm 91-059 005-04 $\left[\begin{smallmatrix} 10 \\ 0 \end{smallmatrix} \right]$ = 4,0 - 7,2 mm |

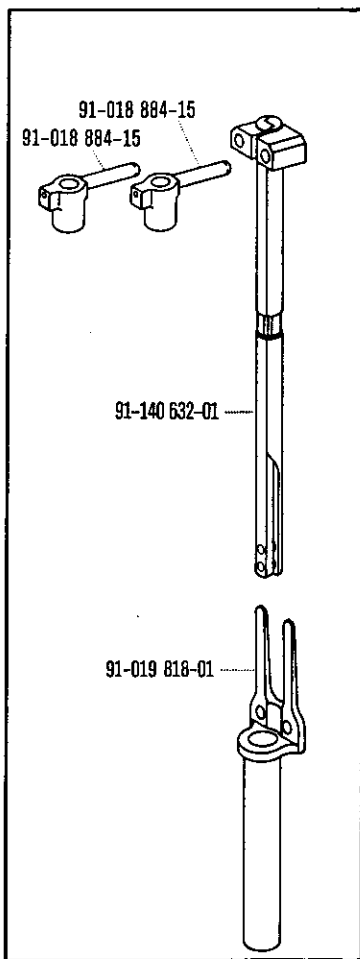

91-140 631-91

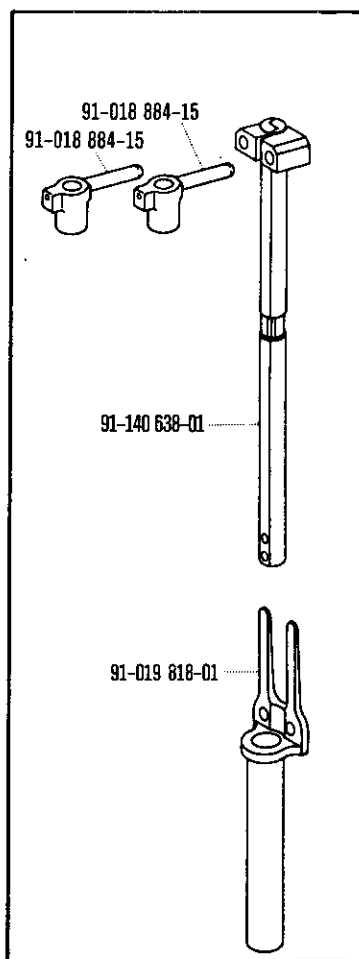

91-140 637-91

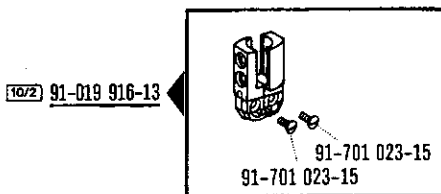

-720/02-944/01
 -720/02-944/01-900/56

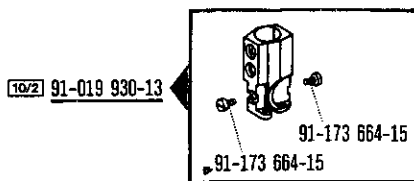

-720/02-944/01
 -720/02-944/01-900/56

91-118 195-93 x 3,6 (10/2) (41/2)

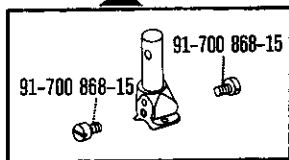

-750/01-4/01
 -750/01-4/01-900/56
 -944/01
 -944/01-900/56

91-119 309-93 (10/2)

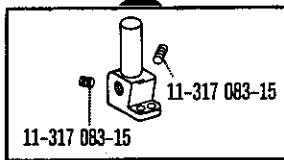

-750/01-4/01
 -750/01-4/01-900/56
 -944/01
 -944/01-900/56

91-710 004-93 (10/2)

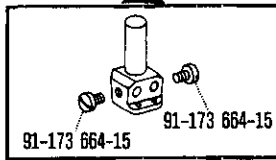





-162/01

91-051 138-93 (4) (10/2)



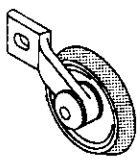
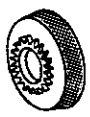
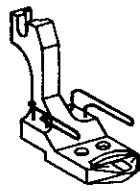
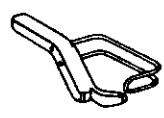

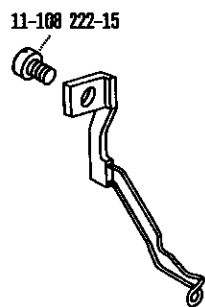
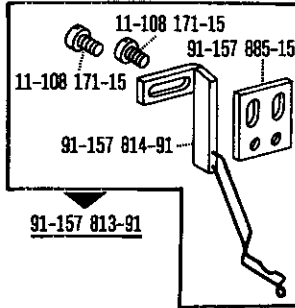
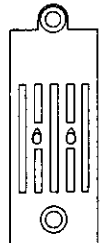
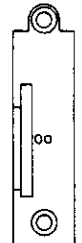

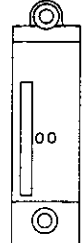
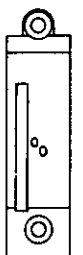
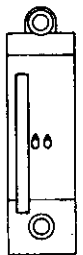
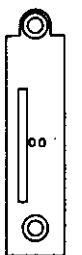
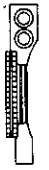
-720/02-944/01
 -720/02-944/01-900/56

Organe parts
 Organes de couture
 Organos de costura PFAFF 1244

| | | | |
|--|--|---|---|
| <p>91-051 159-93 4 10/2</p>  <p>-944/01 -944/01-900/56</p> | <p>91-141 232-13 x 0,8 95/6</p>  <p>-750/01-4/01 -750/01-4/01-900/56</p> | <p>91-057 135-03 4 3 10/2</p>  <p>-162/01</p> | <p>91-010 816-03 4 10/2</p>  <p>-720/02-944/01 -720/02-944/01-900/56</p> |
| <p>91-010 882-04 4 10/2</p>  <p>-750/01-4/01 -750/01-4/01-900/56 -944/01 -944/01-900/56</p> | <p>91-015 558-04 4 10/2</p>  <p>-750/01-4/01 -750/01-4/01-900/56 -944/01 -944/01-900/56</p> | <p>91-012 658-91</p>  <p>-750/01-4/01 -750/01-4/01-900/56</p> | <p>11-108 222-15</p>  <p>-944/01 -944/01-900/56</p> |
| <p>91-048 875-04 4 10/2</p>  <p>-162/01</p> | <p>91-048 496-04 4 10/2</p>  <p>-720/02-944/01</p> | <p>91-058 441-04 4 10/2</p>  <p>-750/01-4/01 -944/01</p> | <p>91-058 736-04 4 10/2</p>  <p>-720/02-944/01 -750/01-4/01 -944/01</p> |
| <p>91-058 835-04 4 10/2</p>  <p>-750/01-4/01-900/56 -944/01-900/56</p> | <p>91-058 845-04 4 10/2</p>  <p>-720/02-944/01-900/56 -750/01-4/01-900/56 -944/01-900/56</p> | <p>91-058 877-04 4 10/2</p>  <p>-720/02-944/01-900/56</p> | <p>91-046 300-04 4 10/2</p>  <p>-720/02-944/01</p> |

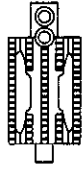
Gauge parts
 Organes de couture
 Organos de costura PFAFF 1244

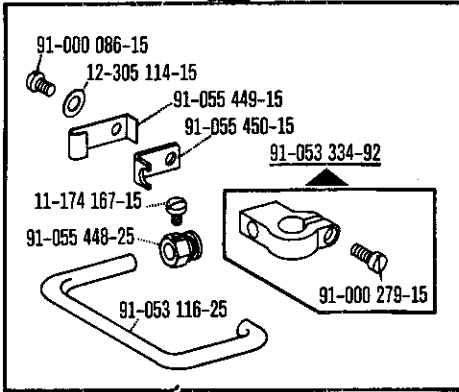
| | | | |
|---|--|--|--|
| <p>91-047 301-04 4 10/2</p>  <p>-720/02-944/01-900/56</p> | <p>91-047 826-04 4 10/2</p>  <p>-720/02-944/01 -750/01-4/01 -944/01</p> | <p>91-047 949-04 4 10/2</p>  <p>-720/02-944/01-900/56</p> | <p>91-047 959-04 4 10/2</p>  <p>-162/01</p> |
| <p>91-059 005-04 4 10/2</p>  <p>-720/02-944/01-900/56 -750/01-4/01-900/56 -944/01-900/56</p> | <p>91-059 067-04 4 10/2</p>  <p>-750/01-4/01-900/56 -944/01-900/56</p> | <p style="text-align: center;">91-053 115-91</p>  <p style="text-align: right;">-162/01</p> | |

☐ siehe Erläuterungen Register A B
 see explanations in section A B
 voir légende registre A B

PFAFF

**G.M. PFAFF
Aktiengesellschaft**

Postfach 3020
D-67653 Kaiserslautern

Königstr. 154
D-67655 Kaiserslautern

Telefon: (0631) 200-0
Telefax: (0631) 172 02
Telex: 45753 PFAFF D

Gedruckt in der BRD
Printed in Germany
Imprimé en R.F.A.
Impreso en la R.F.A.