



MITSUBISHI

Industrial Sewing Machines

XC-EMFY



TECHNICAL QUICK REFERENCE CONTENTS

DIGITAL DISPLAY/ PAGE 1

HOW TO ENTER THE VARIOUS PROGRAM MODES/ PAGES 2-3

PANEL KEY FUNCTIONS/ PAGE 4

HOW TO ENTER THE MODE FOR MITSUBISHI MACHINES/ PAGE 5

LIST OF MITSUBISHI MACHINES TO SELECT FROM/ PAGE 6

BACKTACK SETTINGS/ PAGES 7-8

STITCH COUNT SETTINGS/ PAGES 9-10

HOW TO ENTER INTO THE MODE FOR OTHER LOCKSTITCH MACHINES/ PAGE 11

LIST OF OTHER LOCKSTITCH MACHINES TO SELECT FROM/ PAGES 12-13

HOW TO ENTER INTO THE MODE FOR CHAINSTITCH MACHINES/ PAGE 14

LIST OF CHAINSTITCH MACHINES TO SELECT FROM/ PAGES 15-16

MOST COMMONLY USED FUNCTIONS IN THE P AND A MODES/ PAGE 17

MOST COMMONLY USED FUNCTIONS IN THE J AND R MODES/ PAGE 18

FUSES/ PAGE 19

HOW TO USE SINGLE PHASE 220V/ PAGE 20

HOW TO CHANGE THE 24/ 30 VOLT POWER SUPPLY/ PAGE 21

HOW TO CHANGE THE 5/ 12 VOLT POWER SUPPLY FOR THE VARIOUS CONNECTORS/ PAGES 22-23

HOW TO CHANGE THE SOLENOID RETURN SPEED/ PAGE 24

TROUBLESHOOTING/ PAGE 25

ERROR CODES/ PAGE 26

OPTION CONNECTOR LAY-OUT/ PAGE 27

WIRING FOR NEEDLE COOLER OUTPUT AND SENSOR/ PAGE 28

PROGRAM BACK-UP/ PAGE 29

USING THE XC-E500 TO TRANSFER PARAMETER SETTINGS/ PAGE 30

HOW TO SET UP THE BACKTACK SWITCHES AA-G003-925/ PAGES 31-32

CHART OF THE INPUT/ OUTPUT CONTROL/ PAGE 33

CHART OF THE INPUT/ OUTPUT COUPLING/ PAGE 34

CHART OF THE INPUT/ OUTPUT COMMON PORT/ PAGE 35

INPUT/ OUTPUT FUNCTION LIST/ PAGES 36-41

Numeral	0	1	2	3	4	5	6	7	8	9
Digital display	<i>0</i>	<i>1</i>	<i>2</i>	<i>3</i>	<i>4</i>	<i>5</i>	<i>6</i>	<i>7</i>	<i>8</i>	<i>9</i>
Characters	A	B	C	D	E	F	G	H	I	J
Digital display	<i>A</i>	<i>b</i>	<i>C</i>	<i>d</i>	<i>E</i>	<i>F</i>	<i>G</i>	<i>H</i>	<i>I</i>	<i>J</i>
Characters	K	L	M	N	O	P	Q	R	S	T
Digital display	<i>k</i>	<i>L</i>	<i>M</i>	<i>n</i>	<i>o</i>	<i>P</i>	<i>q</i>	<i>r</i>	<i>S</i>	<i>T</i>
Characters	U	V	W	X	Y	Z				
Digital display	<i>U</i>	<i>v</i>	<i>W</i>	<i>X</i>	<i>Y</i>	<i>Z</i>				

HOW TO ENTER THE PROGRAM MODES

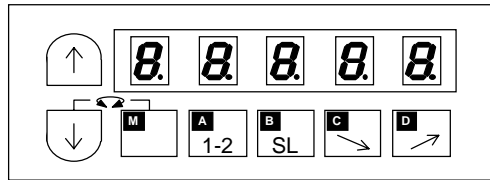

TO RETURN TO THE NORMAL MODE, PRESS THE DOWN ARROW AND UP ARROW MOMENTARIALLY

Mode name	Key operation	Digital display
Tacking type setting mode	PRESS THE UP ARROW KEY 1 TIME	*The tacking setting mode will be entered. Note) Skipping about this menu at the time of pattern No.=4.
No. of tacking stitch setting mode	PRESS THE UP ARROW KEY 2 TIMES	*The tacking stitches setting mode will be entered.
Preset stitching setting mode	PRESS THE UP ARROW KEY 3 TIMES	*The preset stitching setting mode will be entered. Note) Skipping about this menu at the time of pattern A to H.
Pattern No. selection mode	PRESS THE UP ARROW KEY 4 TIMES	*The pattern No. selection mode will be entered.
Program mode [P]	PRESS AND HOLD IN THE DOWN ARROW AND THE UP ARROW KEY	*The display will flicker. *The program mode [P] will be entered.
Program mode [A]	PRESS AND HOLD IN THE DOWN ARROW AND THE A KEY	*The display will flicker. *The program mode [A] will be entered.
Program mode [B]	PRESS AND HOLD IN THE DOWN ARROW AND THE B KEY	*The display will flicker. *The program mode [B] will be entered.
Program mode [C]	PRESS AND HOLD IN THE DOWN ARROW AND THE C KEY	*The display will flicker. *The program mode [C] will be entered.
Program mode [D]	PRESS AND HOLD IN THE DOWN ARROW AND THE D KEY	*The display will flicker. *The program mode [D] will be entered.
Program mode [E]	PRESS AND HOLD IN THE DOWN ARROW AND THE UP ARROW AND THE A KEY	*The display will flicker. *The program mode [E] will be entered.
Program mode [F]	PRESS AND HOLD IN THE DOWN ARROW AND THE UP ARROW AND THE B KEY	*The display will flicker. *The program mode [F] will be entered.
Program mode [G]	PRESS AND HOLD IN THE DOWN ARROW AND THE UP ARROW AND THE C KEY	*The display will flicker. *The program mode [G] will be entered.

HOW TO ENTER THE PROGRAM MODES

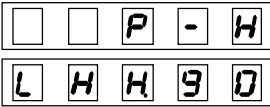
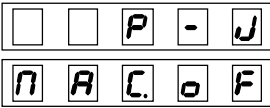
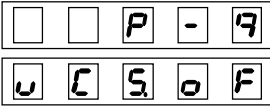
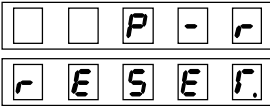
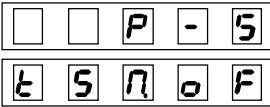
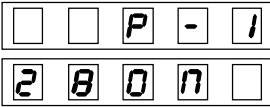
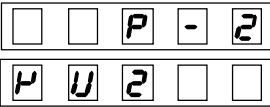
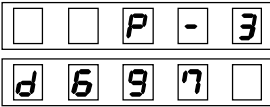
Program mode [H]	PRESS AND HOLD IN THE DOWN ARROW AND THE UP ARROW AND THE D KEY		*The display will flicker. *The program mode [H] will be entered.
Program mode [J]	PRESS AND HOLD IN THE DOWN ARROW AND THE UP ARROW AND THE A AND B KEYS		*The display will flicker. *The program mode [J] will be entered.
Program mode [Q]	PRESS AND HOLD IN THE DOWN ARROW AND THE A AND C KEYS		*The display will flicker. *The program mode [Q] will be entered.
Program mode [R]	PRESS AND HOLD IN THE DOWN ARROW AND THE B AND C KEYS		*The display will flicker. *The program mode [R] will be entered.
Program mode [S]	PRESS AND HOLD IN THE DOWN ARROW AND THE B AND D KEYS		*The display will flicker. *The program mode [S] will be entered.
Program mode [1]	PRESS AND HOLD IN THE DOWN ARROW AND THE A AND B KEYS		*The display will flicker. *The program mode [1] will be entered.
Program mode [2]	PRESS AND HOLD IN THE DOWN ARROW AND THE C AND D KEYS		*The display will flicker. *The program mode [2] will be entered.
Program mode [3]	PRESS AND HOLD IN THE DOWN ARROW AND THE A AND D KEYS		*The display will flicker. *The program mode [3] will be entered.
PROGRAM MODE K	PRESS AND HOLD IN THE DOWN ARROW AND THE UP ARROW AND THE A AND C KEYS		

11. Operation of the Operation Panel Keys

3. How to use the normal mode

(1) Display during normal mode and function of each key

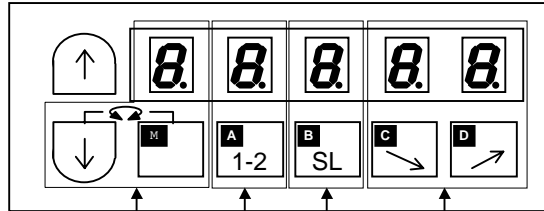

Change motor rotation direction

By operating these two keys (DOWN ARROW + M KEY) simultaneously, the rotation direction of the sewing machine can be changed. THE ROTATING CIRCLE IS THE DIRECTION OF MOTOR ROTATION

Speed adjustment

BY PRESSING THE [C] KEY THE TOP SPEED GETS LOWER
BY PRESSING THE [D] KEY THE TOP SPEED GETS HIGER
THE DISPLAY IS A PERCENTAGE OF THE TOP SPEED SET IN THE P-MODE

Slow start ON/OFF

By operating this [B] key, slow start ON/ OFF can be selected.
Turned ON THE MOTOR ROTATES FOR 2 REVOLUTIONS AT SLOW SPEED.
AMOUNT OF REVOLUTIONS AND SPEED CAN BE SET IN THE P-MODE
After the power is turned ON or after thread trimming, the sewing will start with a slow start.
Slow start ON/ OFF is displayed on LED.B.

 is OFF

 is ON

Change 1 position / 2 position

By operating this [A] key, 1 position / 2 position can be selected for the needle position during stopping.
1 position or 2 position is displayed on LED.A.
At the time of 1 position, the needle is stopped at Up position.
At the time of 2 position, the needle is stopped at Down position.
After thread trimming, the needle is stopped at up position.

 is Up position

 is Down position

3. How to use the program mode [1]

To set the functions for Mitsubishi thread trimming sewing machine in simple setting.
 (ex. To set for the LS2-1280-B1T).....Function setting [280B]

1) PRESS AND HOLD IN THE DOWN ARROW AND THE A KEY AND THE B KEY

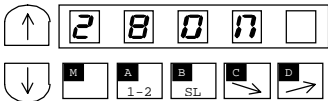
2) 

FIRST MACHINE TYPE IN LIST

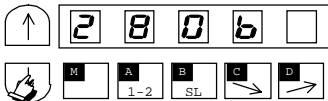
3) 

USE THE DOWN ARROW KEY TO
SELECT THE MACHINE TYPE

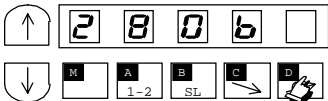
4) 

PRESS AND HOLD IN THE D KEY
UNTIL THE DISPLAY STOPS FLASHING

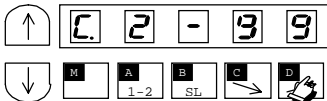
5) 

NORMAL DISPLAY

Simple setting table for Mitsubishi thread trimming sewing machine
and motor pulley outside diameter.

Simple setting table for Mitsubishi thread trimming sewing machine											
Function name	Digital display	Sewing machine type	Speed setting					Function setting			Motor pulley outside diameter (mm)
			High speed (H)	Low speed (L) (H)	Thread trimming speed (T)ubis	Start tacking speed (N)T <u>u</u>	End tacking speed (V)(N)T	D mode Tack alignment (BM)	A mode weak brake (BK)	A mode gain selection (GA)	
280M	280M	LS2-1280-M1T(W)	4000	250	200	1700	1700	OFF	OFF	L	85
280H	280H	LS2-1280-H1TW	3000	250	200	1200	1200	OFF	OFF	L	
280B	280B	LS2-1280-B1T	3000	250	200	1200	1200	OFF	OFF	L	
210M	210M	LS2-2210-M1T(W)	4000	250	200	1700	1700	OFF	OFF	L	85
230M	230M	LT2-2230-M1TW	3700	250	175	1200	1200	OFF	OFF	H	
230L	230L	LT2-2230-L1T	3700	250	175	1200	1200	OFF	OFF	H	
230B	230B	LT2-2230-B1T	3000	250	175	1200	1200	OFF	OFF	H	85
250M	250M	LT2-2250-M1TW	3000	250	175	1200	1200	OFF	OFF	H	
250A	250A	LT2-2250-A1T	3000	250	175	1200	1200	OFF	OFF	H	
250B	250B	LT2-2250-B1T	3000	250	175	1200	1200	OFF	OFF	H	85
3370	3370	LG2-3370-M1T	4000	250	200	1700	1700	OFF	OFF	L	
359	359	DY-359-22BZ	2000	250	200	700	700	ON	OFF	L	
3310	3310	LY2-3310-B1T	2000	250	225	700	700	ON	OFF	H	65
3750	3750	LY2-3750-B1T	2000	250	200	700	700	ON	OFF	L	
410B	410B	LU2-4410-B1T	2000	250	175	700	700	ON	OFF	H	
430B	430B	LU2-4430-B1T	2000	250	175	700	700	ON	OFF	H	85
4710	4710	LU2-4710-B1T	3000	250	175	700	700	ON	OFF	H	
4730	4730	LU2-4730-B1T	2500	250	175	700	700	ON	OFF	H	
630	630	LX2-630-M1	800	280	160	500	500	ON	ON	L	110
280E	280E	LS2-1280-M1T(W)	5000	250	200	1700	1700	OFF	OFF	H	
EFL	EFL	*6	5000	250	200	1700	1700	OFF	OFF	L	
EN	EN	*7	5000	250	200	1700	1700	OFF	OFF	L	*

When the up arrow key is pressed 1 time FROM THE NORMAL MODE, the backtacking mode will be entered
 The validity and type of start and end tacking can be set here.

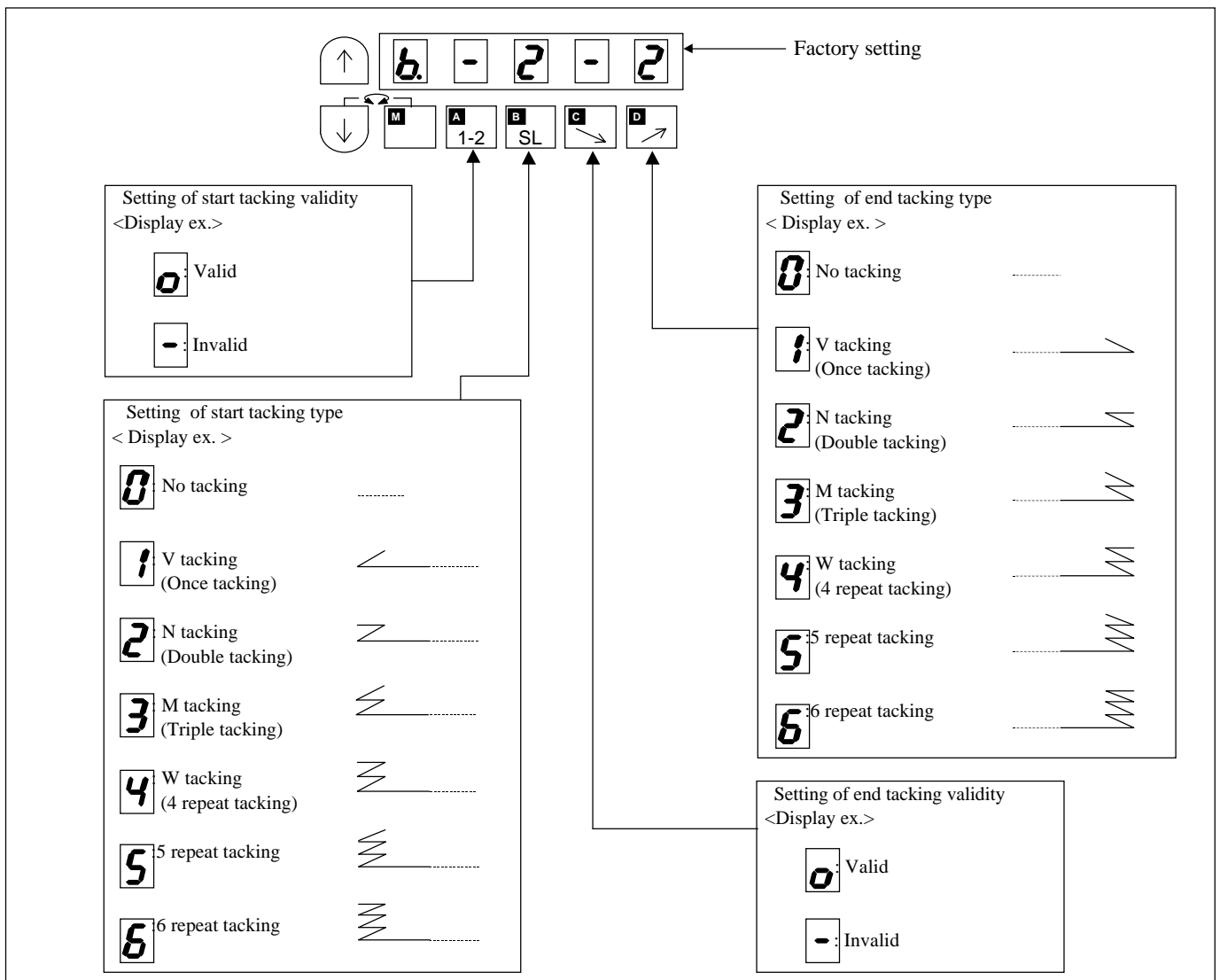

When the up arrow key is pressed 2 times FROM THE NORMAL MODE, the start and end backtacking stitches can be changed

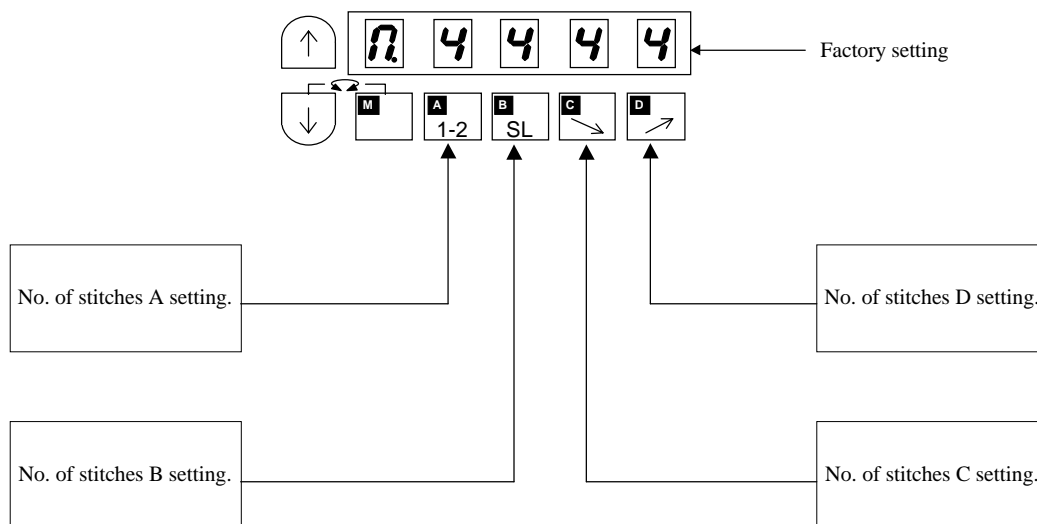

1) The time except pattern No.4

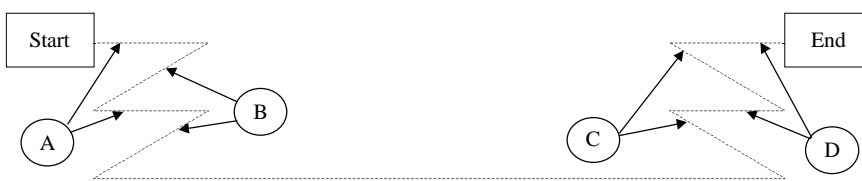

2) When the pattern No.4

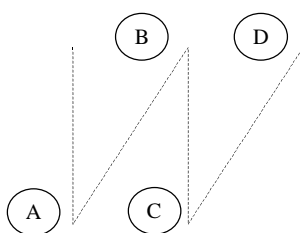

Each setting value can be changed from 0 to 9 stitches, A,B,C,D,E,F stitches

- A is 10 stitches
- B is 11 stitches
- C is 12 stitches
- D is 13 stitches
- E is 14 stitches
- F is 15 stitches

When the up arrow is pressed 3 TIMES FROM THE NORMAL MODE, the stitch counting mode will be entered

THERE ARE UP TO 3 STITCH COUNT PROGRAMS

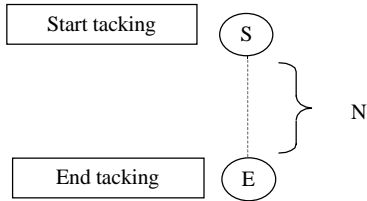
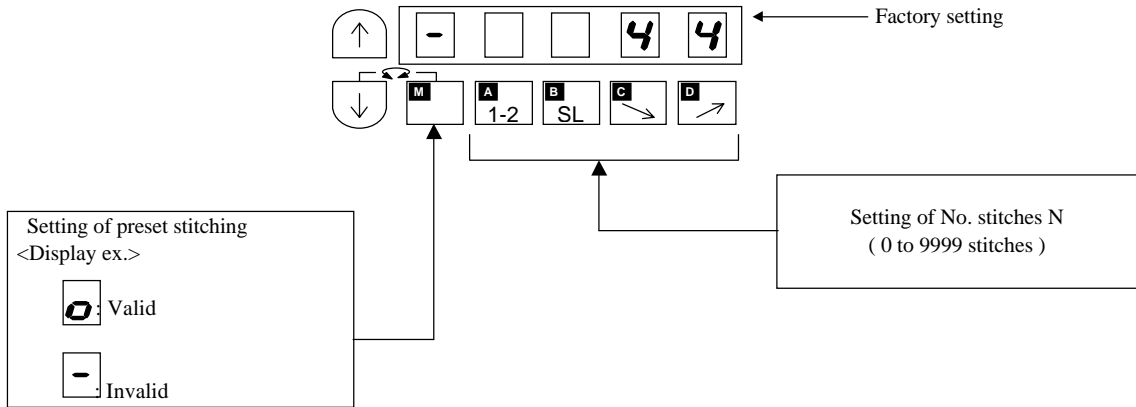

THERE IS 1 CONTINUOUS BACKTACK PROGRAM

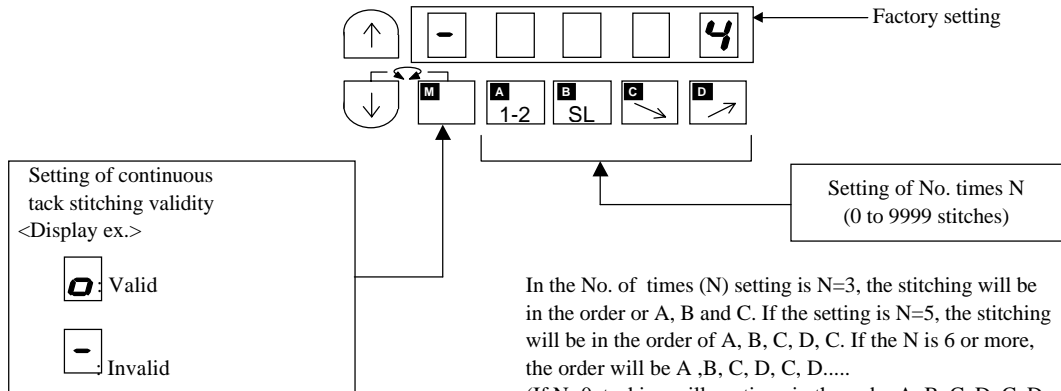

In the No. of times (N) setting is N=3, the stitching will be in the order or A, B and C. If the setting is N=5, the stitching will be in the order of A, B, C, D, C. If the N is 6 or more, the order will be A ,B, C, D, C, D.....
(If N=0, tacking will continue in the order A, B, C ,D ,C ,D...

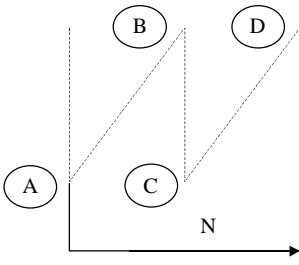

WHEN THE UP ARROW KEY IS PRESSED 4 TIMES FROM THE NORMAL MODE, THE PATTERN SELECT MODE WILL BE ENTERED
 PROGRAMS 0-4 CAN BE SELECTED
 PROGRAMS A-H CAN ALSO BE SELECTED IF THEY HAVE BEEN MADE WITH THE E500

1) Display of preset stitching (Pattern 0 to 3)

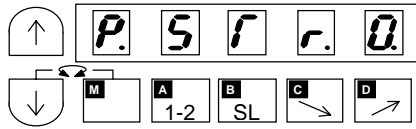

Display of pattern 0.
 When pattern 1,2,3, display show 1,2,3.
 When control panel is connected,
 the pattern 0 disappears.

2) Display of continuous tack stitching (Pattern 4)

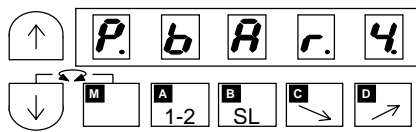

3) Display of program stitching (Pattern A to H)

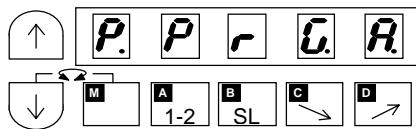

Display of pattern A
 When pattern B, C, D, E, F, G, H display
 show B, C, D, E, F, G, H.

- a. Pattern A through H can be set on control panel "XC-E500Y".
 So when programming will be changed, use control panel "XC-E500Y".
 (Refer to technical manual of control panel in detail.)

Caution

*For safety purposes, always turn off the power switch
 when connecting or disconnecting the control panel.*

13 How to use Simple setting of Program Mode [3] (for lock stitch trimming machine)

1. How to use Simple setting of Program Mode [3] (for lock stitch trimming machine)

1) PRESS AND HOLD IN THE DOWN ARROW AND THE A KEY AND THE D KEY

2)

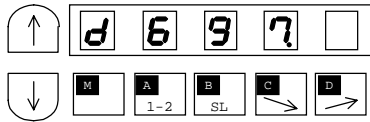

FIRST MACHINE TYPE IN LIST

3)

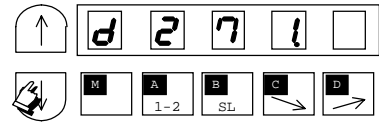

PRESS THE DOWN ARROW KEY TO SELECT THE MACHINE TYPE

4)

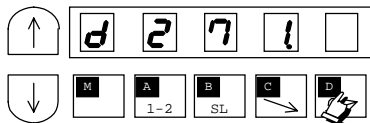

PRESS AND HOLD IN THE D KEY UNTIL THE DISPLAY STOPS FLASHING

5)

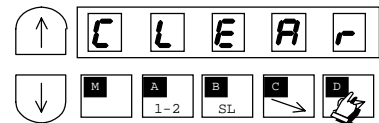

6)

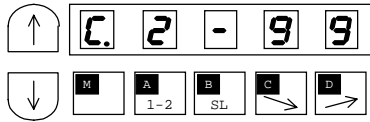

NORMAL MODE

13. Simple Setting of Program Mode [3] (for lock stitch trimming machine)

2. Simple setting table for lock stitch sewing machine

Function	Digital display	Sewing machine maker	Model name of sewing machine and device	I/ O signals of connectors	Junction wiring	Note 1 solenoid voltage	Note 2 DCSV or 12V setting In option A connector	1/ 2 pos	High speed H	Low speed L	Trimming speed T	*Start condensed speed N	End condensed speed V
D697	d697	D RKOPP ADLER	697-15000 class	Fig.20	Fig.58	24V	12V	2	1500	250	150	700	700
D271	d271	D RKOPP ADLER	271-14000,272-14000 class	Fig.21	Fig.59	24V	12V	2	3000	170	250	1500	1500
D273	d273	D RKOPP ADLER	273-14000,274-14000 class	Fig.22	Fig.60	24V	12V	2	3000	170	250	1500	1500
B715	b715	BROTHER	DB2-B705,DB2-B707,DB2-B715 class	Refer to "HOW TO USE WITH OTHER MANUFACTURER' S MACHINE".	Refer to "HOW TO USE WITH OTHER MANUFACTURER' S MACHINE".	30V	5V	2	4300	215	215	1800	1800
B716	b716	BROTHER	DB2-B716-? ,DB2-B716-1,DB2-B716-? ,DB2-B716-5 class			30V	5V	2	3500	215	215	1800	1800
B737	b737	BROTHER	DB2-B737-1,DB2-B737-3,DB2-B737-5 class			30V	5V	2	4000	215	215	1800	1800
B740	b740	BROTHER	DB2-B746-5,DB2-B746-7,DB2-B746-8,DB2-B747-5,DB2-B748-5,DB2-B748-7 class			30V	5V	2	2000	215	215	1800	1800
B757	b757	BROTHER	DB2-B757 class			30V	5V	2	5000	215	215	1800	1800
B770	b770	BROTHER	DB2-B772,DB2-B774,DB2-B7740,DB2-B778 class			30V	5V	2	4500	215	215	1800	1800
B790	b790	BROTHER	DB2-B790,DB2-B791-3,DB2-B791-5,DB2-B7910-3,DB2-B7910-5,DB2-B792,DB2-B793-403,DB2-B795,DB2-B798 class			30V	5V	2	3500	215	215	1800	1800
B830	b830	BROTHER	DB2-B837,DB2-B838 class			30V	5V	2	3000	215	215	1800	1800
BLT	blt	BROTHER	LT2-B841-1,LT2-B841-3,LT2-B841-5,LT2-B842-1,LT2-B842-3,LT2-B842-5,LT2-B845,LT2-B8450,LT2-B8480,LT2-B847,LT2-B848,LT2-B872,LT2-B875,LT2-B8750 class			30V	5V	2	3000	185	185	1000	1000
BLZ	blz	BROTHER	LZ2-B852,LZ2-B853,LZ2-B854,LZ2-B856,LZ2-B857 class			30V	5V	2	3000	185	185	1800	1800
J500	j500	JUKI	DDL-500,DMN-5420NFA-6-WB class			30V	5V	2	5000	200	200	1700	1900
J505	j505	JUKI	DDL-505,DDL-505A,DDL-506,DDL-506A,DDL-506E,DDL-560-5,DDL-5600,DLU-5494NBB-6-WB,PLW-1245-6,PLW-1246-6,PLW-1257-6,PLW-1264-6,PLW-1266-6 class			30V	5V	2	4000	200	200	1700	1900
J555	j555	JUKI	DDL-555-2-2B,DDL-555-2-4B,DDL-555ON,DDL-5570,DDL-5571,DDL-5580 class			30V	5V	2	4000	200	200	1700	1900
JDL	jdl	JUKI	DLD-432-5,DLD-436-5,DLM-5400N-6,DLM-5400-6,DLN-415-5,DLN-5410N-6,DLN-5410-6,DLU-450,DLU-490-5,DLU-491-5,DLU-5490BB-6-OB,DLU-5490BB-6-WB,DLU-5490N-6,DMN-530-5,DMN-531-5 class			30V	5V	2	4200	200	200	1700	1900
JDU	jdu	JUKI	DNU-241H-5,DNU-241H-6,DSC-244-6,DSC-244V-6,DSC-245-5,DSC-245-6,DSC-246-6,DSC-246V-6,DSU-142-6,DSU-144-6,DSU-145-5,DSU-145-6,DU-141H-4,DU-141H-5,DU-141H-6,DU-161H-6 class	30V	5V	2	2000	200	200	1700	1900		

13. Simple Setting of Program Mode [3] (for lock stitch trimming machine)

Function	Digital display	Sewing machine maker	Model name of sewing machine and device	I/ O signals of connectors	Junction wiring	Note 1 solenoid voltage	Note 2 DCSV or 12V setting In option A connector	1/ 2 pos	High speed H	Low speed L	Trimming speed T	*Start condensed speed N	End condensed speed V	
JLH	JLH	JUKI	LH-1172,LH-1180-5,LH-1182-5,LH-1150,LH-1152,LH-1160,LH-1162 class	Refer to "HOW TO USE WITH OTHER MANUFACTURER'S MACHINE".	Refer to "HOW TO USE WITH OTHER MANUFACTURER'S MACHINE".	30V	5V	1	2300	200	200	1700	1900	
JLU1	JLU1	JUKI	DDL-5560NL-6,LU-1114-5,LU-1114-6,LZH-1290-6 class			30V	5V	2	2800	200	200	1700	1900	1900
JLU2	JLU2	JUKI	LU-2210-6-0B class			30V	5V	2	3500	200	200	1700	1900	1900
T100	T100	TOYOTA	AD1012,AD1012B,AD1012G,AD1013,AD1013A,AD1013G,AD1020,AD102,AD1102B,AD1102G,AD1103,AD1103A,AD1202,AD1203,AD1204S,AD1205,AD1205S,AD1212G,AD1213,AD2200,AD5010S class			30V	12V	2	3500	200	200	1700	1700	1700
T157	T157	TOYOTA	AD157,AD157G class			30V	12V	2	4000	200	200	1700	1700	1700
T158	T158	TOYOTA	AD158,AD158-2,AD158-22,AD158A-3,AD158A-32,AD158B-2,AD158B-22,AD158G-2,AD158G-22,AD158-3,AD158-32 class			30V	12V	2	3500	200	200	1700	1700	1700
T300	T300	TOYOTA	AD3110,AD3110P,AD320-2,AD320-22,AD320-202,AD331,AD3310,AD3310P,AD332,AD340-2,AD340-22,AD340-202,AD340B-2,AD340B-22,AD340B-202,AD341-2,AD341-22,AD341-202,AD345-2,AD345-22,AD345-202,AD352 class	30V	12V	2	1900	200	200	1700	1700	1700		
U639	U639	UNION SPECIAL	Class 63900 Solenoid-operated needle feed under trimmer	Fig.23	----	30V	12V	2	4000	250	180	1700	1700	
SLH2	SLH2	SEIKO	SLH-2B	----	----	24V	12V	2	570	100	100	1700	1700	
457G	457G	SINGER	457 Wiper	Fig.24	Fig.61	24V	12V	2	4000	250	160	1500	1500	
457F	457F	SINGER	457 Thread pull	Fig.24	Fig.61	24V	12V	2	4000	250	160	1500	1500	
591	591	SINGER	591, 1591	Fig.24	Fig.61	24V	12V	2	4000	250	200	1500	1500	
211A	211A	SINGER	211A	Fig.24	Fig.61	24V	12V	2	2300	200	180	1000	1000	
212A	212A	SINGER	212A	Fig.24	Fig.61	24V	12V	2	3500	200	180	1000	1000	
411U	411U	SINGER	411U	Fig.24	Fig.61	24V	12V	2	4000	250	180	1500	1500	
412U	412U	SINGER	412U	Fig.24	Fig.61	24V	12V	2	4500	250	180	1500	1500	
591V	591V	SINGER	591V	Fig.24	Fig.61	24V	12V	2	4000	250	200	1500	1500	
691A	691A	SINGER	1691D250	Fig.24	Fig.61	24V	12V	2	4000	250	200	1500	1500	
691B	691B	SINGER	1691D210, 1691D200	Fig.24	Fig.61	24V	12V	2	4000	250	200	1500	1500	

12 How to use Simple setting of Program Mode [2] (for chain stitch trimming machine)

1. How to use the program mode [2]

No.1 To set the functions for chain stitch sewing machine in simple setting
 (Ex. to set for the VC2800, VC3800 class, "YAMATO").....Function setting [YU4]

1) PRESS AND HOLD IN THE DOWN ARROW AND THE C KEY AND THE D KEY

2)

FIRST MACHINE TYPE IN LIST

3)

PRESS THE DOWN ARROW KEY TO SELECT THE MACHINE TYPE

4)

PRESS AND HOLD IN THE D KEY UNTIL THE DISPLAY STOPS FLASHING

5)

6)

NORMAL MODE

12.How to use Simple setting of Program Mode [2] (for chain stitch trimming machine)

2.Simple setting table for chain stitch sewing machine

Function	Sewing machine maker	Model name of sewing machine and device	I/ O signals of connectors	Junction wiring	Note 1 solenoid voltage	Note 2 DC5V or 12V setting In option A connector	Note 3 Logic of thread trimming protection signal S6	Note 4 Setting of switch to increase solenoid return speed	1/ 2 pos	High speed H	Low speed L	Trimming speed T	*Start condensed speed N	End condensed speed V
YU2	YAMATO	VC2600, VC2700 class Solenoid-operated under thread trimmer	Fig.1	Fig.50	30V	12V	Sewing machine stops when switch:open	*Note 6	2	6000	200	200	1400	1400
YU3	YAMATO	VC2600, VC2700 class Air-operated under thread trimmer with air wiper	Fig.1	Fig.50	30V	12V			2	6000	200	200	1400	1400
YU4	YAMATO	VC3845P,2845P,2840P class Air-operated under thread trimmer with air wiper	Fig.1	Fig.50	30V	12V			2	6000	200	200	1400	1400
YU5	YAMATO	Solenoid-operated under thread trimmer with solenoid wiper	Fig.1	Fig.50	30V	12V			2	6000	200	200	1400	1400
NO1	PEGASUS	W500, 600, 700 / UT207, UT434 Solenoid-operated under thread trimmer with solenoid wiper without top cover thread trimmer	Fig.4	Fig.53	24V	5V	Sewing machine stops when switch:open		1	6000	200	200	1400	1400
NO2	PEGASUS	W500, 600, 700 / UT207, UT434 Solenoid-operated under thread trimmer with solenoid wiper and top cover thread trimmer	Fig.4	Fig.53	24V	5V			2	6000	200	200	1400	1400
NO3	PEGASUS	W500, 600, 700 / UT103, 104, 109, 111 Solenoid-operated under thread trimmer with solenoid wiper without top cover thread trimmer FX series	Fig.4	Fig.53	24V	5V			1	4500	200	200	1400	1400
NO4	PEGASUS	UT335 Super tack solenoid-operated under thread trimmer with air wiper	Fig.4	Fig.54	24V	5V			1	4000	200	200	1400	1400
NO5	PEGASUS	----	Fig.5	----	24V	5V			1	6000	200	200	1400	1400
NO6	PEGASUS	W562-82UT Angled stitch	Fig.5	Fig.53	24V	5V			2	6000	200	200	1400	1400
NO7	PEGASUS	W600 / UT / MS Solenoid-operated under thread trimmer with solenoid wiper and condensed stitch, without top cover thread trimmer	Fig.6	Fig.53	24V	5V			1	6000	200	200	1400	1400
NO8	PEGASUS	W600 / UT / MS Solenoid-operated under thread trimmer with solenoid wiper and condensed stitch and top cover thread trimmer	Fig.6	----	24V	5V			2	6000	200	200	1400	1400
NOB	PEGASUS	----	Fig.7	----	24V	5V			1	8000	200	200	1400	1400
NOC	PEGASUS	----	Fig.8	----	24V	5V			1	4000	200	200	1400	1400
KA1	KANSAI	M, RX series Automatic thread trimmer with solenoid wiper	Fig.9	Fig.55	24V	12V			2	6000	250	250	1400	1400
KA2	KANSAI	D series Automatic thread trimmer with air wiper	Fig.9	Fig.55	24V	12V			2	6000	250	250	1400	1400
KA3	KANSAI	F series Air-operated under thread trimmer with air wiper	Fig.10	Fig.55	24V	12V	2	6000	250	250	1400	1400		
KA4	KANSAI	DX series Air-operated under thread trimmer with air wiper	Fig.9	Fig.55	24V	12V	2	6000	250	250	1400	1400		

Function	Sewing machine maker	Model name of sewing machine and device	I/ O signals of connectors	Junction wiring	Note 1 solenoid voltage	Note 2 DC5V or 12V setting In option A connector	Note 3 Logic of thread trimming protection signal S6	Note 4 Setting of switch to increase solenoid return speed	1/ 2 pos	High speed H	Low speed L	Trimming speed T	*Start condensed speed N	End condensed speed V
UN1	UNION SPECIAL	33700, 34500 class Solenoid-operated under thread trimmer	Fig.11	Fig.56	30V	12V	Sewing machine stops when switch:open	Always set J1 : SLOW J2 : FAST J7 : SLOW	2	4000	200	200	1400	2999
UN2	UNION SPECIAL	34800skcc class Solenoid-operated under thread trimmer	Fig.12	Fig.56	30V	12V			2	5500	200	200	1400	2999
UN3	UNION SPECIAL	34700 class Push and Pull air-operated under thread trimmer with air wiper	Fig.12	Fig.57	30V	12V			2	4000	200	200	1400	2999
U345	Do not use !!													
U346	Do not use !!													
U348	Do not use !!													
U347	Do not use !!													
BR1	BROTHER	FD3, FD4 series	Fig.13	----	24V	5V	Sewing machine stops when switch:short	*Note 6	2	6000	200	200	1400	1400
RM1	RIMOLDI	----	Fig.14	----	24V	5V			1	6000	200	200	1400	1400
SRB1	SIRUBA	----	Fig.15	----	24V	5V			2	6000	200	200	1700	1700
JMH	JUKI	MH-481-4-4, MH-484-4-4 class	Fig.16	----	30V	5V			2	5500	200	200	1700	1900

MOST COMMONLY USED FUNCTIONS IN THE P AND A MODES

P-MODE

PRESS AND HOLD IN THE ↓ + ↑ ARROW KEYS UNTIL THE DISPLAY STOPS FLASHING

- H HIGH SPEED (0-8999)
- T TRIM SPEED (0-499)
- N START BACKTACKING SPEED (0-2999)
- V END BACKTACKING SPEED (0-2999)
- M MEDIUM SPEED (0-8999)
- PSU MACHINE STOP WITH NEEDLE UP AND TRIM WITH SENSOR (0-99)
- PSD MACHINE STOP WITH NEEDLE DOWN AND NO TRIM WITH SENSOR (0-99)
- FUM PRESSER FOOT REMAINS UP AFTER TRIM (OF/ON)
- S6L INTERNAL THREAD TRIMMER SAFETY CIRCUIT (HI/LO)
- AT CANCEL VARIABLE SPEED WITH TREADLE (OF/ON)
- RU REVERSE AFTER TRIM (OF/ON)
- R8 DEGREE OF REVERSE AFTER TRIM (0-360)

MOST COMMONLY USED FUNCTIONS IN THE A-MODE

A-MODE

PRESS AND HOLD IN THE ↓ + A KEYS UNTIL THE DISPLAY STOPS FLASHING

- GA TORQUE GAIN FOR SEWING MACHINE (H, L, LL) HIGH, LOW, VERY LOW
- BK WEAK BREAK AFTER STOP (OF/ON)
- BKM BRAKE FORCE (E, H) E=LIGHT BRAKE H=STRONG BRAKE

MOST COMMONLY USED FUNCTIONS IN THE J AND R-MODES

J-MODE

PRESS AND HOLD IN THE ↓ + ↑ + A + B KEYS UNTIL THE DISPLAY STOPS FLASHING

PSW PANEL LOCK OUT (OF/ ON)

R-MODE (CONTROL BOX RESET)

R-MODE

1. PRESS AND HOLD IN THE ↓ + B + C KEYS UNTIL THE DISPLAY STOPS FLASHING
2. PRESS AND HOLD IN THE D-KEY UNTIL THE DISPLAY STOPS FLASHING

3.Points of Caution

7. A high voltage is applied inside the machine, so wait 10 minutes after turning the power switch OFF before opening the cover.

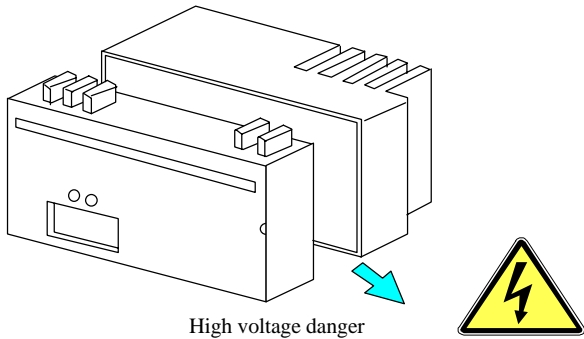

8. Use the machine away from sources of strong noise such as a high frequency welder.

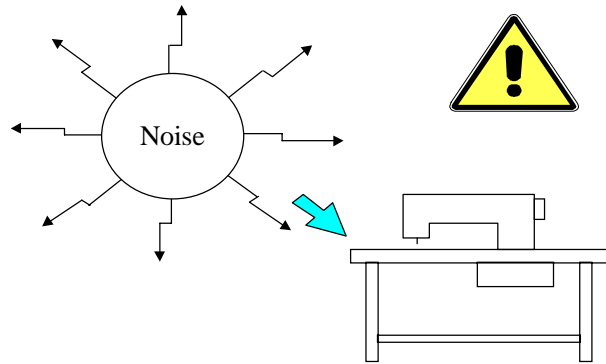

9. The brakes may not function when the power is turned OFF or when there is a power failure during sewing machine operation.

10. Match the connector shape and direction, and insert securely.

11. An optical method is used for the detector's detection element so take care not to let dust or oils get on the detection plate when removing the cover for adjustment, etc. If these do get on the plate, wipe off with a soft cloth and do not scratch the plate. Take care not to let oils enter between the detector discs.

12. When the position detector connector or the belt has come off or when the sewing machine is completely locked, the motor will be automatically turned OFF after a set time to prevent damage to the motor. (The motor may not turn OFF if the locking is not complete.) After the problem has been resolved, turn the power OFF and ON and normal operation will be possible. The same operation should be taken when the detector or wires are broken.

...

13. Remove the dust that has adhered on the motor's dust-proof filter once every two to three weeks.

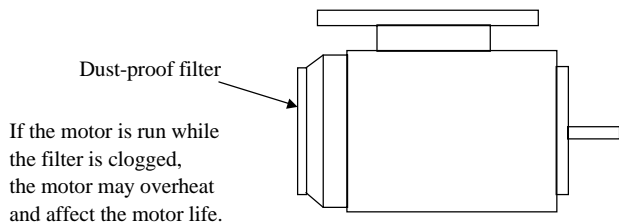

14. When connecting the external switch to the option connector, etc., keep the signal wire as short as possible. If it is long, malfunctions may occur.

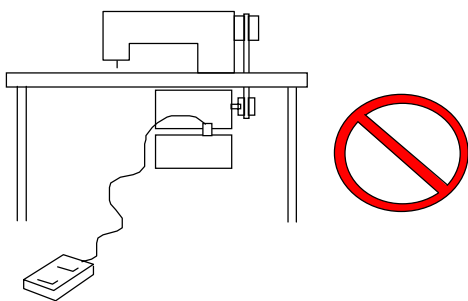

- Use a shield cable for the signal wire when possible.

15. If the fuse blows, remove the cause, and replace the blown fuse with one having the same capacity.

220V Two fuses
110V One fuse

Two 20A Fuses (XC-EN, EMFY)

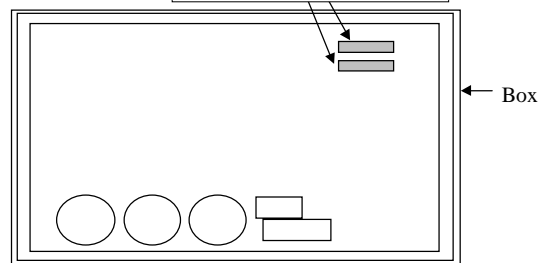

(Front view with cover removed.)

- The above fuses is for protection of the control box power supply section.

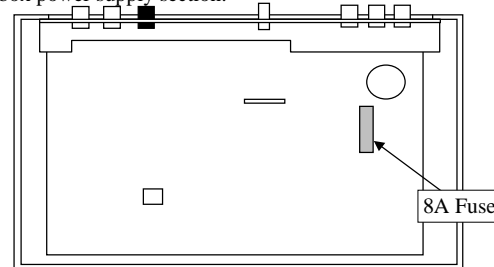

(View from back of cover.)

- The above 8A fuse is for protection of the solenoid output power supply (24V) section..



Wait 10 minutes after turning the power switch OFF before opening the cover

7. Wire and Grounding

4. When using the 3-phase 200V class Limiservo X with single phase 200~220V class

- Connect the "red" and "white" lead wires from the push-button switch to the power.G
The black wire is not used.
Tape it with insulation tape, etc., to insulate securely.
Always ground the green/ yellow (green) grounding wire.

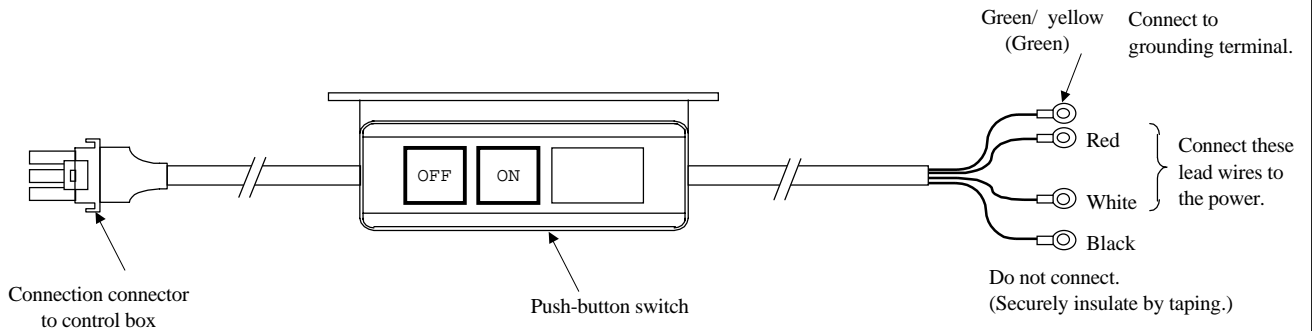

5. When using the 3-phase 200~220V Limiservo X with 3-phase 220V~240V

- (1) Remove the cover.
- (2) Reconnect the connector from [CON5] to [CON 6] (220-240V).
- (3) After change, always set the cover of control box.
- (4) Change the nameplate on the control box

(XC-EMFY Control box only)

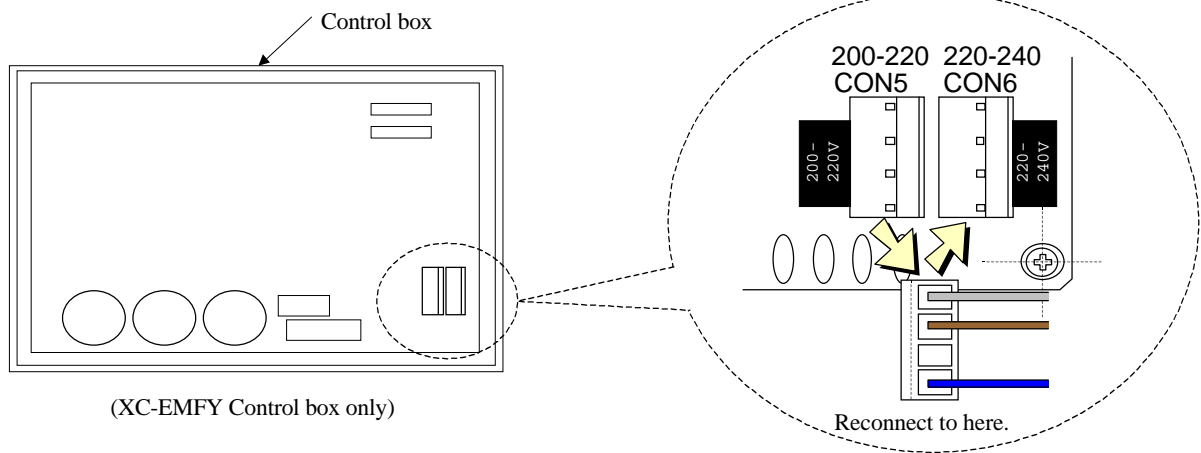

For safety, turn the power switch OFF before opening cover.

6. To change solenoid voltage

(XC-EMFY Control Box only)

To change solenoid voltage from 24V to 30V.

- (1) Remove the cover.
- (2) Reconnect the connector from [CON11] to [CON12] (30V).
- (3) After change, always set the cover to the control box.

To change solenoid voltage from 30V to 24V.

- (1) Remove the cover.
- (2) Reconnect the connector from [CON12] to [CON11] (24V).
- (3) After change, always set the cover to the control box.

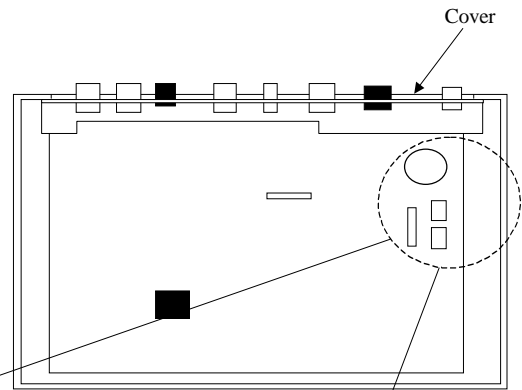

From 24V to 30V

From 30V to 24V

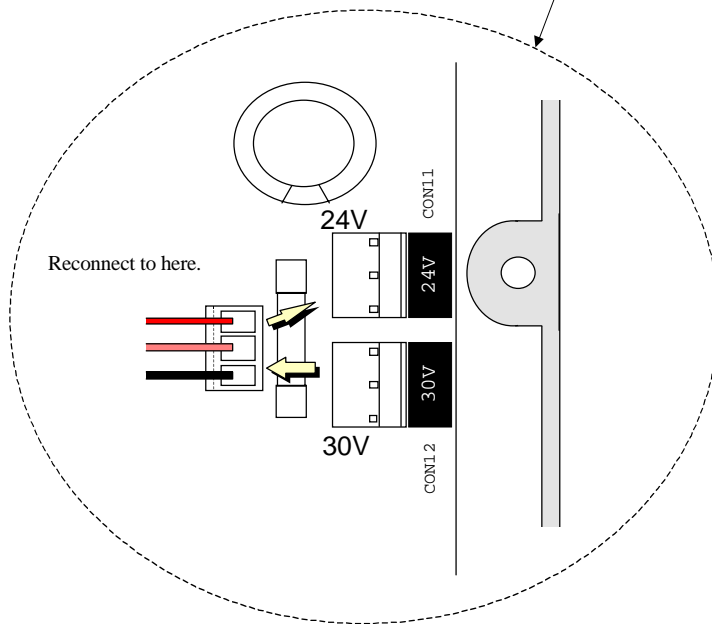
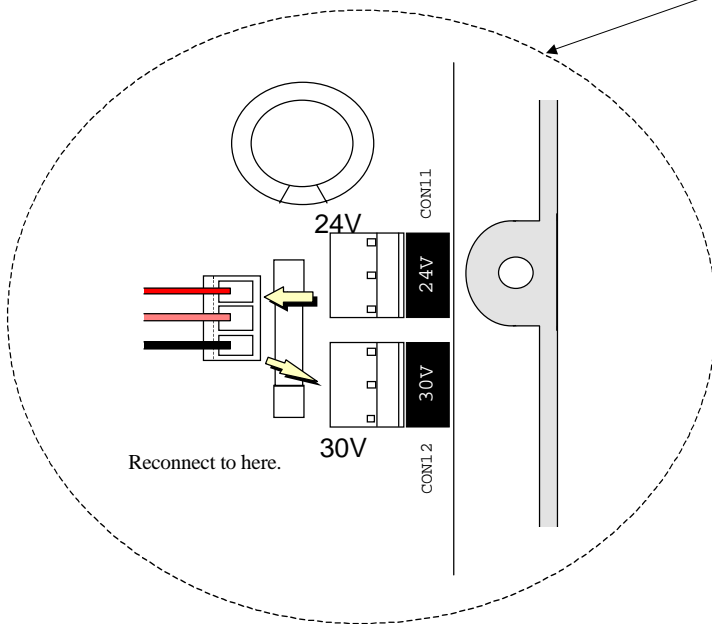

For safety, turn the power switch OFF before opening cover.

1. To change Solenoid voltage 24V/30V. (Refer to page 17.)

2. How to change the output voltage DC5V/12V

(1) Remove the cover.



Caution : Wait over 10 minutes after turning the power switch OFF before opening cover.

(2) The DC5V/ 12V can be changed with the J2, J6, J7, J10 and J11 connector on the printed circuit board on the cover side as shown next page.

(3) This is set to 12V when shipped from the factory. To change from 5V to 12V, pull out the connector and reinsert it into the 5V side.

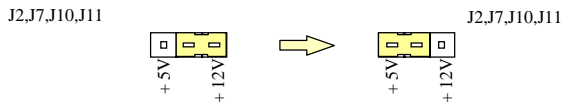

This is set to 5V when shipped from the factory. To change from 12V to 5V, pull out the connector and reinsert it into the 12V side.

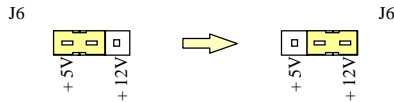

(4) The power supply (+ 12V) voltage will change form 12V to 5V by changing the J10 connector from 12V to 5V.

Position detector

0V	1
----	2
Ground	3
UP	4
DOWN	5
+ 12V/ (+ 5V)	6

(5) The power supply (+ 12V) voltage will change form 12V to 5V by changing the J11 connector from 12V to 5V.
(When wanting to make change gears of the sewing machine possibly at variable speed command of 5 V, set the setting value of pedal curve function setting <PDC> by the A mode.)

Lever (white connector)

0V	1	
S1 : Run (Variable speed)	IG	2
S2 : Tread trimming	IH	3
S3 : Presser foot lifter	II	4
VC : Variable speed command		5
+ 12V		6

...12V ==> 5V

(6) The power supply (+ 12V) voltage will change form 12V to 5V by changing the J7 connector from 12V to 5V.

Option A

0V	1	
PSU: Up position stop input	IA	2
+ 12V		3
PSD: Down position stop input	IB	4
CKU : Up position output		5
S0: Low speed input	IC/ CKD	6

...12V ==> 5V

...12V ==> 5V

21.How to change voltage of panel connector and solenoid return speed

- (7) The output of pin number 2, 5, 13, 14 will change from 12V to 5V by changing the J2 connector from 12V to 5V, also the power supply (+ 5V : Pin number 7) voltage will change from 5V to 12V by changing the J6 connector from 5V to 12V.

Option B

0V		1	
No setting	O4/ I4	2	...12V ==> 5V
OT1 : Virtual output	O1	3	
VC2 : Variable speed command		4	
No setting	O5/ I5	5	...12V ==> 5V
IO1:Virtual input	I1	6	
+ 5V		7	...5V ==> 12V
+ 30V		8	
U: Needle lift signal	I2	9	
0V		10	
+ 30V		11	
NCL : Needle cooler output	O2	12	
No setting	O7/ I7	13	...12V ==> 5V
No setting	CP/ O6/ I6	14	...12V ==> 5V
TF : "TF" output	O3	15	

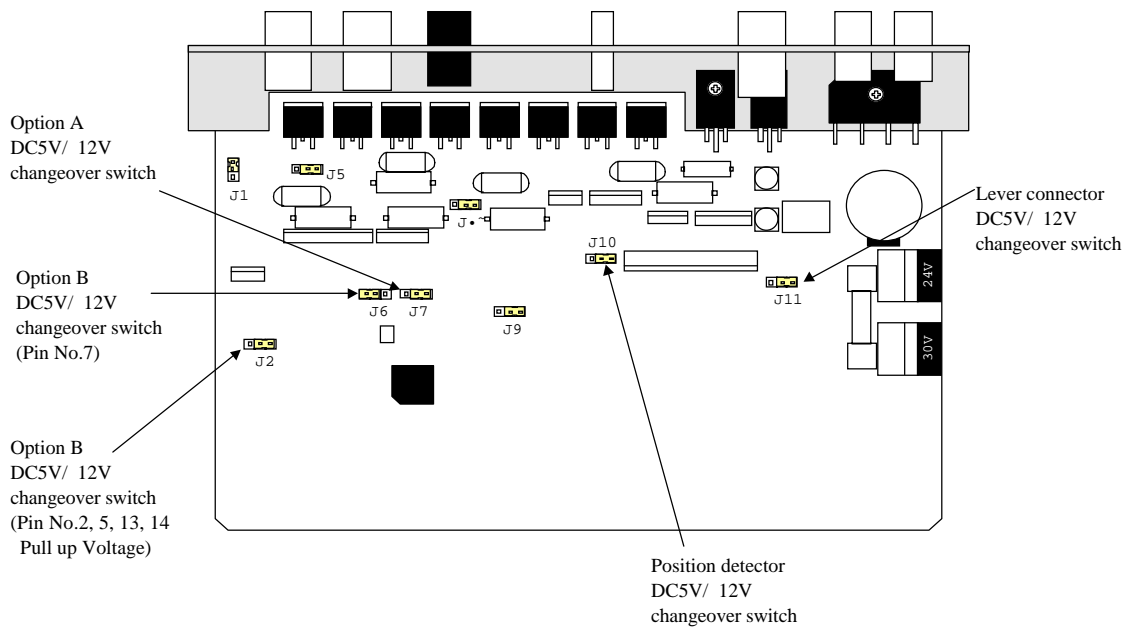

21.How to change voltage of panel connector and solenoid return speed

3. How to set the switch for increasing the solenoid return speed.

(1) Remove the cover.



Caution : Wait over 10 minutes after turning the power switch OFF before opening cover.

(2) The solenoid return speed can be increased with the setting of the J1, J5, J8 connector on the printed circuit board on the cover side as shown on the last page.

(3) Connector factory settings and solenoid return

Connector	Connector factory setting	Output during simple setting	Solenoid return	Output
J1	FAST	Sewing machine connector 11-12 pin output.	Fast	OC
J5	SLOW	Sewing machine connector 3-4 pin output.	Normal	OA
J8	SLOW	Sewing machine connector 7-8 pin output.	Normal	OD

(4) Set the connector setting from SLOW to FAST increase the solenoid return speed.



Caution

The solenoid return speed cannot be increased if solenoid output chopping duty

OAC, ODC and O3C is return ON in the program mode [C].

The resistance on the printed circuit board will be burnt out if the solenoid return speed is increased.

This connector must always be turned ON.

If "UNION SPECIAL" [UN1], [UN2] and [UN3] are set in program mode [2], always use J1 and J8 set at SLOW (solenoid return is normal), J5 set at FAST (solenoid return is fast).

TROUBLESHOOTING

LOCATED IN THE E-MODE

PRESS AND HOLD IN THE ↓ + ↑ + A KEYS UNTIL THE DISPLAY STOPS FLASHING

ERROR CODES

- 1 LAST ERROR CODE
- 2 SECOND TO LAST ERROR CODE
- 3 THIRD TO LAST ERROR CODE
- 4 FOURTH TO LAST ERROR CODE

POWER DURATION

- P POWER ON TIME X 10
- M MOTOR ON TIME X 10

INPUT SWITCHES

- IG RUN INPUT
- IH TRIMMER INPUT
- II PRESSER FOOT INPUT

DRIVE MOTOR

- ECA MOTOR ENCODER A-PHASE
- ECB MOTER ENCODER B-PHASE

SYNCHRONIZER

- UP SYNCHRONIZER UP POSITION
- DN SYCHRONIZER DOWN POSITION

VARIABLE RESISTERS

- PD VC1 (TREADLE UNIT)
- VC VC2 (VARIABLE RESISTOR ON 4710/4730)

SOLENOID OUTPUTS (PRESS THE D-KEY TO CHECK)

- OA0 TRIMMER
- OBO WIPER
- OCO BACKTACK
- ODO TENSION RELEASE
- OFO PRESSER FOOT

OTHER

- TP TYPE OF CONTROL BOX
- T DISPLAY OF CURRENT MACHINE TYPE SELECTED

Error code	Probable cause	Inspection
<i>P8r.of</i>	8A fuse in control box broken. Is the power voltage too low? Is the power supply capacity too small? <div style="border: 1px solid black; padding: 5px; margin: 5px 0;">Note : It does this display when power supply is turned OFF, but this is not an error.</div>	Replace the 8A fuse. Check the power voltage. Check the power supply capacity.
E1	Is the wire to the motor short-circuited? Is the sewing machine load torque too high?	Check the motor wiring. Check the sewing machine.
E2	Is the power voltage too high? Is the sewing machine inertia too high?	Check the power voltage. Lengthen the deceleration time. (Refer to DC in [A] mode.)
E3	Is the connector to the motor encoder securely inserted? Are the signals from the motor encoder correct? Is the sewing machine locked? Is the motor locked?	Check the connector insertion. Check the encoder signals. (Refer to [E] mode.) Check the sewing machine. Check the motor.
E4	Is the motor connector securely inserted? Are the signals from the motor connector correct?	Check the motor connector insertion. Check the motor connector.
E6	Is an extraordinary signal inputted? (The signal as it repeats ON/ OFF at the high frequency.) Does the noise from outside enter an input signal.	Check the input signal. Removes a noise source.
E8	Is the position detector connector securely inserted? Are the signals from the detector correct? (UP/ DOWN signal interruption)	Check the detector connector insertion. Check the detector UP/ DOWN signals. (Refer to [E] mode.)
E9	Is the solenoid wiring short-circuited? Solenoid defect (coil defect)	Check the solenoid wiring. Replace the solenoid.
M5	A error of the copy mode using the control panel. Is the control panel connector securely inserted? The voltage or the type of control panel is difference.	Check the connector insertion. Check the voltage and the type are right.

Others	Probable cause	Inspection
The sewing does not run when the pedal pressed.	Is the lever unit connector securely inserted? Are the operation signals (S1) from the lever unit broken?	Check the lever unit connector insertion. Check the lever unit signal. (Refer S1 signal, [E] mode.)
The sewing machine does not run at the high speed.	It does not displayed 99 in normal mode. Is the variable speed voltage with the pedal toed down low? Is the motor pulley diameter too small?	Change 99 using control box [D] key. Check the variable speed voltage. (Refer to [E] mode.) Check the motor pulley diameter. (Refer item 9.3.)
The thread is not trimmed even with heeling.	Is the thread trimming signal (S2) from the lever unit broken? Is the cancel thread trimmer operation S2L ON?	Check the signal S2. (Refer [E] mode.) Set S2L to OFF. (Refer [P] mode.)
The presser foot lifter output does not operate.	Is the light heeling signal (S3) or the thread trimming signal (S2) from the lever unit broken? Is the presser foot lift signal (F) broken? Is the presser foot output (FU) broken?	Check signals S2 and S3. (Refer [E] mode.) Check signal F. (Refer [E] mode.) Check FU output. (Refer [E] mode.)

OPTION CONNECTORS FOR XC-EMFY

LEVER

SIGNAL NAME	FACTORY SETTING	PIN
0V	0V	1
IN-G	S1 : Run (Variable speed)	2
IN-H	S2 : Thread trimming	3
IN-I	S3 : Presser foot lifter	4
VC	VC : Variable speed command	5
+ 12V(5V)	+ 12V	6

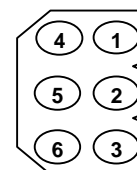

PRESSER FOOT

0V	0V	1
IN-F	F : presser foot input	2
OUT-F	FU+ : presser foot lifter output +	3
OUT-F	FU- : presser foot lifter output -	4

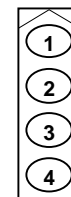

SEWING MACHINE

Ground	Ground	1
OUT-B	W : Wiper output	2
+ 24V/ + 30V	+ 24V/ + 30V	3
OUT-A	T : Thread trimming output	4
0V	0V	5
IN-D	TL : Thread trimmer cancel input	6
OUT-D	L : Thread release output	7
+ 24V/ + 30V	+ 24V/ + 30V	8
IN-E	S7 : Backstitch input	9
0V	0V	10
+ 24V/ + 30V	+ 24V/ + 30V	11
OUT-C	B : Backstitch output	12

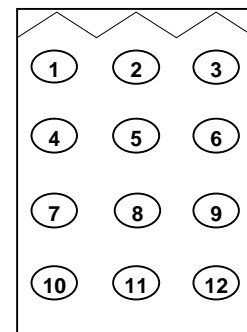

OPTION A

0V	0V	1
IN-A	PSU: Up position stop input	2
+ 12V(+ 5V)	+ 12V	3
IN-B	PSD: Down position stop input	4
CKU	CKU : Up position output	5
IN-C/(CKD)	S0: Low speed input	6

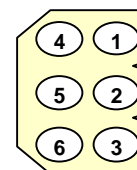

OPTION B

0V	0V	1
OUT-4/ IN-4	No setting	2
OUT-1	OT1 : Virtual output	3
VC2	VC2 : Variable speed command	4
OUT-5/ IN-5	No setting	5
IN-1	IO1:Virtual input	6
+ 5V(12V)	+ 5V	7
+ 24V/ + 30V	+ 24V/ + 30V	8
IN-2	U: Needle lift signal	9
0V	0V	10
+ 24V/ + 30V	+ 24V/ + 30V	11
OUT-2	NCL : Needle cooler output	12
OUT-7/ IN-7	No setting	13
CP/ OUT-6/ IN-6	No setting	14
OUT-3	TF : "TF" output	15

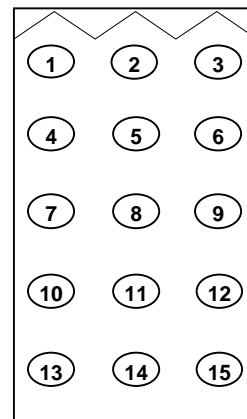

NOTE: PIN NUMBER 3, 12, AND 15 ARE FOR SOLENOID OUTPUT.

OPTION CONNECTORS FOR XC-EMFY

LEVER

SIGNAL NAME	FACTORY SETTING	PIN
0V	0V	1
IN-G	S1 : Run (Variable speed)	2
IN-H	S2 : Thread trimming	3
IN-I	S3 : Presser foot lifter	4
VC	VC : Variable speed command	5
+ 12V/ (5V)	+ 12V	6

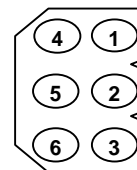

PRESSER FOOT

0V	0V	1
IN-F	F : presser foot input	2
OUT-F	FU+ : presser foot lifter output +	3
OUT-F	FU- : presser foot lifter output -	4

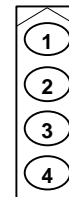

SEWING MACHINE

Ground	Ground	1
OUT-B		2
+ 24V/ + 30V	+ 24V/ + 30V	3
OUT-A		4
0V	0V	5
IN-D		6
OUT-D		7
+ 24V/ + 30V	+ 24V/ + 30V	8
IN-E		9
0V	0V	10
+ 24V/ + 30V	+ 24V/ + 30V	11
OUT-C		12

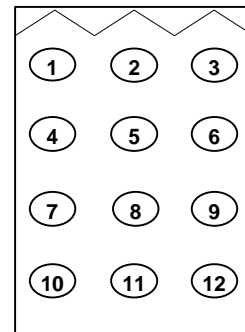

OPTION A

0V	0V	1
IN-A		2
+ 12V/ (+ 5V)	+ 12V	3
IN-B		4
CKU		5
IN-C/ (CKD)		6

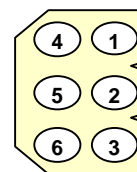

OPTION B

0V	0V	1
OUT-4/ IN-4		2
OUT-1		3
VC2	VC2 : Variable speed command	4
OUT-5/ IN-5		5
IN-1		6
+ 5V(12V)	+ 5V	7
+ 24V/ + 30V	+ 24V/ + 30V	8
IN-2		9
0V	0V	10
+ 24V/ + 30V	+ 24V/ + 30V	11
OUT-2		12
OUT-7/ IN-7		13
CP/ OUT-6/ IN-6		14
OUT-3		15

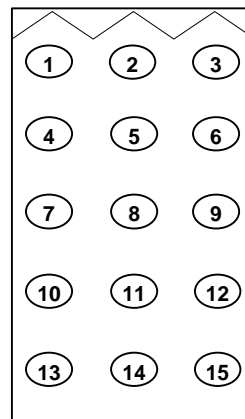

NOTE: PIN NUMBER 3, 12, AND 15 ARE FOR SOLENOID OUTPUT.

HOW TO TURN ON AN OUTPUT AT TREADLE TOE DOWN

THE CONTROL BOX IS ALREADY SET UP TO DO THIS FUNCTION WITHOUT ANY CHANGES

FOR THE WIRING, PUT THE 2 WIRES FROM THE SOLENOID YOU ARE USING INTO PINS 11 AND 12 ON THE OPTION B PLUG.

REFER TO THE CONNECTOR LAY-OUT PAGE

HOW TO WIRE UP A SENSOR TO STOP THE MOTOR

THE INPUTS ON THE CONTROL BOX ARE A SINKING TYPE, MAX. 40MA, 5 OR 12 VDC

ALL SENSORS WILL USUALLY HAVE 3 WIRES

POWER WILL USUALLY BE A RED OR BROWN WIRE
0-VOLT WILL USUALLY BE A BLACK OR BLUE WIRE
SIGNAL WILL USUALLY BE A WHITE OR BLACK WIRE

MOST SENSORS HAVE THE COLOR CODES AND OPERATING VOLTAGES ON THEM

ON THE OPTION A PLUG

0-VOLT TO PIN 1
SIGNAL TO PIN 2
POWER TO PIN 3

REFER TO THE CONNECTOR LAY-OUT PAGE

IN THE P-MODE, SET PSU TO THE NUMBER OF STITCHES YOU WANT (0-99) UNTIL THE MOTOR STOPS

NOTE: IF THE SENSOR WORKS IN REVERSE, YOU MAY HAVE A LIGHT OR DARK OPERATE MODE SWITCH ON YOUR SENSOR, IF NOT GO TO THE C-MODE (↓ + C) AND CHANGE IAL FROM OF TO ON

BACKUP OF PARAMETER DATA

1. WITH THE POWER OFF, PRESS AND HOLD IN THE ↓- KEY AND THEN POWER UP
 2. PRESS AND HOLD IN THE ↓ + A + B + D- KEYS UNTIL THE DISPLAY STOPS FLASHING
DISPLAY WILL SHOW “BAKUP”
 3. PRESS AND HOLD IN THE D-KEY UNTIL THE DISPLAY STOPS FLASHING
- NOW WHEN DOING A CONTROL BOX RESET, THE BACKED UP PARAMETERS WILL BE READ

XC-E500-Y

TO MAKE THE XC-E500-Y DISPLAY THE SAME AS THE XC-EMFY

1. PRESS AND HOLD THE STEP-KEY

STEP
↓

 THEN PRESS THE F-KEY

F

2. **NOTE:** INPUT LAMP

INPUT

 MUST BE OFF

TO RETURN TO THE NORMAL XC-E500-Y DISPLAY

1. PRESS AND HOLD THE F-KEY

F

 THEN THE STEP KEY

STEP
↓

TO TRANSFER DATA FROM THE XC-EMFY TO THE XC-E500-Y

1. WHILE PRESSING THE ABCD-KEY

ABCD

 TURN ON THE POWER
2. DISPLAY WILL SHOW (READ)
3. PRESS THE F-KEY

F

4. TRANSFER IS COMPLETE WHEN THE NORMAL DISPLAY OF THE XC-E500-Y APPEARS

TO TRANSFER DATA FROM THE XC-E500-Y TO THE XC-EMFY

1. WHILE PRESSING THE N-KEY

↑
N

 TURN ON THE POWER
2. DISPLAY WILL SHOW (WRITE)
3. PRESS THE F-KEY

F

4. TRANSFER IS COMPLETE WHEN THE NORMAL DISPLAY OF THE XC-E500-Y APPEARS

INSTRUCTIONS FOR INSTALLING BACKTACK SWITCH AA-G003-925 ON XC-EMFY CONTROL BOX

INSERT PLUG FROM SWITCH TO OPTION A ON XC-EMFY CONTROL BOX

HOW TO TURN ON THE BACKTACK FUNCTION ON CONTROL BOX

1. FROM THE NORMAL MODE (DISPLAY HAS A ROTATING CIRCLE ABOVE THE M-KEY) PRESS THE UP ARROW KEY 1 TIME

DISPLAY WILL LOOK LIKE THIS

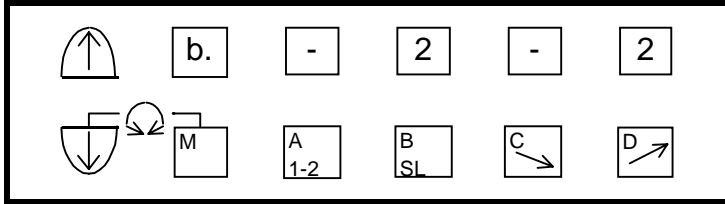

2. PRESS THE A-KEY TO TURN ON THE START BACKTACK

3. PRESS THE C-KEY TO TURN ON THE END BACKTACK

DISPLAY WILL LOOK LIKE THIS

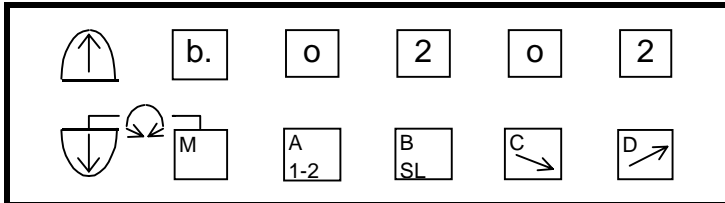

THE A-KEY TURNS ON OR OFF THE START BACKTACK

THE C-KEY TURNS ON OR OFF THE END BACKTACK

THE B-KEY SELECTS THE TYPE OF START BACKTACK

THE D-KEY SELECTS THE TYPE OF END BACKTACK

TYPES OF BACKTACK ARE SINGLE, DOUBLE, TRIPLE, ETC.

4. PRESS UP ARROW KEY 1 TIME

DISPLAY WILL LOOK LIKE THIS

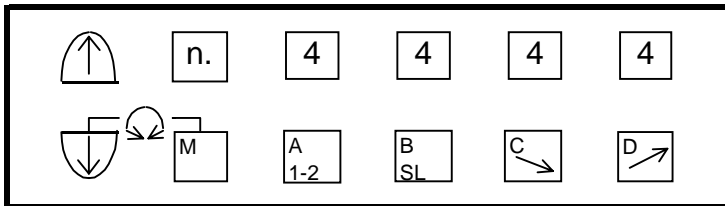

5. USE THE A-KEY AND B-KEY TO SELECT THE AMOUNT OF FORWARD AND REVERSE STITCHES FOR THE START BACKTACK

6. USE THE C-KEY AND D-KEY TO SELECT THE AMOUNT OF FORWARD AND REVERSE STITCHES FOR THE END BACKTACK

7. PRESS THE DOWN ARROW KEY 2 TIMES TO RETURN TO THE NORMAL MODE

FUNCTION SETTINGS FOR BACKTACK SWITCH (LOCATED IN THE C-MODE)

1. PRESS AND HOLD THE DOWN ARROW AND C-KEY FOR 2 OR MORE SECONDS

DISPLAY WILL LOOK LIKE THIS

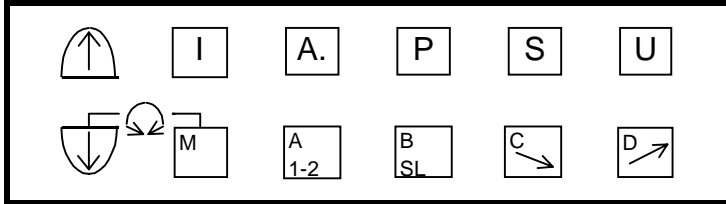

2. USE THE D-KEY TO SELECT S b (START BACK TACK CANCEL)

NOTE: THE D-KEY MOVES FORWARD THROUGH THE LIST OF FUNCTIONS AND THE C-KEY BACKWARDS THROUGH THE LIST OF FUNCTIONS

DISPLAY WILL LOOK LIKE THIS

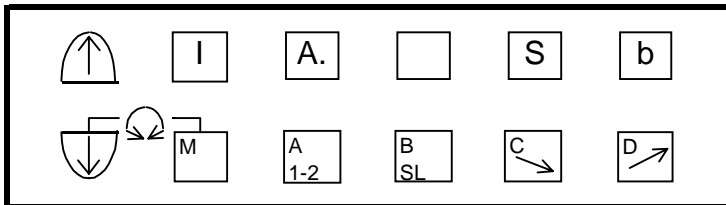

3. PRESS THE DOWN ARROW KEY 3 TIMES

DISPLAY WILL LOOK LIKE THIS

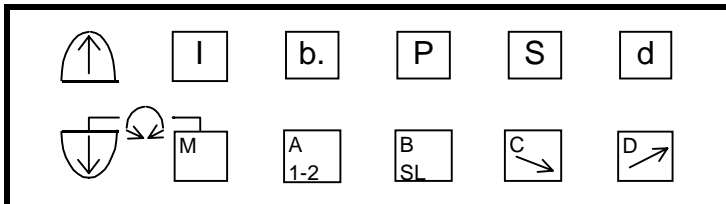

4. USE THE D-KEY TO SELECT E b (END BACKTACK CANCEL)

DISPLAY WILL LOOK LIKE THIS

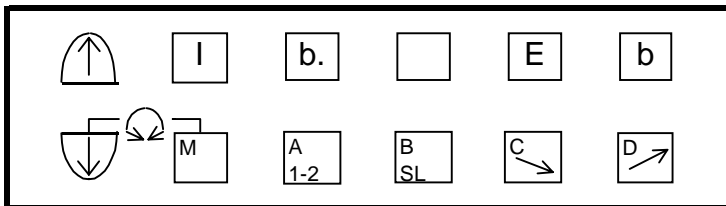

5. PRESS THE DOWN ARROW AND UP ARROW KEYS TO RETURN TO THE NORMAL MODE

1. Input and output customization

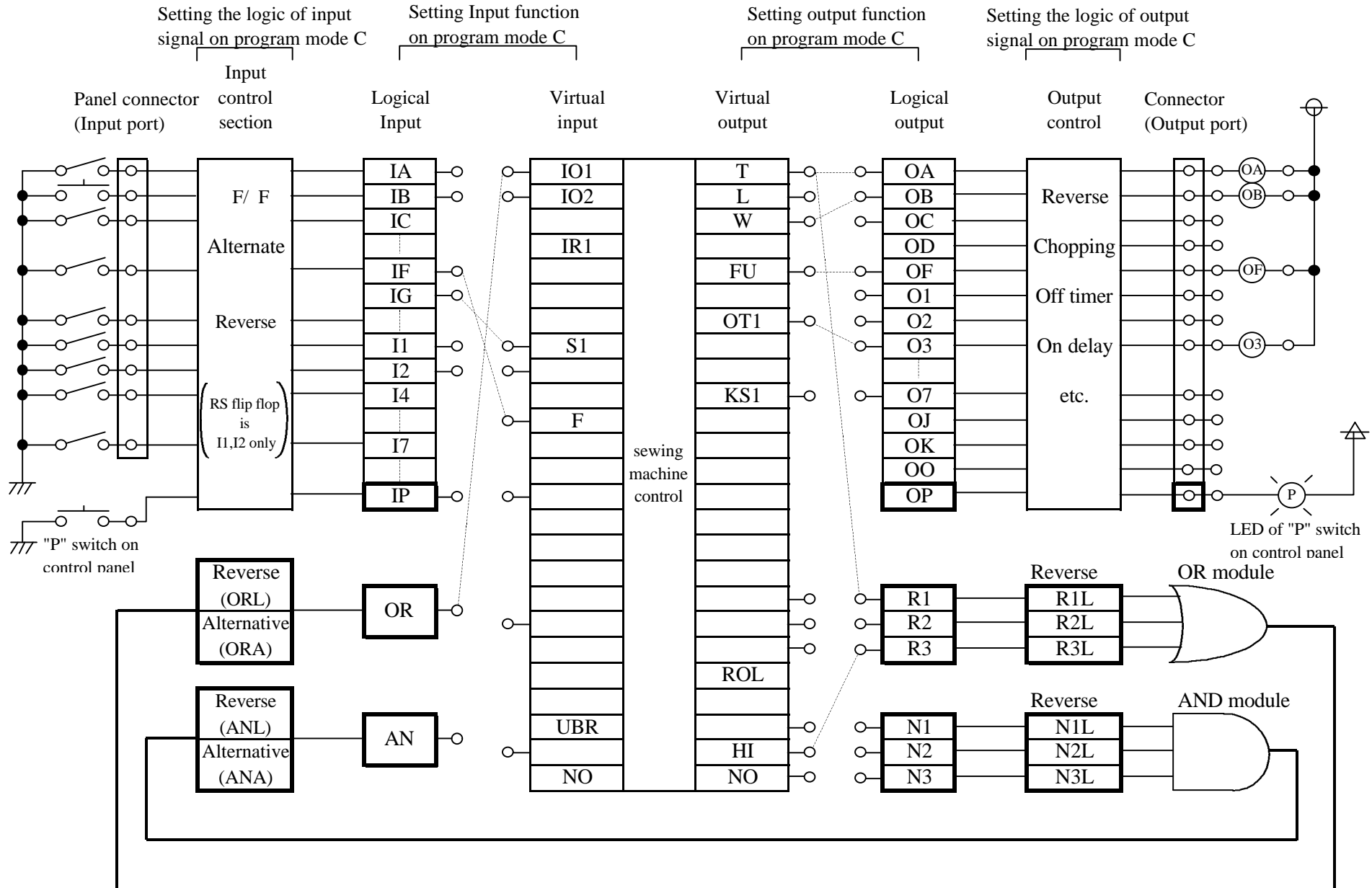

2. Coupling output signal with input inside control unit

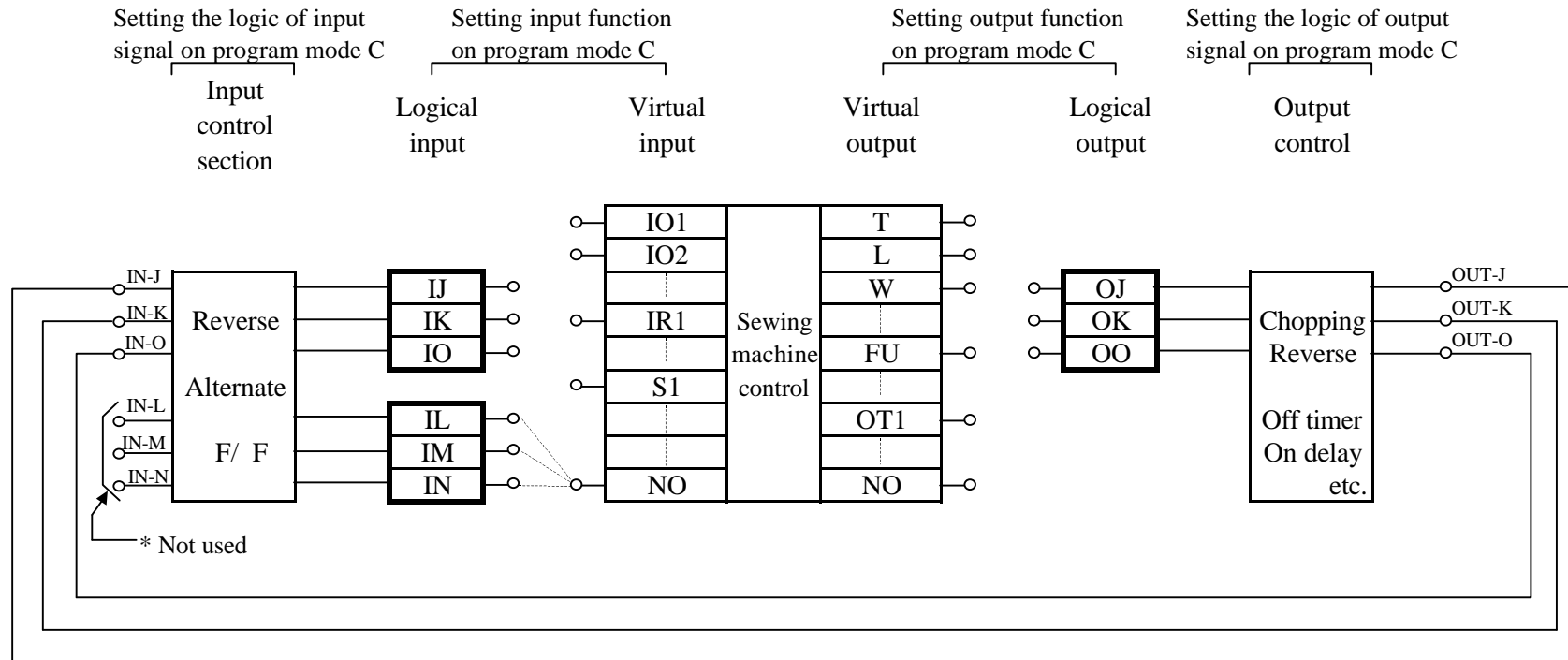

- * The factory settings of the input function settings [IJ], [IK], [IO] and [IL], [IM], [IN] are all [NO].
- * The factory setting of the output function settings [OJ], [OK], [OO] are all [NO].
- * The input function settings [IL], [IM], [IN] must not be used with the default setting [NO].

3. Connector input/output common port

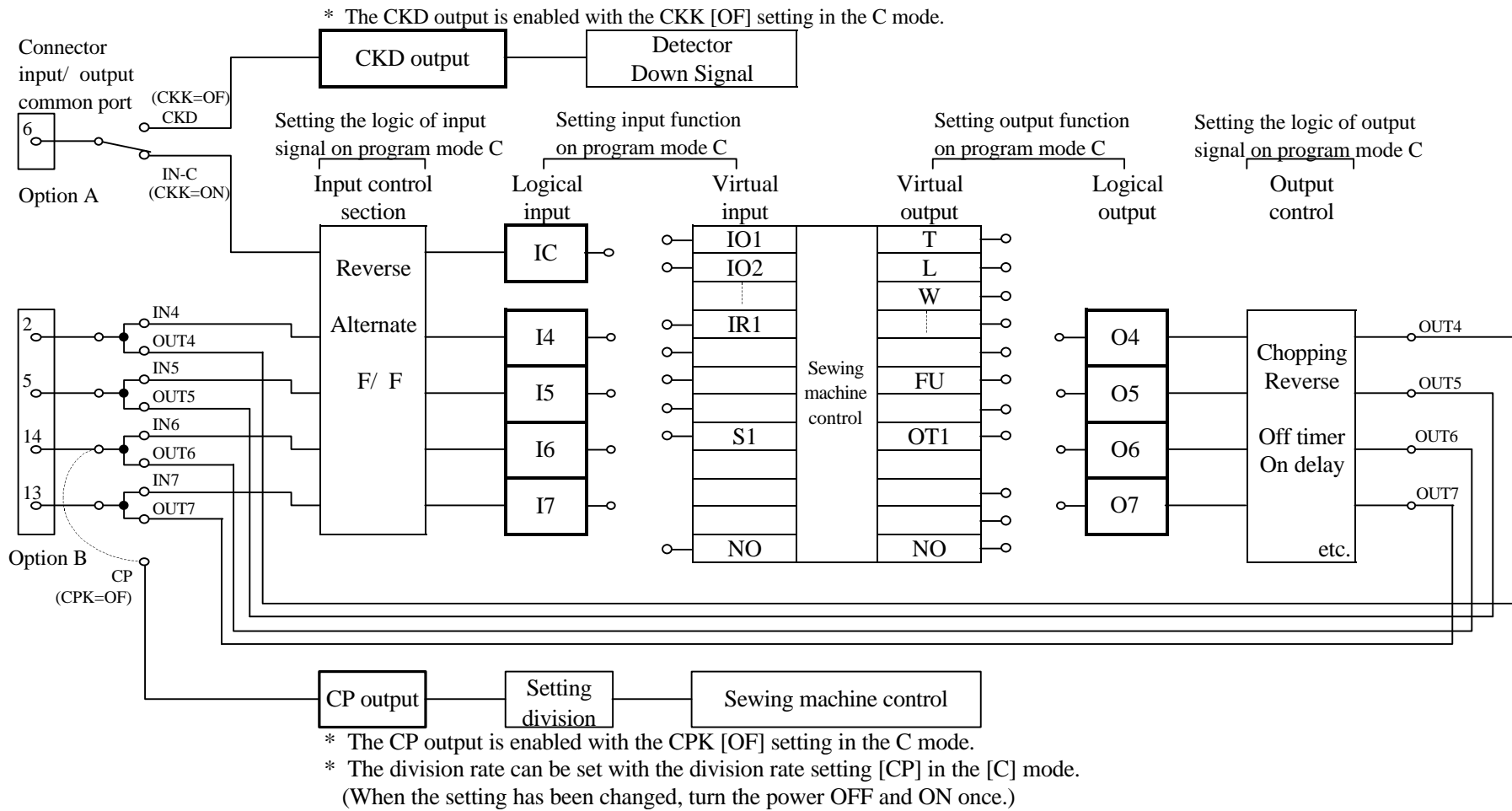

Note) Option B connector input/ output common port

When changing the input/ output, set the output side to [NO] to use the port for inputs and set the input side to [NO] to use the port for outputs. The default settings are all [NO].
 (For example, if the option B connector No. 2 pin is to be set to input, set the OUT4, or [O4] function to [NO], and set the required input function in IN4, or [I4] function.)

The above input/ output common port is connected internally,
 so if a function other than [NO] is set on both the input side and output side, the output side setting will affect the input side.

25 Table of input/ output function for signal on C mode

C mode input signal setting table

EN EMFY

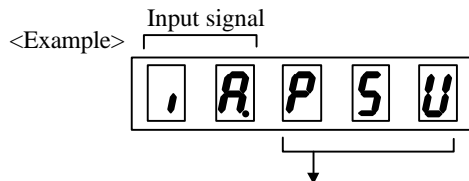

No.	Setting name	Setting value		Specification
			Digital display	
1	Nothing signal	NO	□ □	The sewing machine will do nothing even if input NO is turned ON.
2	Low speed run signal	S0	Ⓢ □	If input S0 is turned ON, the sewing machine will run at the speed set in low speed L.
3	Variable speed run signal	S1	Ⓢ ∷	This signal is equivalent to full toe down when using the pedal. It is operated at the speed which was set with the [C] [D] key of operation panel when the automatic operation AT is ON input S1 at the time of ON.
4	Medium speed run signal	S5	Ⓢ Ⓢ	If input S5 is turned ON, the sewing machine will run at the speed set in medium speed M.
5	High speed run signal	S4	Ⓢ ∷	If input S4 is turned ON, the sewing machine will run at the speed set in high speed H.
6	Stop position random run signal	RND	∷ □ □	If input RND is turned ON, the sewing machine will run at the speed set in low speed L, and when stopping the sewing machine will stop at random regardless of the needle position.
7	Correction stitching signal	COR	∷ □ ∷	If input COR is turned ON, correction stitching will be performed at the speed set in low speed L.
8	Thread trimmer signal	S2	Ⓢ Ⓢ	This signal is equivalent to full heeling when using the pedal. When S2 is ON and thread trimming or needle UP position stop has been completed, the wiper will operate. After that, the automatic presser foot lifting will function while the signal is ON.
9	1 stitch signal	S01	Ⓢ □ ∷	If input S01 is turned ON, 1 stitch operation will start.
10	Needle lift signal	U	∷ ∷	If input U is turned ON, the needle lift operation will start.
11	Half-stitch signal	UD	∷ □	If input UD is turned ON, half-stitch operation will start.
12	Constant angle [reverse run/ forward run] signal	BC	∷ □	The needle is stopped just above the fabric to confirm the fabric puncture position. Each time the signal turns ON, the operation will alternate between forward - reverse - forward run. If the pedal is toed down or the external run signal (S1) turns ON after that, forward run will start from that position. The needle position stop angle can be set with needle position stop angle C8 in the [B] mode.
13	Constant angle [reverse run/ forward run] signal	BCR	∷ □ ∷	The needle is stopped just above the fabric to confirm the fabric puncture position. Each time the signal is turned ON, the operation will alternate between forward - reverse - forward run. If the pedal is toed down or the external run signal (S1) turns ON after stopping at a forward run position, forward run will start after reverse run. If stopped at a reverse run position, the sewing machine will forward run from that position. The needle position stop angle can be set with needle position stop angle C8 in the [P] mode.
14	Constant angle reverse run signal	USR	∷ ∷ ∷	Reverse run needle lift will be performed to the set angle. The set angle can be adjusted from the DOWN position to UP position with reverse run angle K8 in the [P] mode. This is effective for blind stitch sewing machine.
15	Needle lift, presser foot lift signal	UF	∷ ∷	If input UF is turned ON, the presser foot will lift after needle lifting.

25. Table of input/ output function for signal on C mode

No.	Setting name	Setting value		Specification
			Digital display	
16	Presser foot lifter signal	S3	Ⓢ ③	If input S3 is turned ON after trimming, the presser foot will lift. If input S3 is turned ON before trimming, the presser foot will lift, after delay time. The delay time is set by S3D the [P] mode of the 125 page.
17	Presser foot lifter signal	F	Ⓣ	If input F is turned ON, the presser foot lifter operation will start.
18	Needle UP position priority stop signal	PSU	Ⓟ ⑤ ④	If input PSU is turned ON while the sewing machine is running, the needle will stop at the UP position after swing PSU stitches and thread trimming. The no. of stitches after PSU input is set by PSU the [P] mode of 124 page.
19	Needle DOWN position priority stop signal	PSD	Ⓟ ⑤ ③	If input PSD is turned ON while the sewing machine is running, the needle will stop at the DOWN position after swing PSD stitches. The no. of stitches after PSD input is set by PSD the [P] mode of 124 page.
20	Emergency stop signal	ES	Ⓢ ⑤	If input ES is turned ON while the sewing machine is running, all running states will be canceled, and the sewing machine will stop with the brakes.
21	One shot signal	SH	Ⓢ ④	If input SH is turned ON, one shot operation will start. The operation mode set in [P] mode SHM function will be entered.
22	Reverse run signal	CW	Ⓢ ④	If input CW is turned ON while running with pedal toe down or external run signal, reverse run will be enabled while the signal is ON.
23	Thread trimmer protection signal	S6	Ⓢ ⑥	If input S6 is turned ON while the sewing machine is running, the sewing machine will stop. If input S6 is turned ON during thread trimming, the operation will be completed, and operation will not be possible until input S6 is turned OFF.
24	Thread trimmer cancel signal	TL	Ⓣ ④	If pedal full heeling or thread trimmer signal S2 is turned ON while input TL is ON, the thread will not be trimmed. After the thread trimmer interlock time passes, the presser foot lifting operation will start. When TL of [D] mode signal is turned ON a little time and TLS setting is ON, next thread trimming is prohibited at once.
25	Low speed signal	SPL	Ⓢ ④ ④	If input SPL is turned ON while the sewing machine is running, the sewing machine will run at the speed set in low speed setting L while the signal is ON.
26	Medium speed signal	SPM	Ⓢ ④ ⑤	If input SPM is turned ON while the sewing machine is running, the sewing machine will run at the speed set in medium speed setting M while the signal is ON.
27	End tacking speed signal	SPB	Ⓢ ④ ⑥	If input SPB is turned ON while the sewing machine is running, the sewing machine will run at the speed set in end tacking speed V while the signal is ON.
28	High speed signal	SPH	Ⓢ ④ ④	If input SPH is turned ON while the sewing machine is running, the sewing machine will run at the speed set in high speed setting H while the signal is ON.
29	Variable speed signal	SPV	Ⓢ ④ ④	If input SPV is turned ON while the sewing machine is running, the sewing machine will run at a speed proportional to the variable speed voltage VC while the signal is ON.
30	Tacking cancel signal	BTL	Ⓢ ④ ④	If input BTL is turned ON, start and end tacking will be prohibited while the signal is ON. When BTS of [D] mode is ON, and BTL signal is turned ON a little time, next tacking is prohibited at once.
31	Start tacking cancel signal	SB	Ⓢ ④	If input SB is turned ON, start tacking will be prohibited while the signal is ON. When BS of [D] mode is ON, and SB signal is turned ON a little time, next start tacking is prohibited at once.

25. Table of input/ output function for signal on C mode

No.	Setting name	Setting value		Specification
			Digital display	
32	End tacking cancel signal	EB	Ⓔ Ⓜ	If input EB is turned ON, end tacking will be prohibited while the signal is ON. When BS of [D] mode is ON , and EB signal is turned ON a little time , next end tacking is prohibited at once.
33	Backstitching during run signal	S7	Ⓔ Ⓜ	If input S7 is turned ON while the sewing machine is running, backstitching (reverse feed) will start. Nothing will happen if input S7 is turned ON while the sewing machine is stopped.
34	Backstitching during run signal	UDS	Ⓔ Ⓜ Ⓜ	If input UDS is turned ON while the sewing machine is running, backstitching (reverse feed) will start. Half-stitch operation will start if input UDS is turned ON while the sewing machine is stopped.
35	Backstitching during run signal	US	Ⓔ Ⓜ	If input US is turned ON while the sewing machine is running, backstitching (reverse feed) will start. Needle lift operation will start if input US is turned ON while the sewing machine is stopped.
36	Backstitching signal [when running when stopped]	BSL	Ⓔ Ⓜ Ⓜ	If input BSL is turned ON when the sewing machine is running or stopped, backstitching (reverse feed) will start.
37	Backstitching signal when running	UCR	Ⓔ Ⓜ Ⓜ	If input UCR is turned ON while the sewing machine is running, backstitching (reverse feed) will start. 1 stitch operation will start if input UCR is turned ON while the sewing machine is stopped.
38	Backstitching signal when running	UBR	Ⓔ Ⓜ Ⓜ	If input UBR is turned ON while the sewing machine is running, backstitching (reverse feed) will start. 1 stitch operation with backstitching (reverse feed) will start if input UBR is turned ON while the sewing machine is stopped.
39	Signal output to virtual output 1	IO1	Ⓔ Ⓜ Ⓜ	If input IO1 is turned ON, output OT1 will always be turned ON.
40	Signal output to virtual output 2	IO2	Ⓔ Ⓜ Ⓜ	If input IO2 is turned ON, output OT2 will always be turned ON.
41	Signal output to virtual output 3	IO3	Ⓔ Ⓜ Ⓜ	If input IO3 is turned ON, output OT3 will always be turned ON.
42	Signal output to virtual output 1 during operation	IR1	Ⓔ Ⓜ Ⓜ	If input IR1 is turned ON, output OT1 turns ON only when the sewing machine is running.
43	Signal output to virtual output 2 during operation	IR2	Ⓔ Ⓜ Ⓜ	If input IR2 is turned ON, output OT2 turns ON only when the sewing machine is running.
44	Signal output to virtual output 3 during operation	IR3	Ⓔ Ⓜ Ⓜ	If input IR3 is turned ON, output OT3 turns ON only when the sewing machine is running.
45	Signal output to virtual output 1 when stopped	IS1	Ⓔ Ⓜ Ⓜ	If input IS1 is turned ON, output OT1 turns ON only when the sewing machine is stopped.
46	Signal output to virtual output 2 when stopped	IS2	Ⓔ Ⓜ Ⓜ	If input IS2 is turned ON, output OT2 turns ON only when the sewing machine is stopped.
47	Signal output to virtual output 3 when stopped	IS3	Ⓔ Ⓜ Ⓜ	If input IS3 is turned ON, output OT3 turns ON only when the sewing machine is stopped.
48	Thread trimmer output confirmation signal	TON	Ⓔ Ⓜ Ⓜ	The thread trimmer output T can be turned ON or OFF only when the sewing machine is stopped. (Thread trimmer solenoid confirmation signal)
49	Needle cooler output during rotation forced [OFF] signal	NCL	Ⓔ Ⓜ Ⓜ	If input NCL is turned ON, the needle cooler output NCL during sewing machine rotation will forcibly be turned OFF.

25. Table of input/ output function for signal on C mode

No.	Setting name	Setting value		Specification
			Digital display	
50	1 position priority signal	P12	1 2 3	1 position will be set forcibly.
51	Weak brake [ON] signal	BK	4 5	If input BK is turned ON, the weak brake will turn ON. Use this with the BK of the [D] mode set to [OF].
52	Sensor input signal	SEN	6 7 8	This is the cloth edge sensor input.
53	Wiper output cancel signal	WL	9 10	If input WL is turned ON, the wiper output W will not be output.
54	Slow start signal	SL	11 12	If the SL signal is ON, the slow start operation will be valid. Use this with the normal mode [B,SL] key set to [OF].
55	Preset stitching forced [ON] signal	N	13	If input N is turned ON, preset stitching will start forcibly from that point.
56	Continuous tack stitching forced [ON] signal	CBT	14 15 16	If input CBT is turned ON, continuous backstitching will start forcibly from that point.
57	Non-stitching feed input	FWD	17 18 19	If input FWD is turned ON, output OT3, output NCL and output FU will be turned ON forcibly. Output ROL and output PUL will be turned OFF forcibly.
58	End tacking speed run signal	S5V	20 21 22	If input S5V is turned ON, the sewing machine will run at the speed set in end tacking speed V.
59	Counter clear signal	CCL	23 24 25	If input CCL is turned ON, it clears an up counter in [0] and it clears a down counter in [the setting value].
60	Thread break detector input signal	THI	26 27 28	It is possible to use as the input signal of thread break detector.
61	Signal output to virtual output 4	IO4	29 30 31	If input IO4 is turned ON, output OT4 will always be turned ON.
62	Signal output to virtual output 5	IO5	32 33 34	If input IO5 is turned ON, output OT5 will always be turned ON.
63	UP COUNT CLEAR	CCU		CLEARS UP COUNTER
64	DOWN COUNT CLEAR	CCD		CLEARS DOWN COUNTER

25. Table of input/ output function for signal on C mode

C mode output signal setting table

EN EMFY

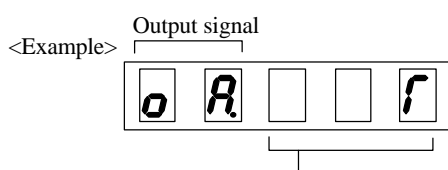

No.	Setting name	Setting value		Specification
			Digital display	
1	Output for slow start	SL	Ⓛ	During the no. of the setting stitches, SL output is turned ON. The setting no. of stitches can select SLN on [P] mode or HOF on [G] mode by setting SLH on [F] mode
2	Run output 1	OP	Ⓛ	OP output is turned ON while the sewing machine is running (not including needle lifting during thread trimming) .
3	Run output 2	OP1	Ⓛ 1	OP1 output is turned ON while the sewing machine is running. (not including needle lifting during thread trimming) OP1 output will turn ON during needle lifting when directly heeling.
4	Run output 3	OP2	Ⓛ 2	OP1 output is turned ON while the pedal is toed down, the external operation signal (S0, S1, SH), full pedal heeling or thread trimming signal (S2) is ON.
5	Output for run signal	S1	Ⓛ 1	S1 output is turned ON when the run signal is ON except during on 1 stitch sewing.
6	Output for blower	VAC	Ⓛ 2	VAC output is turned ON during pedal full heeling or while thread trimmer signal S2 is ON.
7	Output for needle cooler	NCL	Ⓛ 1	NCL output is turned ON while the sewing machine is running (including needle lifting).
8	Output for vacuum signal	VCM	Ⓛ 2	VCM output is turned ON during pedal full heeling or while thread trimmer signal S2 is ON while the sewing machine is stopped.
9	Output for signal during tacking	BT	Ⓛ 1	BT output is turned ON during tacking.
10	Roller lift output	ROL	Ⓛ 1	ROL output is turned ON when presser foot lifter output FU is ON, backstitching output B is ON, or when input IO2 signal is ON. ROL output is turned ON while tacking and while thread trimming if RLM of [F] mode is ON.
11	Thread trimmer output	T	Ⓛ 1	Thread trimming starts.
12	Thread release output	L	Ⓛ 1	Thread release operation starts.
13	Wiper output	W	Ⓛ 1	Wiper operation starts.
14	Backstitch output (Condensed stitch)	B	Ⓛ 1	Backstitching (reverse feed) starts. (Condensed stitch)
15	[CH2] output	CH	Ⓛ 2	CH2 output for chain stitches.
16	[TF] output	TF	Ⓛ 1	TF output for chain stitches. Refer to pages 183 for the output timing.
17	[KS1] output	KS1	Ⓛ 1	Behind operation signal ON, KS1 output is turned ON after the setting delay time. Refer to "Output KS1, KS2, KS3 timing".
18	[KS2] output	KS2	Ⓛ 2	After the motor stopped, KS2 output is turned ON after the setting delay time. Refer to "Output KS1, KS2, KS3 timing".
19	[KS3] output	KS3	Ⓛ 3	After trimming and stopped up position, KS3 output is turned ON after setting delay time. Refer to page 183 for the output timing.
20	[TB] output	TB	Ⓛ 1	TB output for chain stitches. Refer to "Output TB, TF timing".
21	Presser foot lifter output	FU	Ⓛ 1	Presser foot lifter operation starts. The operation mode set in the [P] mode FUM function and FU function will be entered.

25. Table of input/ output function for signal on C mode

No.	Setting name	Setting value		Specification
			Digital display	
22	Output for UP position when stopped	UC	Ⓜ Ⓢ	UC output is turned ON if at the needle UP position when the sewing machine is stopped.
23	Needle UP position output	UPW	Ⓜ Ⓢ Ⓜ	UPW output is turned ON if at the UP position when the, sewing machine is stopped, and while moving from the UP position to the DOWN position when the sewing machine is running.
24	Needle DOWN position output	DNW	Ⓜ Ⓢ Ⓜ	DNW output is turned ON if at the DOWN position when the, sewing machine is stopped, and while moving from the DOWN position to the UP position when the sewing machine is running.
25	Virtual output 1	OT1	Ⓜ Ⓢ Ⓜ	OT1 output is turned ON according to each input specifications while inputs IO1, IR1 and IS1 are ON.
26	Virtual output 2	OT2	Ⓜ Ⓢ Ⓜ	OT2 output is turned ON according to each input specifications while inputs IO2, IR2 and IS2 are ON.
27	Virtual output 3	OT3	Ⓜ Ⓢ Ⓜ	OT3 output is turned ON according to each input specifications while inputs IO3, IR3 and IS3 are ON.
28	Output for error occurrence confirmation	ERR	Ⓜ Ⓢ Ⓜ	This is output when an error occurs. (Note that this is not output when error code E9 occurs.)
29	Output for power [OFF] confirmation	IPF	Ⓜ Ⓢ Ⓜ	Not used.
30	[OT4]output	OT4	Ⓜ Ⓢ Ⓜ	OT4 output is turned ON according to each input specification while input IO4 is ON.
31	[OT5]output	OT5	Ⓜ Ⓢ Ⓜ	OT5 output is turned ON according to each input specification while input IO5 is ON.
32	Puller output	PUL	Ⓜ Ⓢ Ⓜ	PUL output is turned ON during the presser foot lifter operation, during the IO2 output is ON.
33	Count up output	CUP	Ⓜ Ⓢ Ⓜ	When + 1 up counter does, the [CUP] output is turned on.
34	Thread break detector output	THO	Ⓜ Ⓢ Ⓜ	When detecting thread break detector, THO output is turned ON. (When re-operation, the signal is turned off)
35	Vacuum output for holding thread	FUW	Ⓜ Ⓢ Ⓜ	FUW output is turned ON during the presser foot lifter operation or during wiper operation.
36	Always ON output	HI	Ⓜ Ⓢ Ⓜ	In case of the power on, [HI] output is always ON.
37	[NO] output	NO	Ⓜ Ⓢ Ⓜ	Nothing is output.
38	[CUE] output	CUE	Ⓜ Ⓢ Ⓜ	This output becomes ON when Up-counter becomes end. This output becomes OFF when "CCL" input is turned on.
39	[CDE] output	CDE	Ⓜ Ⓢ Ⓜ	This output becomes ON when Down-counter becomes end. This output becomes OFF when "CCL" input is turned on.