

[1] Sewing machines for each item

JEANS	2
Jeans pants.....	2
Jeans jacket.....	3
MEN'S WEAR	4
Men's jacket.....	4
Men's trousers.....	5
Men's dress shirts.....	6
LADIES' WEAR	7
Ladies' jacket.....	7
Skirt.....	8
Ladies' pants.....	9
Ladies' blouse B (Short sleeve).....	10
SPORTS WEAR	11
Training jacket.....	11
Training pants.....	12
Polo shirts.....	13
UNDER WEAR	14
T- shirts.....	14
Men's trunks.....	15
UNDER WEAR	16
Men's brief · Panty.....	16
FOUNDATION	17
Brassiere · Girdle.....	17

JEANS

Jeans pants

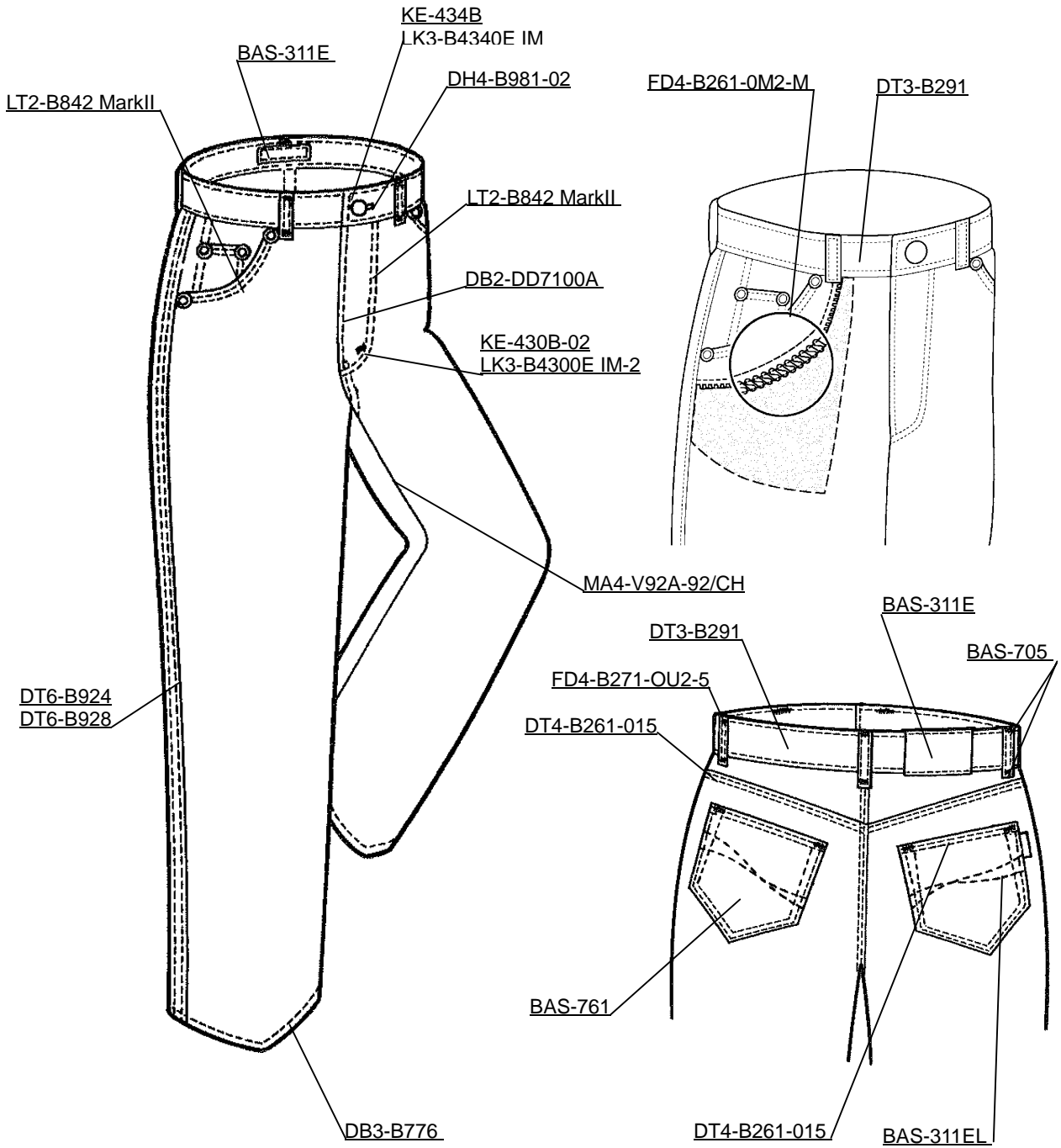

JEANS

Jeans jacket

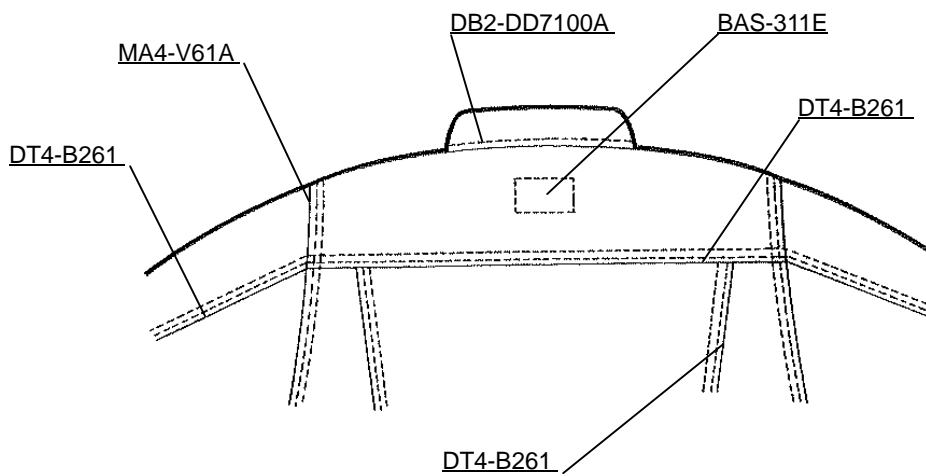
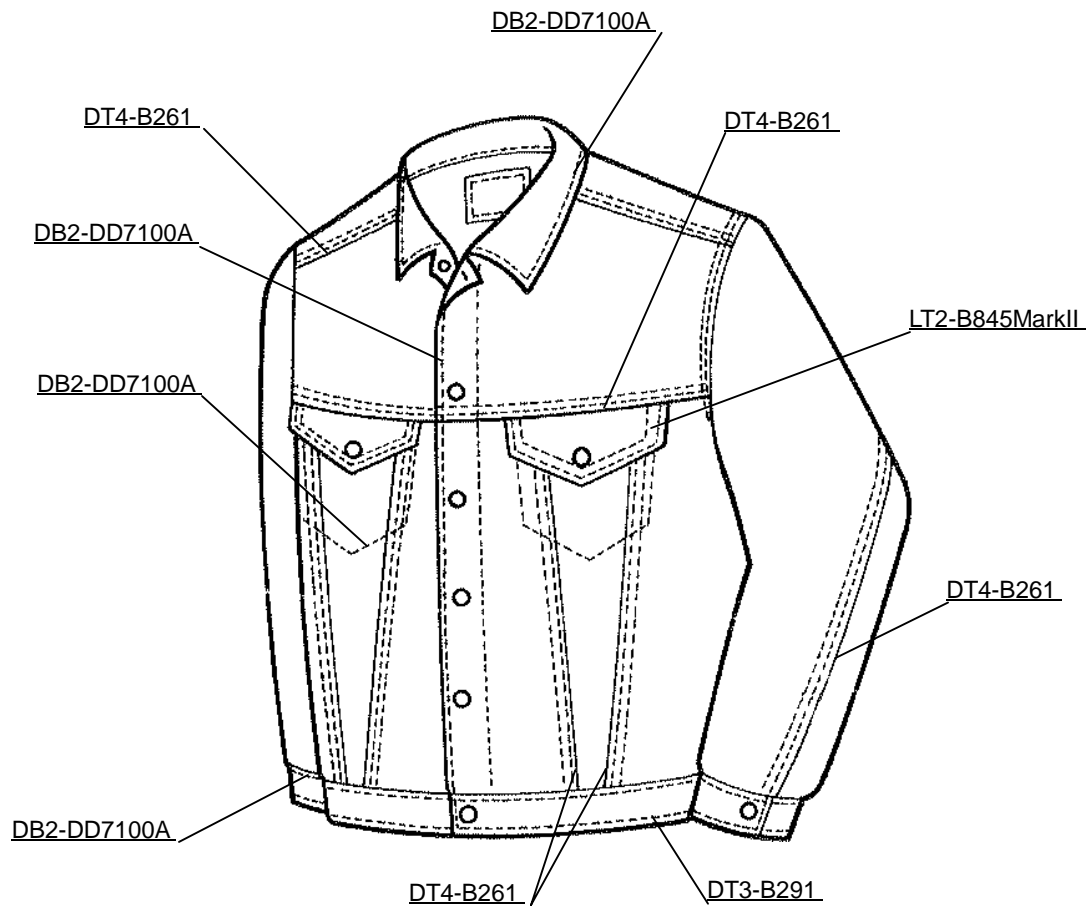

MEN'S WEAR

Men's jacket

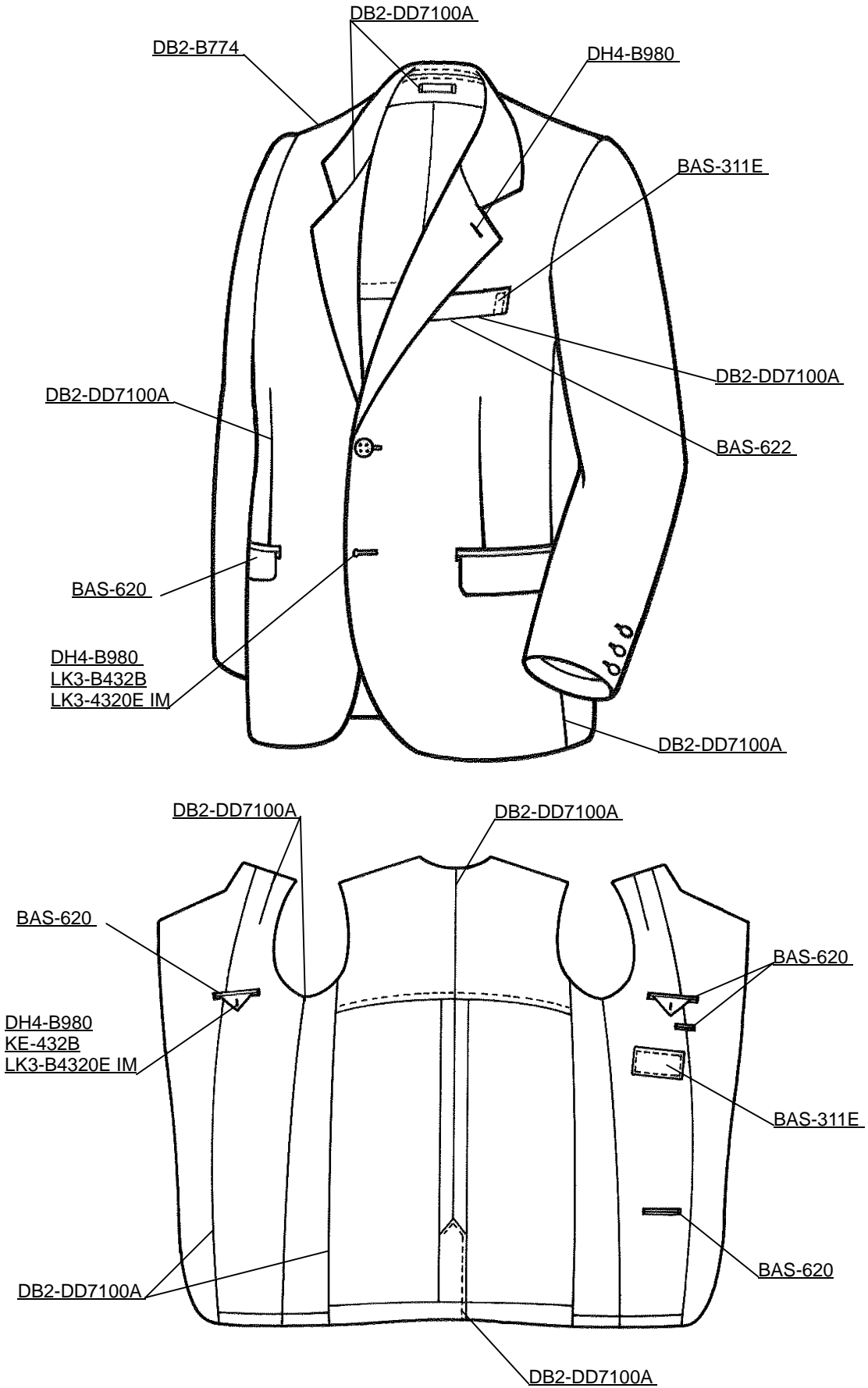

MEN'S WEAR

Men's trousers

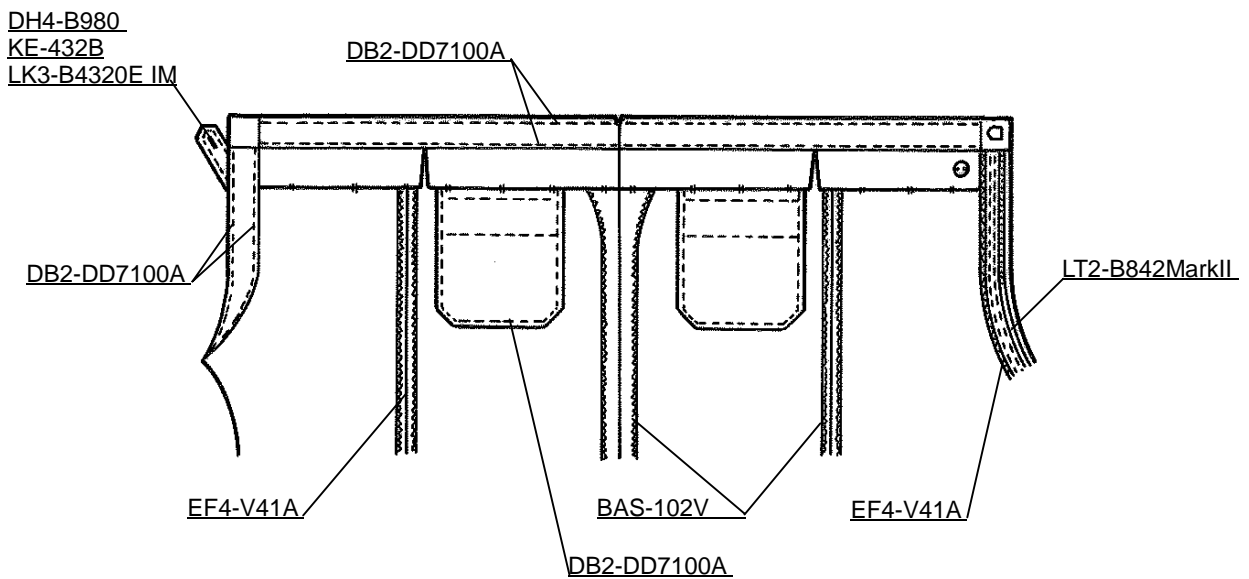
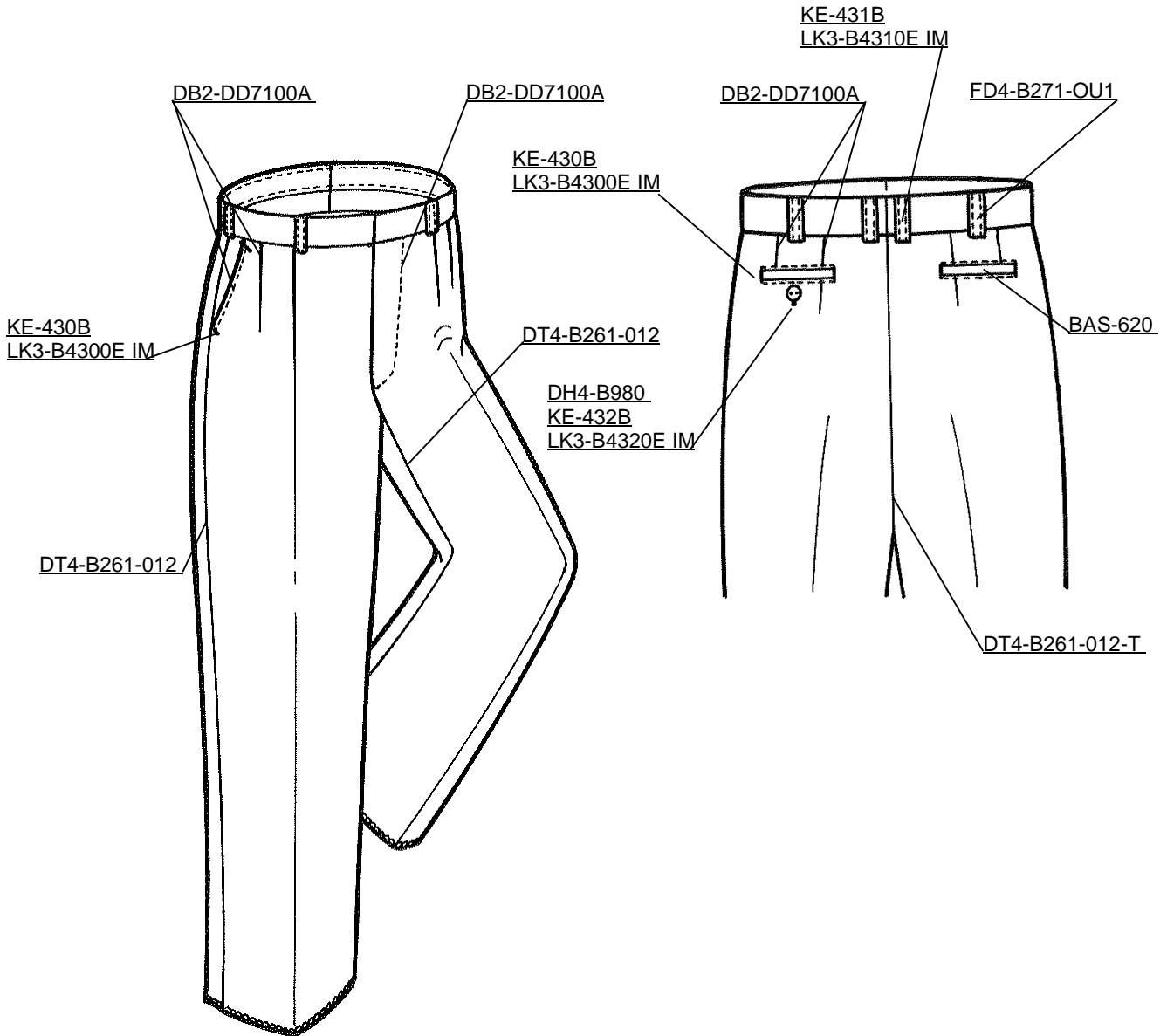

MEN'S WEAR

Men's dress shirts

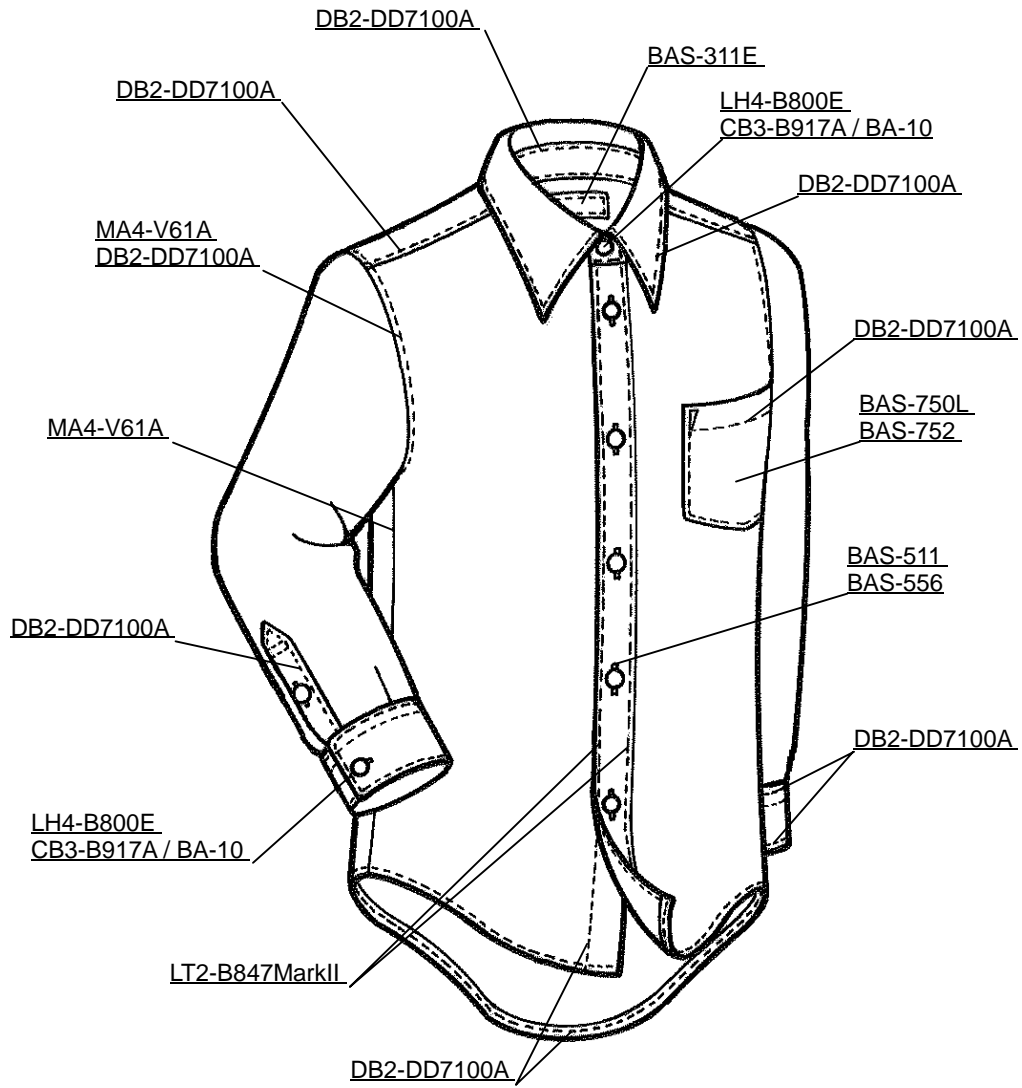

LADIES' WEAR

Ladies' jacket

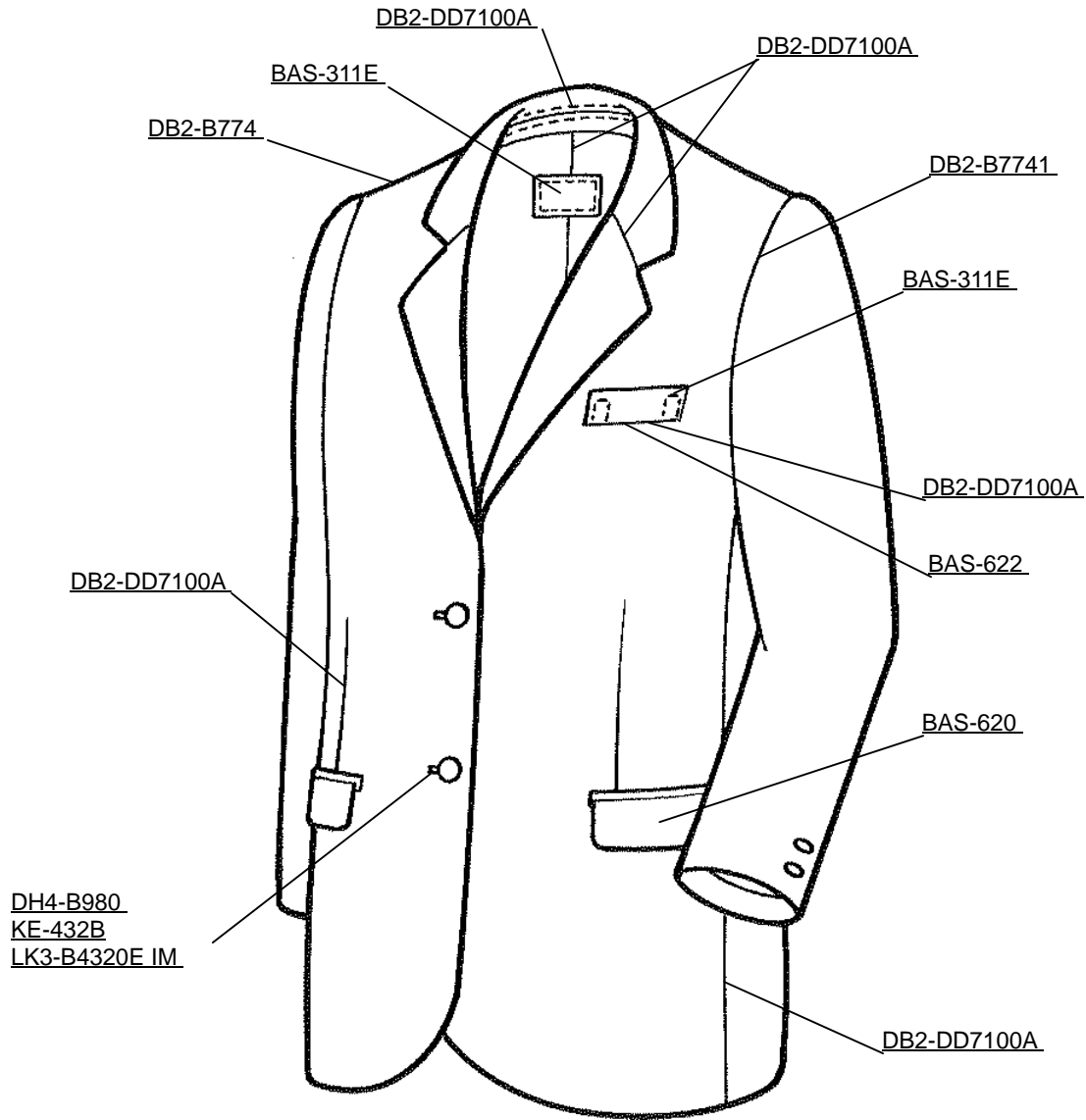

LADIES' WEAR

Skirt

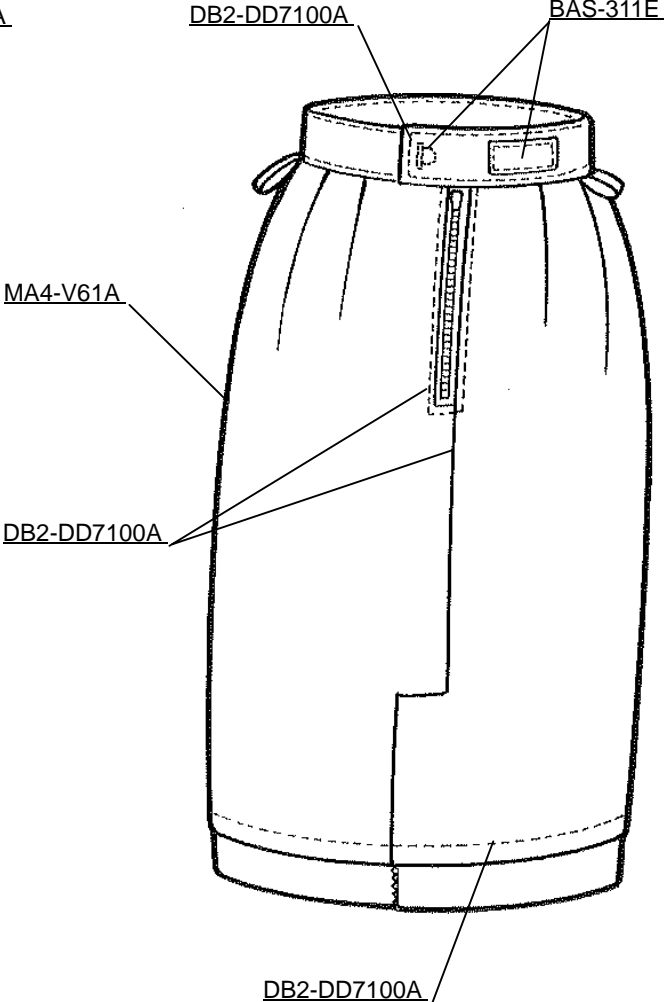
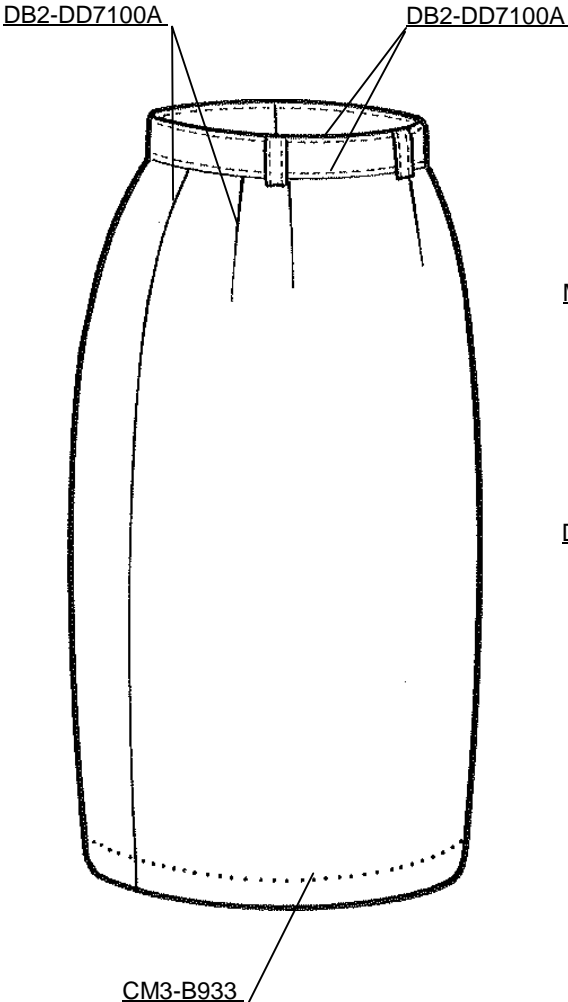

LADIES' WEAR

Ladies' pants

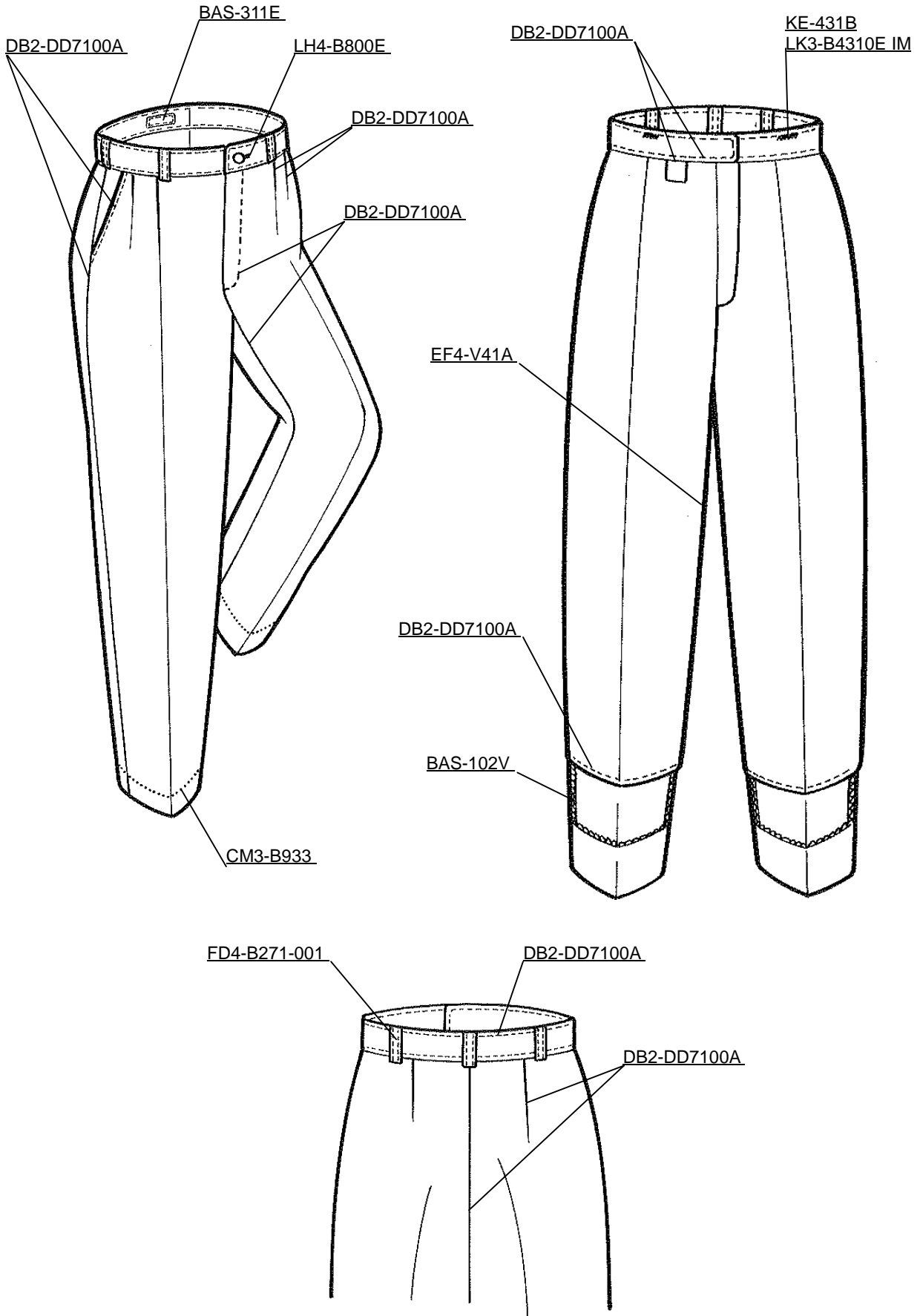

LADIES' WEAR

Ladies' blouse B (Short sleeve)

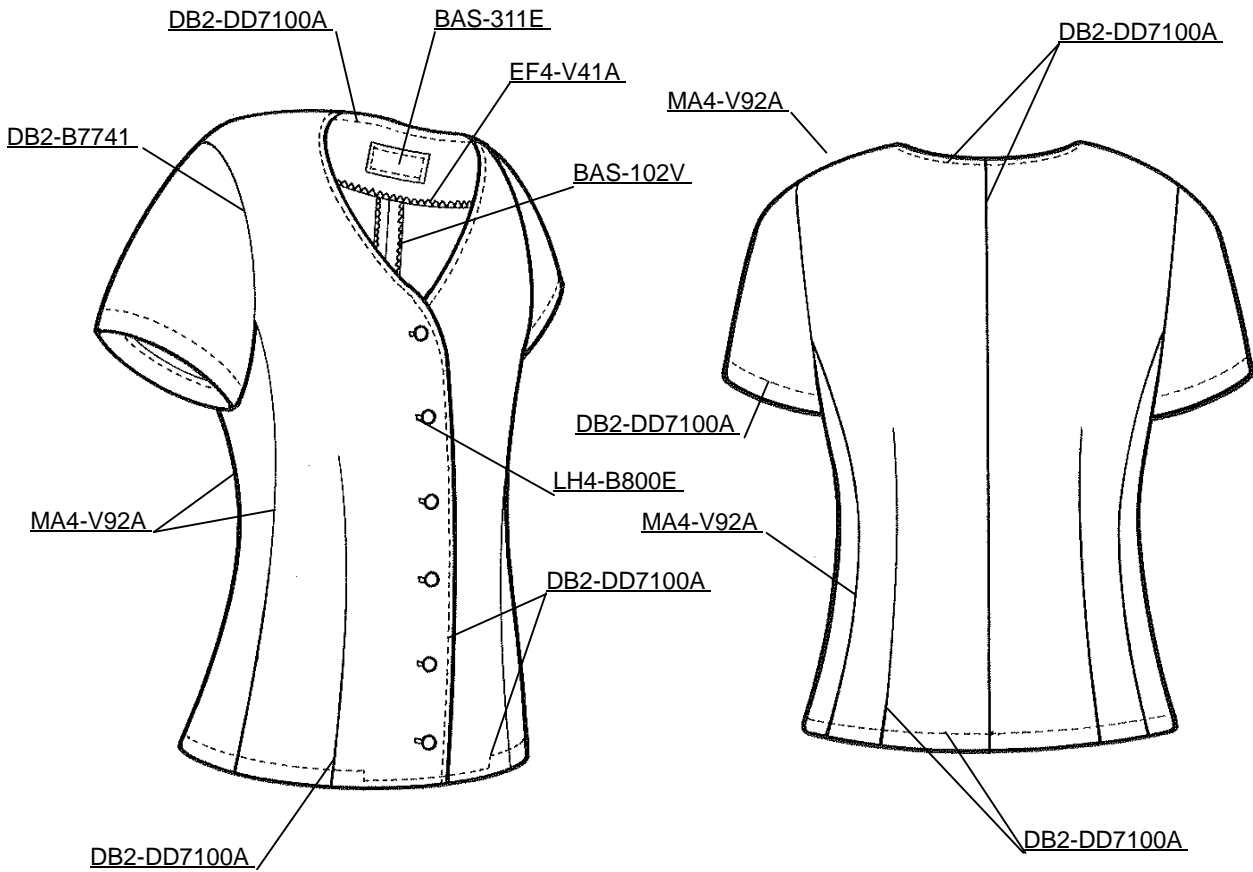

SPORTS WEAR

Training jacket

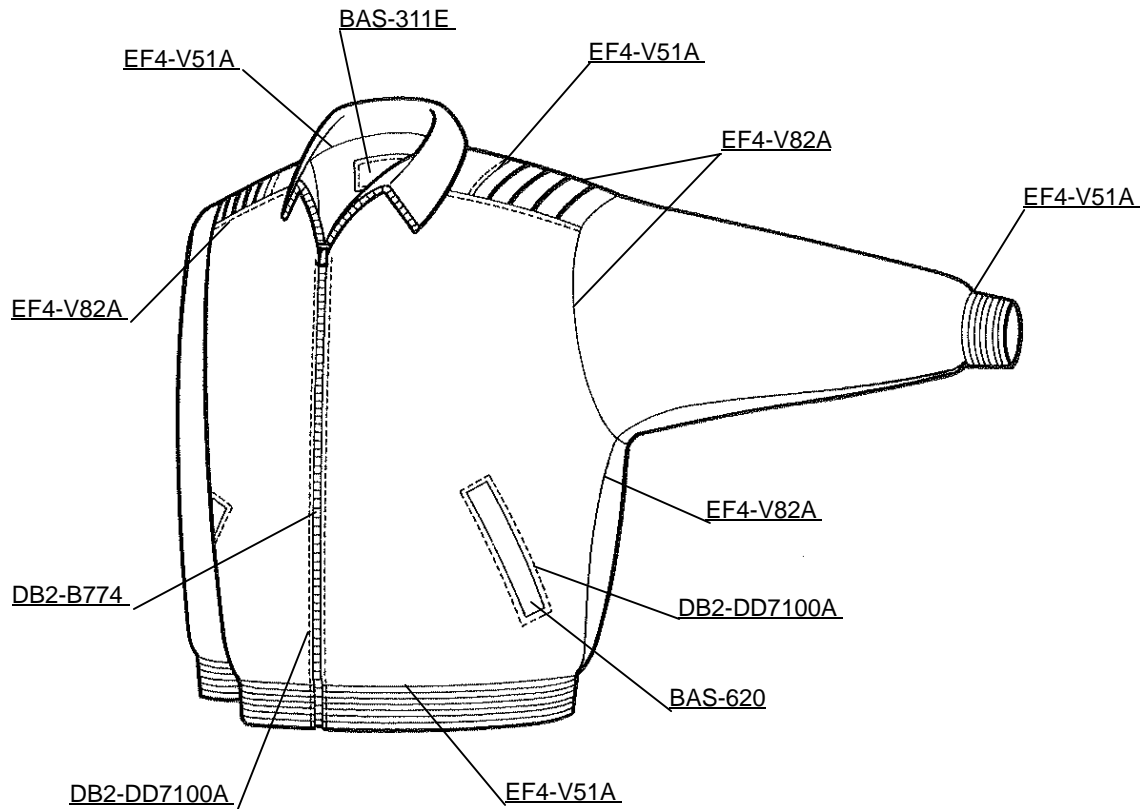

SPORTS WEAR

Training pants

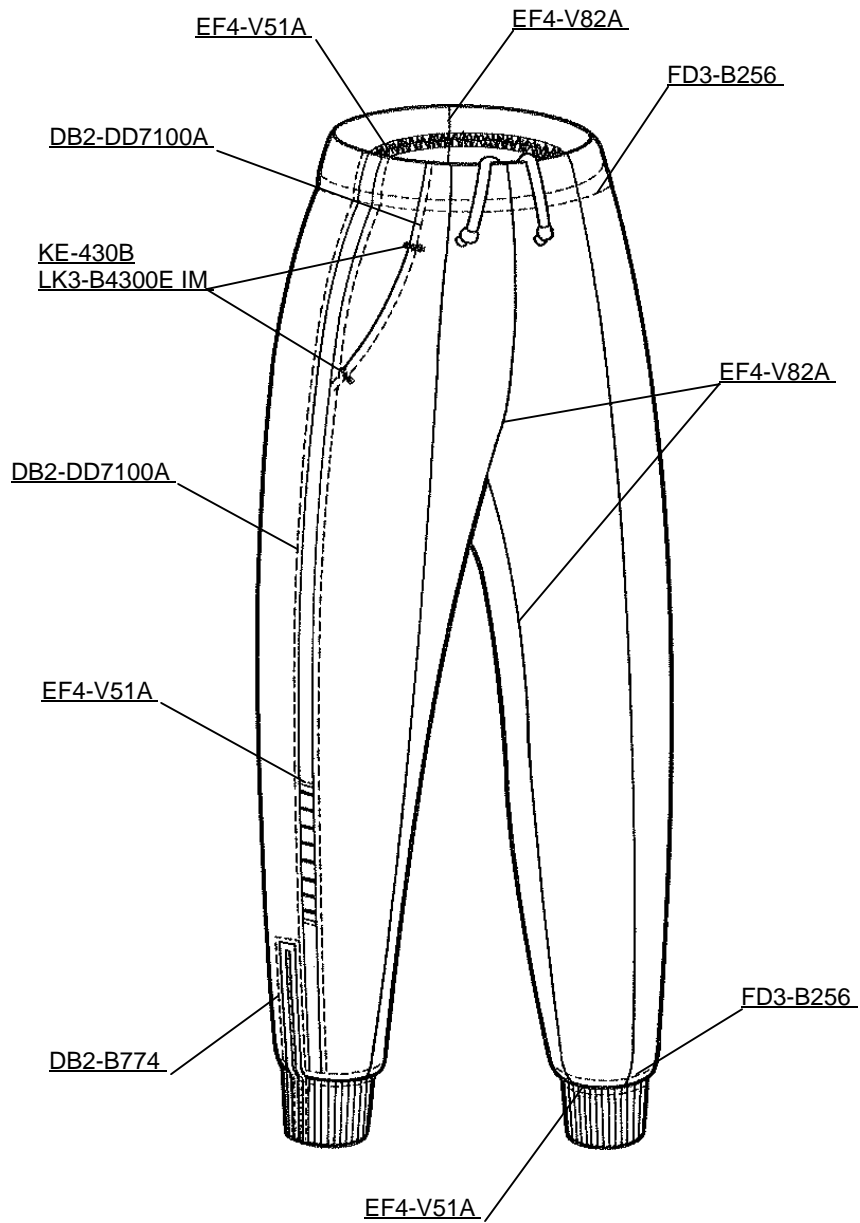

SPORTS WEAR

Polo shirts

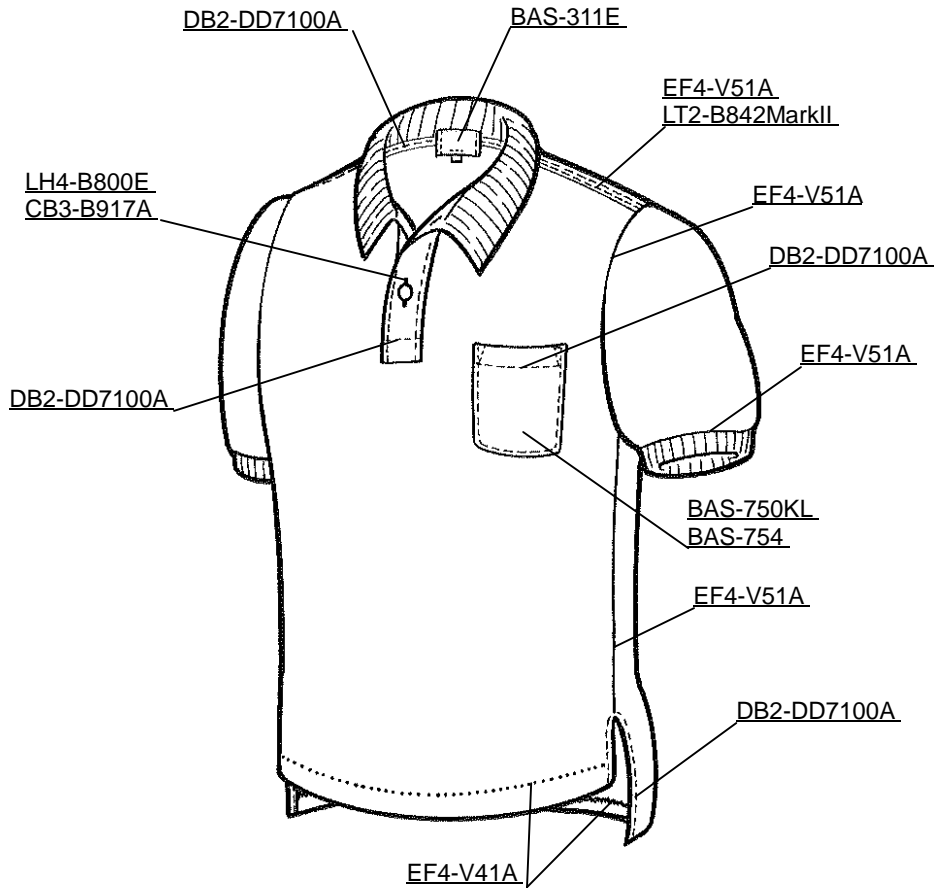

UNDER WEAR

T- shirts

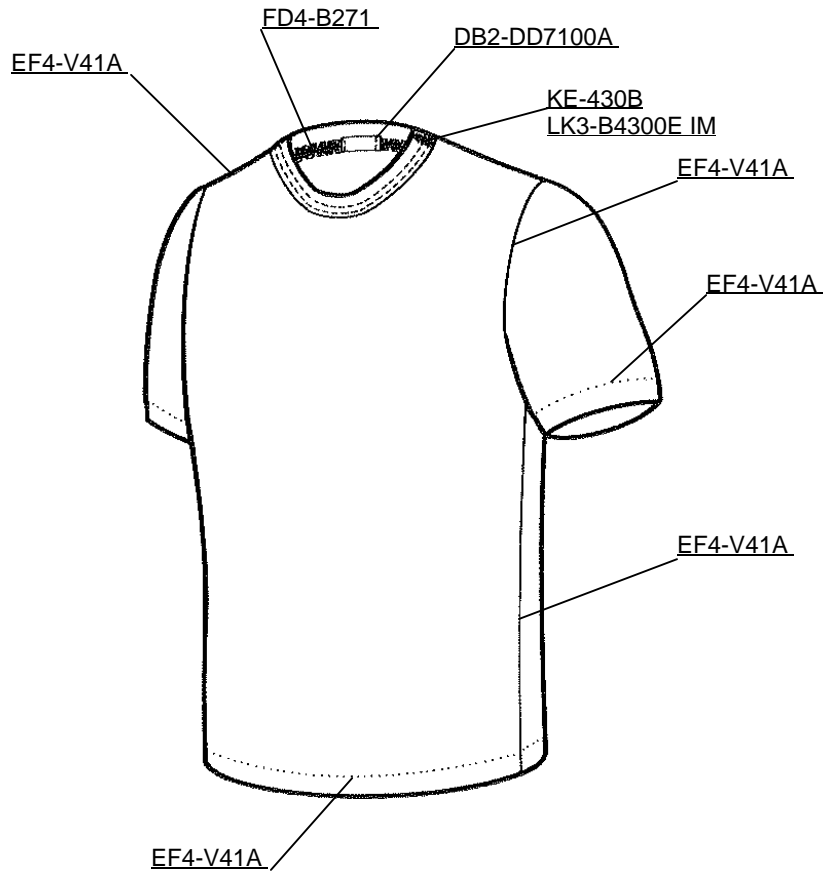

UNDER WEAR

Men's trunks

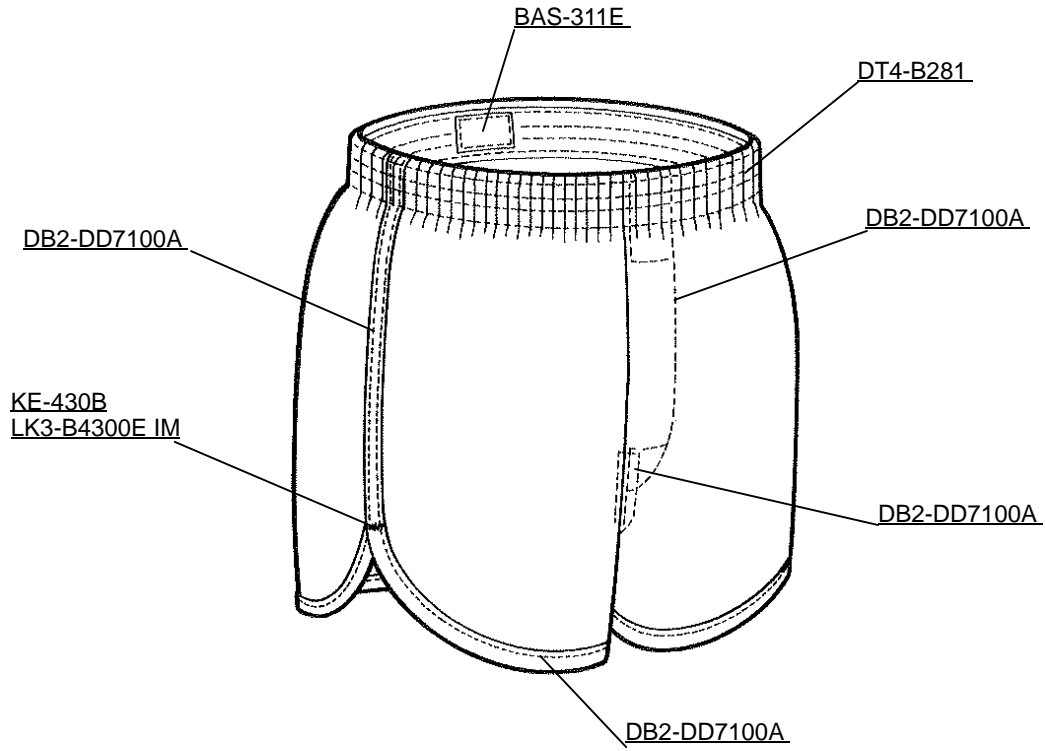

UNDER WEAR

Men's brief - Panty

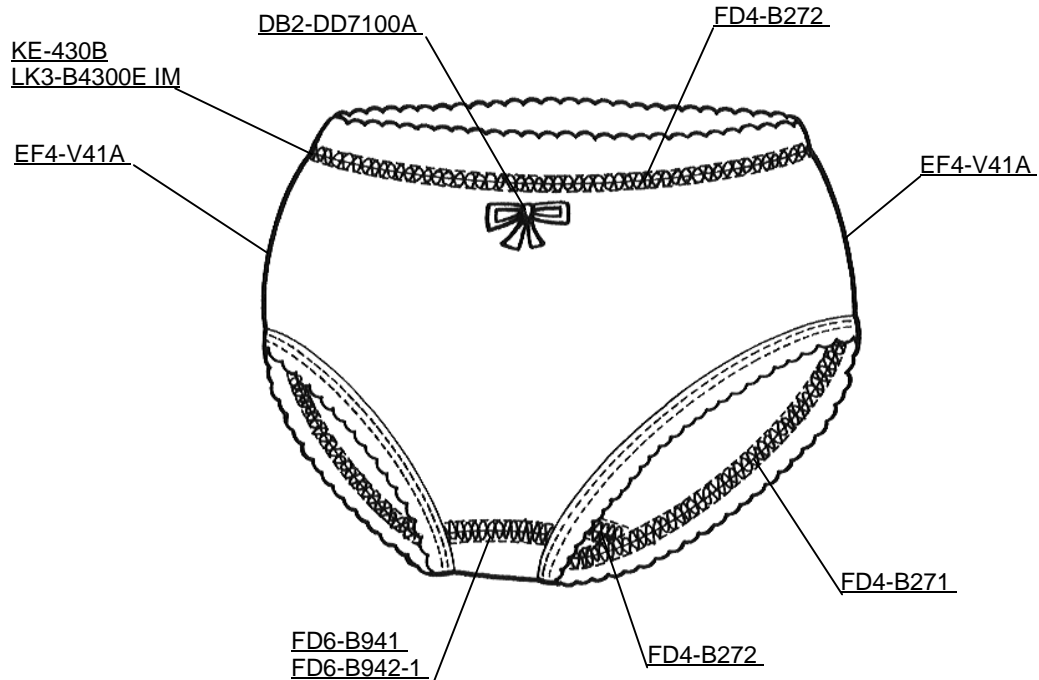
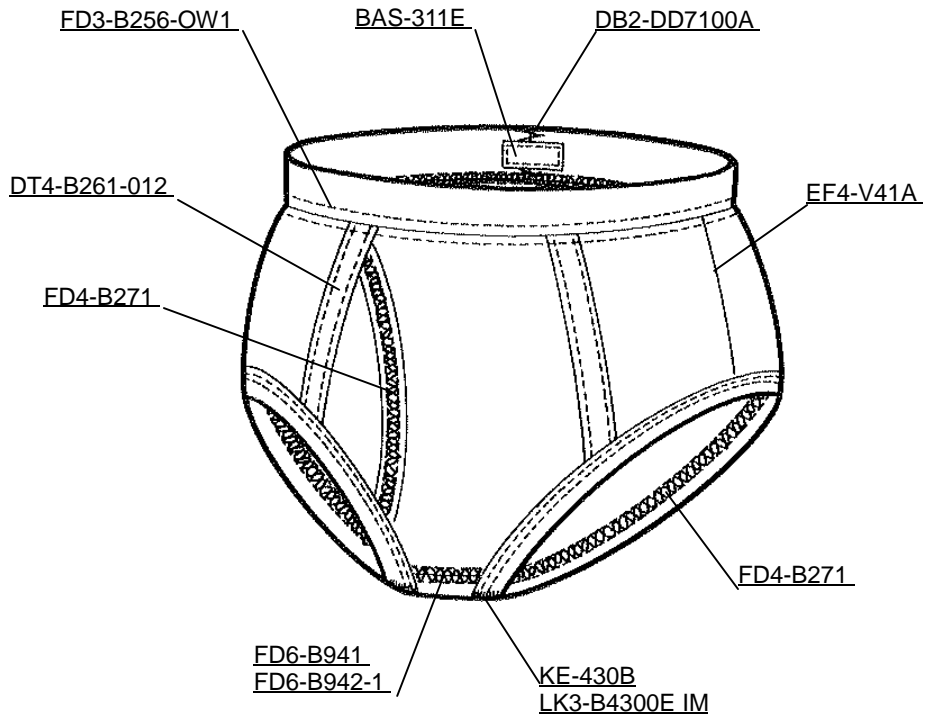

FOUNDATION

Brassiere - Girdle

