

# KE-436 B

## Electronic Lockstitch Pattern Tacker with Stepping Foot and Programming function

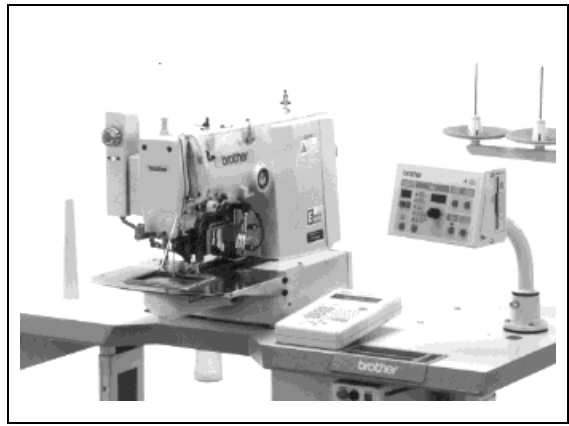

### Specifications

Stitch formation	Single needle lock stitch
Maximum sewing speed	2,500 rpm (Pitch 3 mm)
Maximum pattern size (X x Y)	100 x 60 mm max.
Feed mechanism	R-0Intermittent feed mechanism (pulse-motor driven mechanism)
Stitch length	0.1 – 10.0 mm
No. of stitches	Variable
Maximum number of stitches	20,000 stitches (One pattern)
Work clamp lifter	Pneumatic type
Work clamp height	25 mm max.
Rotary hook	Shuttle hook 2 (Shuttle hook, optional)
Wiper device	Standard equipment
Thread trimmer device	Standard equipment
Thread take-up device	Standard equipment
Stepping foot lift amount	18 mm
Stepping foot stroke	0 mm, 3 – 8 mm
Safety device	Built-in stopping mechanism
Data storage method	3.5 floppy disk 2HD / 1.44MB, 2DD
Motor	Three-phase 400 W induction motor
Weights	Machine head: 56 kg, Operation panel: 2.8 kg, Control box: 10 – 20 kg (depending on destination)
Power source	Single-phase 110V, 220 – 230 V, 240V 3-phase 220 V, 380 V, 400 V Maximum electric power consumption; 600 VA

### Main use

\*Patterns up to a maximum size of 100 mm x 60 mm can be sewn.

For plain stitching of small articles, curtain darts, etc.

\*Two-stage work clamp, light work clamp and inner clamping device (optional) can be used.

For attaching items, sewing labels, etc.

# Optional parts Foot switch pedal mechanism

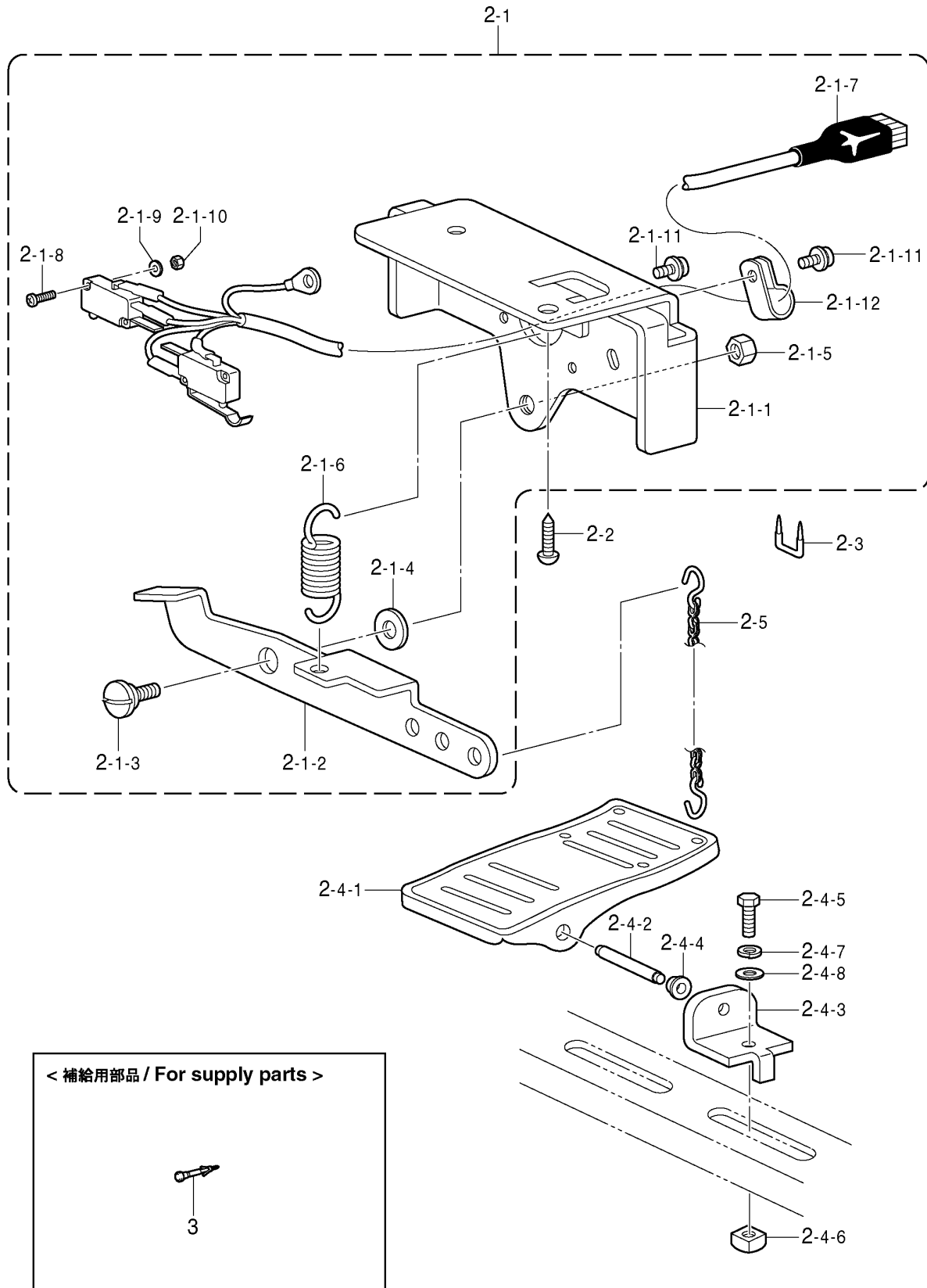





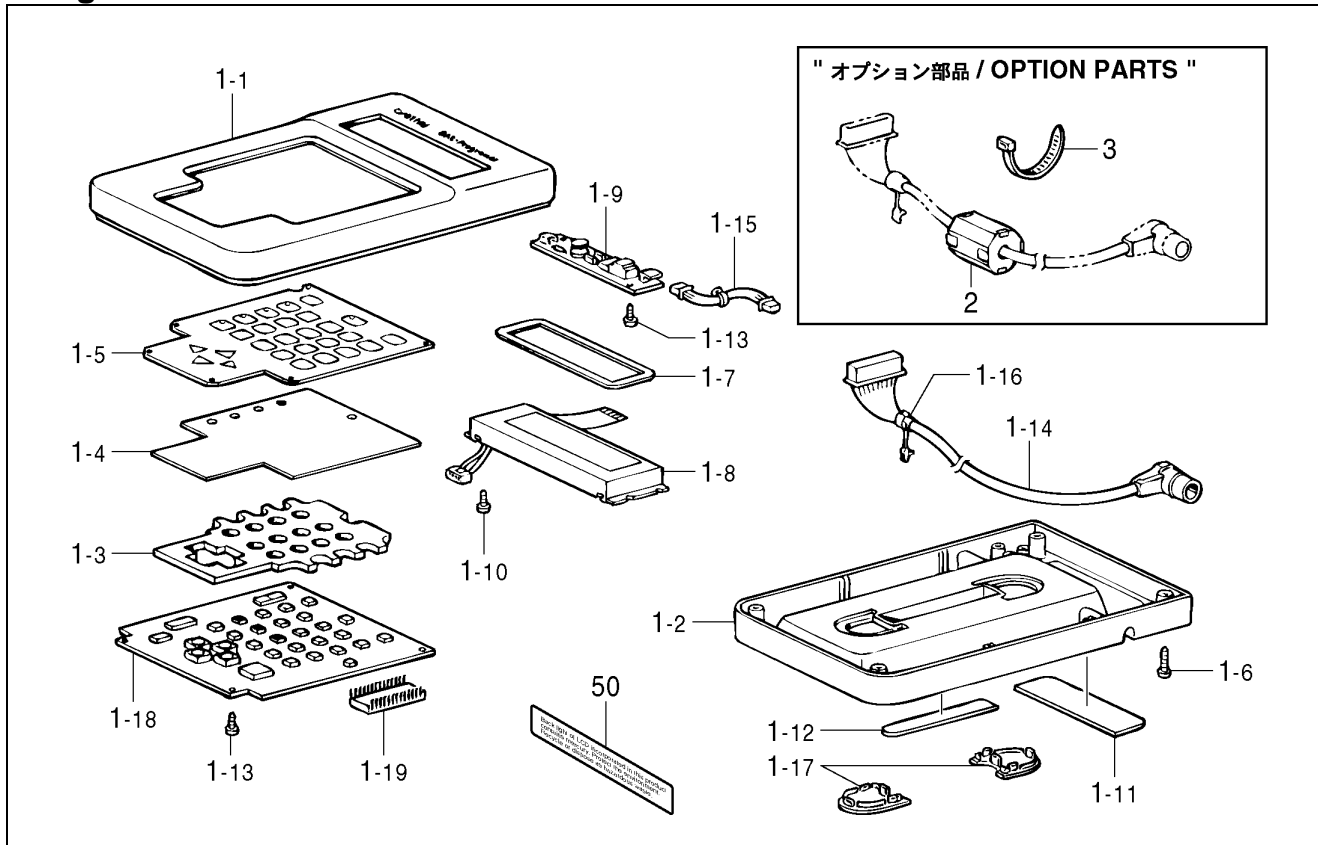







Ref. No.	Part name	Part code	Q'ty
2	2-step foot switch set, OP	S46131-001	1
2-1	2-step foot switch assy, OP	S46132-001	1
2-1-1	Switch bracket	S46133-001	1
2-1-2	Foot SW lever	S46134-001	1
2-1-3	Shoulder screw, SM7.94	148904-001	1
2-1-4	Washer, plain M8	025080-236	1
2-1-5	Nut, SM7.94	101268-002	1
2-1-6	Sprig, extension	S46135-001	1
2-1-7	Foot SW harness assy	S46136-001	1
2-1-8	Screw, pan (S / P washer) M3 × 20	UD2390-001	4
2-1-9	Washer, plain M3	025030-236	2
2-1-10	Nut, 2 M3	021300-206	2
2-1-11	Screw, pan (S / P washer) M4 × 8	052400-806	2
2-1-12	Cord holder, 5 N	S00480-000	1
2-2	Wood screw, round M5.5 × 20	100666-002	2
2-3	Staple	200190-001	3
2-4	Treadle assy	S01603-009	1
2-4-1	Treadle pedal	S01199-003	1
2-4-2	Treadle shaft	133188-001	1
2-4-3	Bracket	119707-003	2
2-4-4	Collar	119708-001	2
2-4-5	Bolt, M8 × 22	017082-206	2
2-4-6	Nut, M8	116694-001	2
2-4-7	Washer, spring 2 - 8	028080-240	2
2-4-8	Washer, plain M8	025080-236	2
2-5	Chain assy	142656-001	1
	<For supply parts>		
3	Contact, ; 170364-1	S49443-000	1

# Optional parts Programmer



Ref. No.	Part name	Part code	Q'ty
1	Programmer assy	S43249-001	1
1-1	Top cover, ;programmer	S43250-000	1
1-2	Lower cover, ;programmer	S43251-000	1
1-3	Spacer, ;keyboard	S43252-000	1
1-4	Rubber sheet, ;keyboard	S43253-000	1
1-5	Keyboard sheet	S43254-000	1
1-6	Tapping screw, pan V M3 × 10	037301-015	4
1-7	LCD cover	S43255-000	1
1-8	LCD	S43256-000	1
1-9	Inverter, LCD	S43257-000	1
1-10	Tapping screw, pan V M2 × 6	037200-615	40
1-11	Magnet, A	S43271-000	1
1-12	Magnet, B	S43272-000	1
1-13	Screw, 3 × 6	037300-615	6
1-14	Programmer harness	S43267-000	1
1-15	Inverter harness	S43268-000	1
1-16	Cord bush, ;KR51	S43270-000	1
1-17	Lower cover, programmer	S43981-000	2
1-18	Programmer PCB assy	S43259-001	1
1-19	PROM programmer assy	S43269-000	1
	<For area limitation>		
2	EMI core, ESD-SR-15	S40621-000	1
3	Beard band, L = 200	149809-000	1
	<For area limitation>		
50	Mercury warning label 14 × 70 P2	S52582-001	1



## Different parts list

Spec. Part name	Medium materials	Heavy materials	Extra heavy materials
Needle hole plate 	( $\phi$ 2.2) S49980-001 FM	( $\phi$ 2.6) S10212-101 E	★
Bobbin case assy 	159610-301 A	152690-401 B	★
		S15902-401 LA	★
Tension spring 	154339-101 A	154340-101 B	★
		S16074-101 LA	★
Screw 		154341-001	★
		S16492-101 LA	★
Spring, anti-spin 	159612-001 A ★	154342-001 B	★
		S15667-001 LA	★
Bobbin 	159613-051	★	154663-001 B ★
		S44633-001 LAN	★
Shuttle hook assy w/box 	152685-903 A ★	152687-902 B	★
	S15662-992 LA ★	S15663-991 LB	★
Shuttle race body 	152682-101 A ★	152686-101 B	★
Spring, tension 	104525-001 ★	107606-001 ★	S06548-001 C
Thread take-up spring 	145519-001 ★	144588-001 B	★
Needle bar thread guide  	S41222-101 B ★	S02438-001 A ☆	S02439-001 B ★

★: Common with the LK3-B430E.

☆: Common with the BAS-311E.

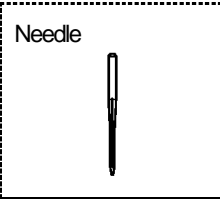
## Different parts list

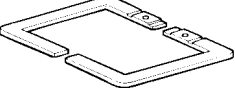
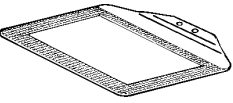
Spec. Part name	Medium materials	Heavy materials	Extra heavy materials
Needle assy 	107415-414 ★	S37928-419 ★	145646-425 ☆
Needle 	DP × 5 #14 107415-014 ★	DP × 17 NY #19 S37928-019 ★	DP × 17 #25 145646-025 ☆
Work clamp 	-	434ESF-2R S46544-001	-
		S434ESF-2L S46545-001	
Feed plate 	-	434ESF-2 S44942-001	-

★: Common with the LK3-B430E.

☆: Common with the BAS-311E.

# Gauge parts list

Optional gauges are listed in the following table.

Each work clamp pair is used in combination with the feed plate directly below them.

	1	2	3	4
R	153493-001	S23377-001 (519)	S27836-001 (895)	156085-001 (M)
L	153498-001	S23378-001 (519)	S27837-001 (895)	156086-001 (M)
Work clamp,				
Feed plate	153503-001 	S23379-001 (519) 	S27838-001 (895) 	156087-001 (M) 

	5	6	7		
R	156082-001 (L)	156088-001 (S)	S44940-001 (434E SF)		
L	156083-001 (L)	156089-001 (S)	S44941-001 (434E SF)		
Work clamp,					
Feed plate	156084-001 (L) 	156090-001 (S) 	S43990-001 (A)	S43991-001 (B)	S43992-001 (C) 
			A: t=0.5 B: t=1.0 C: t=2.0		

## Gauge assy, 434E MK2

Gauge assy, 434E MK2	
S54984-001	
Home position standard plate 	Screw 

# Gauge parts list

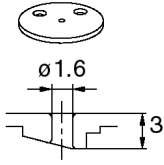
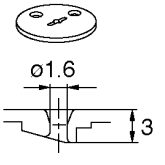
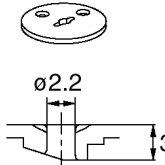
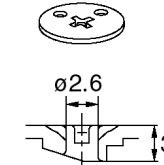
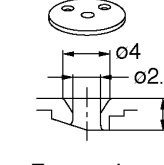
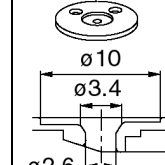
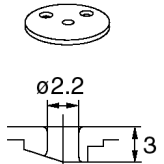
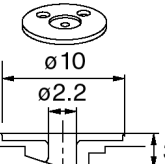
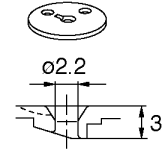
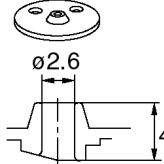
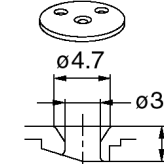
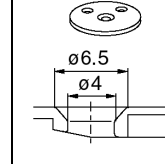
Needle hole plate											
A	S10211-001	AF	S51449-001	BZ	S41013-001	D	S29997-001	E	S10212-101	ED	S30925-001
							For extra heavy & heavy materials				
F	S10213-001	FD	S30926-001	FM	S49980-001	H	S30450-001	L	S25127-001	M	S34348-001
							For medium materials				
3	S40217-001										
	